



ADVANCED MANUAL

VHF/UHF ALL MODE TRANSCEIVER

IC-9700

This manual describes instructions for advanced features and instructions.
See the BASIC MANUAL that come with the transceiver for precautions and basic operations.

INTRODUCTION

1 ADVANCED OPERATIONS

2 SCOPE OPERATION (ADVANCED)

3 VOICE RECORDER FUNCTIONS

4 VOICE TX MEMORY FUNCTION

5 MEMORY OPERATION

6 SCANS

7 OTHER FUNCTIONS

8 GPS OPERATION (BASIC)

9 GPS OPERATION (ADVANCED)

10 D-STAR OPERATION (BASIC)

11 D-STAR OPERATION (ADVANCED)

12 ABOUT THE DV GATEWAY FUNCTION

13 DD MODE OPERATIONS

14 UPDATING THE FIRMWARE

INTRODUCTION

Thank you for choosing this Icom product. This product is designed and built with Icom's state of the art technology and craftsmanship. With proper care, this product should provide you with years of troublefree operation.

This product combines traditional analog technologies with the new digital technology, Digital Smart Technologies for Amateur Radio (D-STAR), for a balanced package.

ABOUT THE MANUALS

(As of May 2023)

You can use the following manuals to understand and operate this transceiver.

- **Basic Manual (Comes with the transceiver)**
Instructions for basic operations.
- **Advanced Manual (This manual)**
Instructions for advanced operations.
- **CI-V Reference Guide (PDF type)**
Describes the control commands used in remote control operation (serial communication with CI-V).
- **About the Picture Shares function (PDF type)**
Describes how to use the Picture Shares function.

For Reference

- **HAM Radio Terms (PDF type)**
A glossary of HAM radio terms.

Icom and the Icom logo are registered trademarks of Icom Incorporated (Japan) in Japan, the United States, the United Kingdom, Germany, France, Spain, Russia, Australia, New Zealand and/or other countries.

APRS® is a registered trademark of Mr. Bob Bruninga in the U.S.A. and other countries.

Microsoft and Windows are registered trademarks of Microsoft Corporation in the United States and/or other countries.

Google, the Google Logo, Google Play, the Google Play logo, Android, and the Android logo are trademarks of Google, LLC. Adobe, Acrobat, and Reader are either registered trademarks or trademarks of Adobe Systems Incorporated in the United States and/or other countries.

All other products or brands are registered trademarks or trademarks of their respective holders.

Functions and features of Adobe® Acrobat® Reader®

The following functions and features can be used with Adobe® Acrobat® Reader®.

• **Keyword search**

Click “Find (Ctrl+F)” or “Advanced Search (Shift+Ctrl+F)” in the Edit menu to open the search screen. This is convenient when searching for a particular word or phrase in this manual.

*The menu screen may differ, depending on the Adobe® Acrobat® Reader® version.

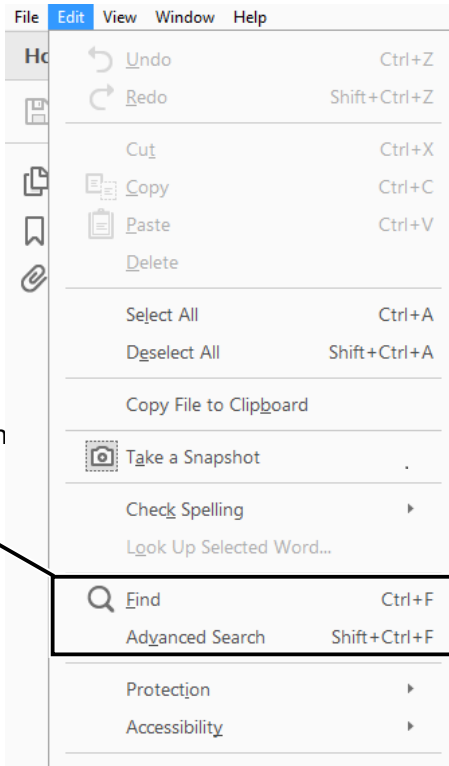

Click to open the find or search screen or advanced search screen.

• **Find screen**

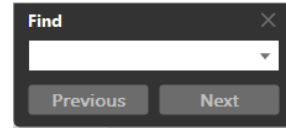

• **Advanced search screen**

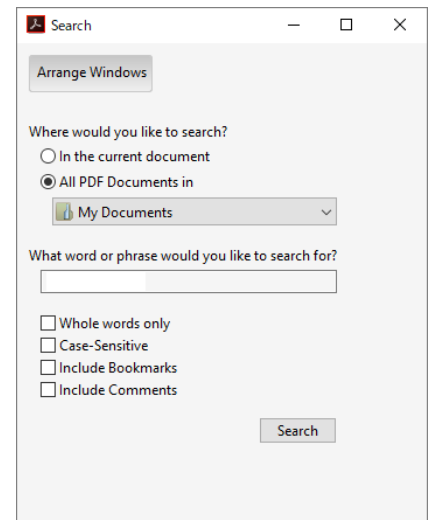

• **Printing out the desired pages.**

Click “Print” in File menu, and then select the paper size and page numbers you want to print.

*The printing setup may differ, depending on the printer. Refer to your printer’s instruction manual for details.

*Select “A4” size to print out the page in the equalized size.

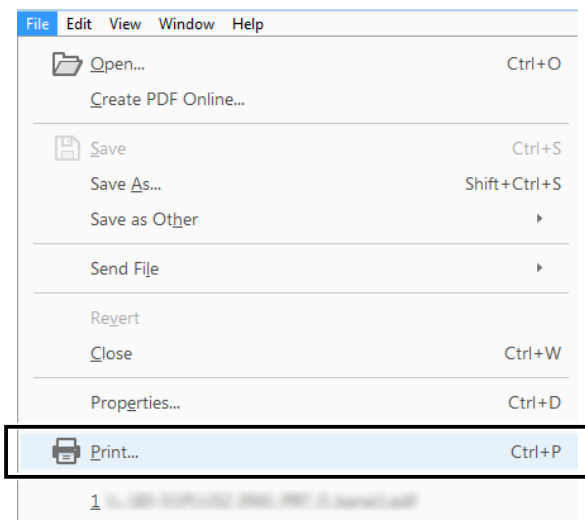

• **Read Out Loud feature.**

The Read Out Loud feature reads aloud the text in this Instruction Manual.

Refer to the Adobe® Acrobat® Reader® Help for the details.

(This feature may not be usable, depending on your PC environment including the operating system.)

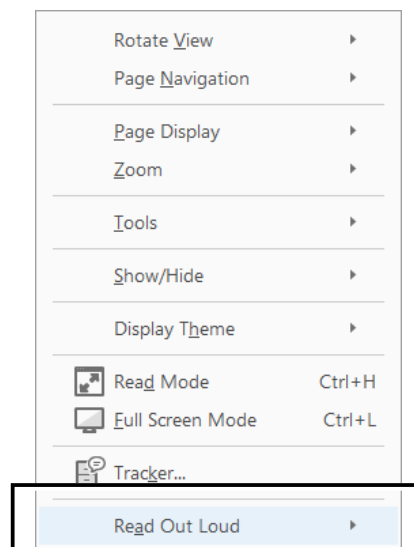

① The screen may differ, depending on the Adobe® Acrobat® Reader® version.

Section 1

ADVANCED OPERATIONS

VOX function	1-2
◇ Turning ON the VOX function.....	1-2
◇ Adjusting the VOX function	1-2
Operating CW (ADVANCED).....	1-3
◇ About the CW Reverse mode.....	1-3
◇ Using the Memory Keyer function (KEYER).....	1-3
◇ Keyer memory edit menu (EDIT).....	1-4
◇ Contest number menu (001 SET)	1-5
◇ Keyer set menu (CW-KEY SET).....	1-6
Operating RTTY (FSK)	1-7
◇ Displaying the RTTY DECODE screen	1-7
◇ RTTY decoding.....	1-7
◇ Twin Peak Filter (TPF).....	1-7
◇ Transmitting an RTTY memory content.....	1-8
◇ Editing an RTTY memory	1-9
◇ Turning ON the RTTY log	1-10
◇ Viewing the RTTY log contents	1-10
◇ RTTY Decode Log set.....	1-11
◇ About the RTTY decode set mode	1-12
Tone squelch operation	1-13
DTCS code squelch operation.....	1-14
FM repeater operation	1-15
◇ Checking the repeater input signal.....	1-15
◇ Setting the repeater tone frequency	1-15
Duplex operation	1-16
Data communication.....	1-16
FSK and AFSK connections	1-17
◇ Using the USB port.....	1-17
◇ Using the ACC socket or the microphone connector.....	1-17

1. ADVANCED OPERATIONS

VOX function

SSB, AM, FM, and DV modes

The Voice-Operated Transmission (VOX) function switches between transmit and receive with your voice. This function enables hands-free operation.

◇ Turning ON the VOX function

- Push **VOX/BK-IN** to turn the VOX function ON or OFF.

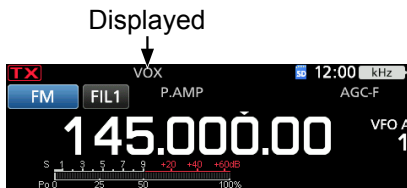

◇ Adjusting the VOX function

Before using the VOX function, adjust the following items.

- VOX GAIN
- ANTI VOX
- DELAY
- VOICE DELAY

1. Hold down **VOX/BK-IN** for 1 second.
2. Touch the item to adjust.

(Example: ANTI VOX)

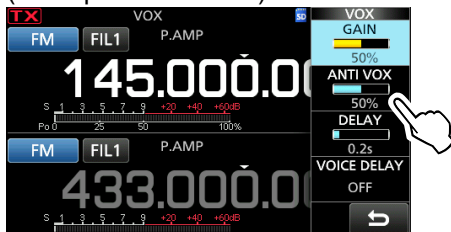

3. Rotate **ⓂMULTI** to adjust the item.
① Touching VOICE DELAY selects “SHORT,” “MID,” “LONG,” or “OFF”.
4. To close the VOX menu, push **ⓂMULTI**.

VOX GAIN (Default: 50%)

Adjusts the transmit/receive switching threshold level to between 0% and 100% for VOX operation. Higher values make the VOX function more sensitive to your voice.

ANTI VOX (Default: 50%)

Adjusts the ANTI VOX level to between 0% and 100% to prevent unwanted VOX activation from the speaker or other sounds. Higher values make the VOX function less sensitive.

DELAY (Default: 0.2s)

Adjusts the DELAY to between 0 and 2.0 seconds, for a convenient interval for normal pauses in speech before returning to receive.

VOICE DELAY (Default: OFF)

Sets the VOICE DELAY to prevent picking up your voice when switching to transmit.

- Select “SHORT,” “MID,” “LONG,” or OFF.

Operating CW (ADVANCED)

◇ About the CW Reverse mode

The CW-R (CW Reverse) mode reverses the receive Beat Frequency Oscillator (BFO) to receive CW signals.

Use this when interfering signals are near the desired signal and you want to use the CW-R to reduce interference.

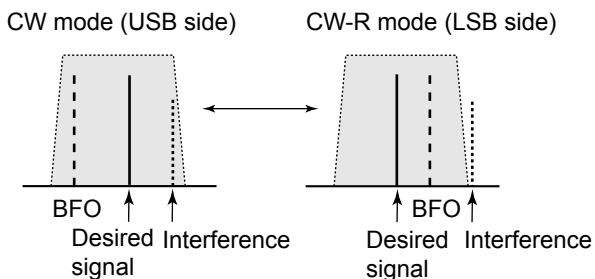

TIP: Reversing the carrier point The carrier point of the CW mode is USB by default. You can change it to LSB on the FUNCTION screen.

MENU » **SET > Function > CW Normal Side**

① When this setting is set to “LSB,” the CW and CW-R modes are reversed.

◇ Using the Memory Keyer function (KEYER)

You can send preset characters using the Memory Keyer function.

Sending

1. Display the KEYER screen.

MENU » **KEYER**

- ① The [KEYER] key is displayed only in the CW mode.
2. Push **TRANSMIT**.
 - The TX/RX indicator lights red.
 - ① If you want to automatically switch between transmit and receive, turn ON the Break-in function (See BASIC MANUAL).
3. Touch a Memory Keyer key between [M1] and [M8]. (Example: [M1])

Sending contents



- The touched Memory Keyer is sent.
4. To repeatedly send the Memory contents, touch the Memory Keyer key for 1 second. Repeat icon



- ① The Memory contents will be repeatedly sent, according to the setting in “Keyer Repeat Time.”
- ① To stop sending, touch the Memory Keyer key again.

Key	Action	
M1 ~ M8	Touch	Sends the Memory keyer contents.
	Touch for 1 second	 is displayed and repeatedly sends the Memory keyer contents. ① You can change the repeat interval setting in “Keyer Repeat Time” in the CW-KEY SET menu. (p. 1-6)
-1 001	Reduces the contest number counter by 1 (001). ① You can change or reset the number in “Present Number” in the KEYER 001 menu. (p. 1-5)	
EDIT/SET	Touch to display the EDIT/SET screen.	

1. ADVANCED OPERATIONS

Operating CW (ADVANCED)

◇ Using the Memory Keyer function (KEYER)

Count up trigger

The count up trigger enables the serial number to be automatically increased after each complete serial number exchange is sent. (Default: M2)

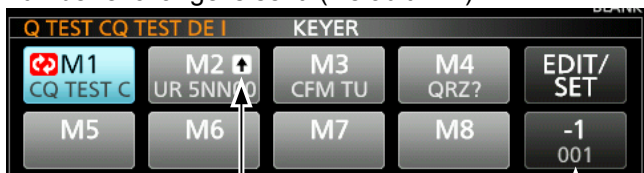

Count up trigger icon

Present number counter

- ① is displayed on the Memory keyer set to the count up trigger.
- ② You can change the count up trigger setting in the KEYER 001 menu. (p. 1-5)

Preset Memory keyer contents

Memory keyer	Contents
M1	CQ TEST CQ TEST DE ICOM ICOM TEST
M2	UR 5NN <i>001</i> BK
M3	CFM TU
M4	QRZ?

- ③ "001" is the CW contest number.
If you want to set the Count up trigger to different keyer, delete "*" (asterisk) from the Memory keyer M2. See "Keyer memory edit menu (EDIT)" to the right.

Using an external keypad

You can send the preset contents without opening the KEYER screen. See BASIC MANUAL.

◇ Keyer memory edit menu (EDIT)

Edit the Memory keyer contents in the EDIT menu.
① You can use up to a total of 8 Memory keyers (M1 to M8), and you can enter up to 70 characters in each memory.

Editing

(Example: Entering "QSL TU DE JA3YUA TEST" to M3)

1. Display the KEYER MEMORY screen in the CW mode.

MENU » **KEYER > EDIT/SET > EDIT**

2. Touch "CFM TU" for 1 second.

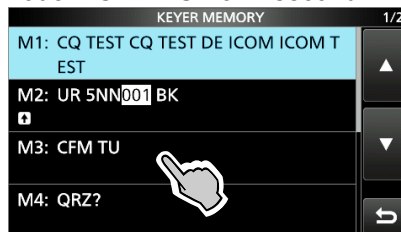

3. Touch "Edit."

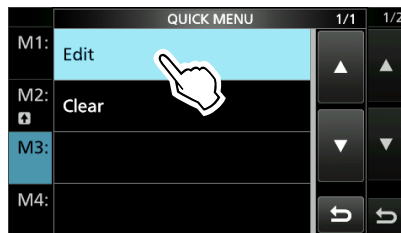

4. Touch [CLR] on the Keyer Memory keyboard until the preset contents are cleared.



1. ADVANCED OPERATIONS

Operating CW (ADVANCED)

◇ Keyer memory edit menu (EDIT)

5. Enter “QSL TU DE JA3YUA TEST,” and then touch [ENT] to save.

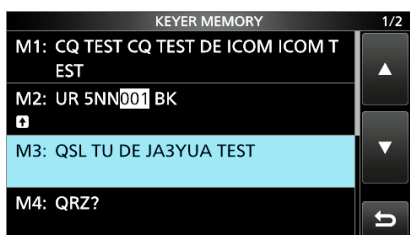
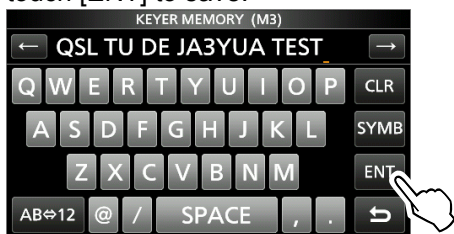

6. To close the KEYER MEMORY screen, push [EXIT].

Selectable characters	
Alphabets	ABCDEFGHIJKLMNOPQRSTUVWXYZ
Symbols	/ ? ^ . , @ *
Numbers	1234567890

About the symbols

- Enter “^” to send a string of characters with no intercharacter space. Put “^” before a text string such as ^AR, and the string “ar” is sent with no space.
- Enter “*” (asterisk) to insert the CW contest number. The number automatically advances by 1. You can use this for only 1 Memory keyer at a time. “*” is used in Memory keyer M2 by default.

◇ Contest number menu (001 SET)

You can set the number style, count up trigger and preset number.

Setting

1. Display the KEYER 001 menu in the CW mode.
[MENU] » [KEYER > EDIT/SET > 001 SET]
2. Select the setting item. (Example: Number Style)

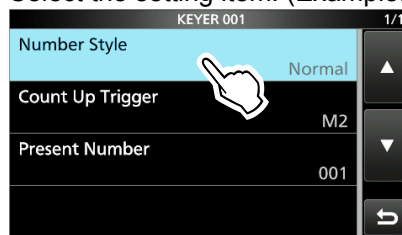

3. Select the setting option.

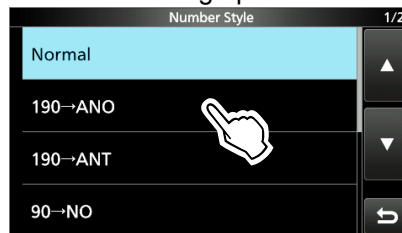

- Returns to the KEYER 001 menu.

4. To close the “KEYER 001” screen, push [EXIT].

Number Style (Default: Normal)

Set the numbering system used for contest (serial) numbers— normal or short morse numbers. Select Normal, 190→ANO, 190→ANT, 90→NO or 90→NT.

Count Up Trigger (Default: M2)

Select which of the 8 memories will contain the contest serial number exchange. Select between M1 ~ M8.

Present Number (Default: 001)

Set the current number for the Count Up Trigger. Set to between 001 ~ 9999.

TIP: How to reset to the default setting

Touching the item or its option for 1 second displays the Quick menu, and then touch “Default” to reset to the default setting.

1. ADVANCED OPERATIONS

Operating CW (ADVANCED)

◇ Keyer set menu (CW-KEY SET)

In this menu, you can set the memory keyer repeat time, dash weight, paddle specifications, key type, and so on.

Setting example

1. Display the CW-KEY SET menu in the CW mode.

MENU » **KEYER > EDIT/SET > CW-KEY SET**

2. Select a setting item. (Example: Side Tone Level)

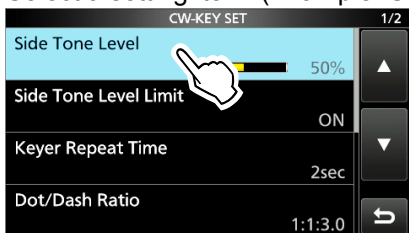

3. Adjust the Side Tone Level. (Example: 80%)

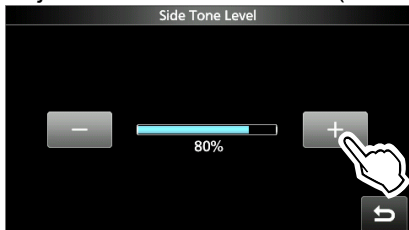

4. To close the CW-KEY SET screen, push **EXIT** several times.

Side Tone Level (Default: 50%)

Adjust the CW side tone output level.
Adjust to between 0 ~ 100%.

Side Tone Level Limit (Default: ON)

Turn the CW side tone level limit ON or OFF. This disables the CW side tone when you rotate **AF** (inner) above the side tone level.

Keyer Repeat time (Default: 2sec)

Set the time between Memory keyer transmissions.
Set to between 1 ~ 60 seconds.

- ① After transmitting a Memory keyer, the transmission is repeated after the set time period.
- ① is displayed even between transmissions.

Dot/Dash Ratio (Default: 1:1:3.0)

Set the dot/dash ratio.

- Set to between 1:1:2.8 ~ 1:1:4.5 in 0.1 steps.

Keying weight example: Morse code "K"

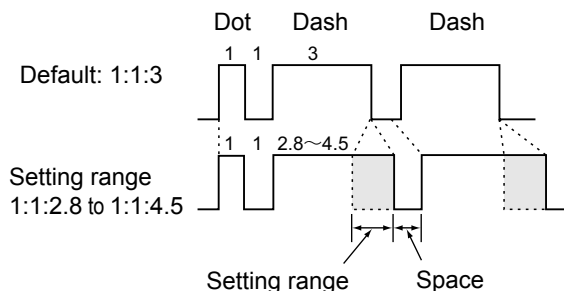

Rise Time (Default: 4ms)

Set the rise time of the transmitted CW envelope.

- Set to 2, 4, 6 or 8 milliseconds.

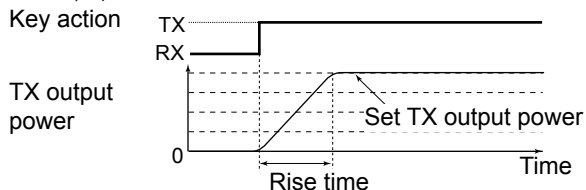

Paddle Polarity (Default: Normal)

Set the paddle dot-dash polarity to Normal or Reverse.

- Normal: Right = dash, Left = dot
- Reverse: Right = dot, Left = dash

Key Type (Default: Paddle)

Set the key type for the [KEY] connector on the rear panel.

- Set to Straight, Bug or Paddle.
- ① When using an external Elec-keyer, select "Straight."

MIC Up/Down Keyer (Default: OFF)

Set the microphone [UP]/[DN] keys to use as a CW key.

- ON: Use the [UP]/[DN] keys as a CW key.
- OFF: Do not use the [UP]/[DN] keys as a CW key.
- ① The [UP]/[DN] keys do not work as a "squeeze key."
- ① When "ON" is selected, you cannot change the frequency and the Memory channels using the [UP]/[DN] keys.

TIP: How to reset to the default setting

Touching the item or its option for 1 second displays the Quick menu, and then touch "Default" to reset to the default setting.

1. ADVANCED OPERATIONS

Operating RTTY (FSK)

The IC-9700 has a built-in RTTY decoder and encoder. Using contents set in the RTTY TX memory, you can do basic RTTY operations without using an external device or software.

◇ Displaying the RTTY DECODE screen

With the built-in demodulator and decoder, received RTTY signals are displayed on the RTTY DECODE screen.

MENU » **DECODE**

RTTY DECODE screen

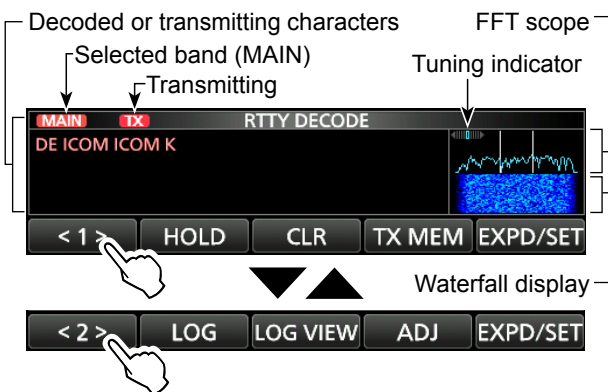

Key	Action	
<1> <2>	Selects the Function menus.	
HOLD	Turns the Hold function ON or OFF. • “HOLD” is displayed, and the RTTY DECODE screen stops.	
CLR	Clears the displayed characters. • While the Hold function is ON, this clears the characters and cancels the Hold function.	
TX MEM	Opens the RTTY MEMORY screen. • Sending the RTTY MEMORY RT1 ~ RT8.	
LOG	Displays the RTTY DECODE LOG screen. • Starts/Stops logging, selects the file type or the time stamp.	
LOG VIEW	Displays the RTTY DECODE LOG VIEW screen. • You can check the saved RTTY log files.	
ADJ	Opens the THRESHOLD screen. • You can adjust the threshold level.	
EXPD/ SET	Touch	Selects the Expanded or Normal screen.
	Touch 1 second	Displays the RTTY DECODE SET screen.

◇ RTTY decoding

Rotate **(MAIN DIAL)** to tune a signal.

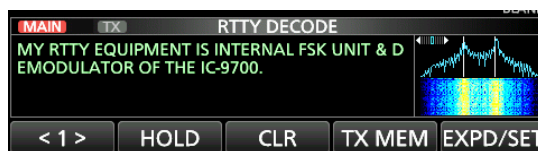

- Aim for a symmetrical wave form, and be sure the peak points align with the mark (2125 Hz) and shift (170 Hz) frequency lines in the FFT scope.
- Tune to where both “◀” and “▶” are displayed in the tuning indicator.
- The S-meter displays the received signal strength, when a signal is received.
- If you are receiving an RTTY signal but cannot decode correctly, try in the RTTY-R (reverse) mode.

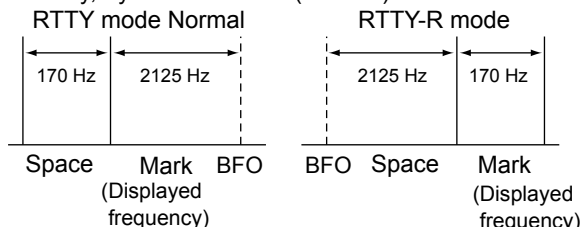

TIP: If you cannot receive, change the settings for “RTTY Mark Frequency” and “RTTY Shift Width.”

MENU » **SET > Function > RTTY Mark Frequency**

MENU » **SET > Function > RTTY Shift Width**

◇ Twin Peak Filter (TPF)

The Twin Peak Filter (TPF) changes the audio frequency response by boosting the mark and space frequencies for better reception of RTTY signals, or for decoding the AF output signal on a PC.

1. Push **(MULTI)** to display the Multi-function menu.
2. Touch [TPF].
① Touching [TPF] turns the Twin Peak Filter function ON or OFF.
3. Push **(MULTI)** to close the Multi-function menu.

NOTE: When you are using the Twin Peak Filter, the received audio output may increase. This is not a malfunction.

1. ADVANCED OPERATIONS

Operating RTTY (FSK)

◇ Transmitting an RTTY memory content

You can transmit the preset characters on the RTTY MEMORY screen.

① You can edit the contents by touching [EDIT] on the RTTY MEMORY screen.

1. Display the RTTY DECODE screen in the RTTY mode.

MENU » **DECODE**

2. Touch [TX MEM].

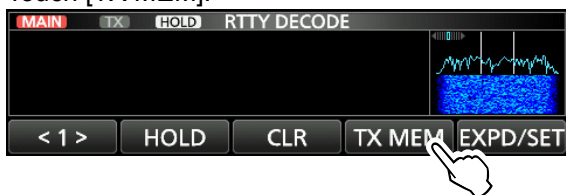

3. Touch an RTTY memory between [RT1] and [RT8] to transmit. (Example: RT1)



Transmitting

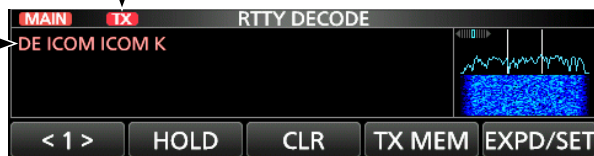

Transmitting contents are displayed.

- The TX status indicator lights red and the Po meter swings.
- ① To cancel the transmission and to return to the RTTY DECODE screen, push **EXIT**.
 - ① After transmitting, automatically returns to receive.

Memory	Preset characters by default
RT1	↓ DE ICOM ICOM K ↓
RT2	↓ DE ICOM ICOM ICOM K ↓
RT3	↓ QSL UR 599-599 BK ↓
RT4	↓ QSL DE ICOM ICOM UR 599-599 BK ↓
RT5	↓ 73 GL SK ↓
RT6	↓ CQ CQ CQ DE ICOM ICOM ICOM K ↓
RT7	↓ MY TRANSCEIVER IS IC-9700 & ANTENNA IS A 2X13-ELEMENT YAGI. ↓
RT8	↓ MY RTTY EQUIPMENT IS INTERNAL FSK UNIT & DEMODULATOR OF THE IC-9700. ↓

When an external keypad is connected:

You can transmit the preset contents in the RTTY memory (RT1 ~ RT4) from an external device by setting the “External Keypad,” and then connecting an external keypad to [MIC] on the IC-9700.

MENU » **SET > Connectors > External Keypad**

1. ADVANCED OPERATIONS

Operating RTTY (FSK)

◇ Editing an RTTY memory

You can edit the characters in the RTTY memories. You can save and transmit 8 RTTY memories (RT1 ~ RT8) for often-used RTTY messages. Each RTTY memory can contain up to 70 characters.

1. Display the RTTY MEMORY editing screen.

MENU » **DECODE > TX MEM > EDIT**

2. Touch the memory for 1 second to edit the content. (Example: RT2)



3. Touch "Edit."

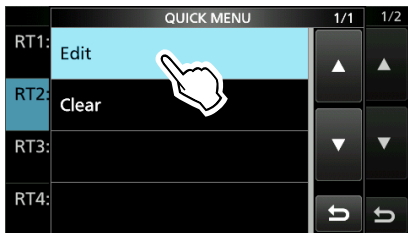

4. To clear a character, touch [←] or [→] to move the cursor, then touch [CLR].

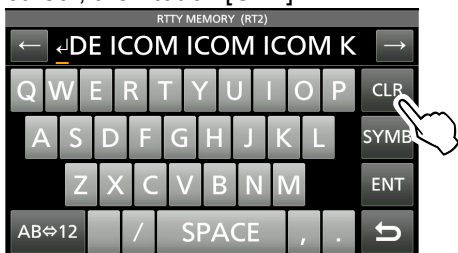

5. Enter the new characters, and then touch [ENT] to save.

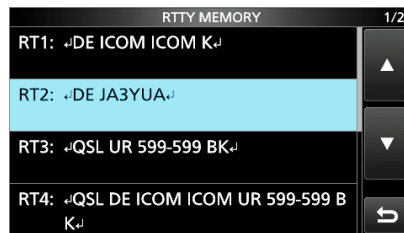

6. To exit the RTTY DECODE screen, push **EXIT** several times.

1. ADVANCED OPERATIONS

Operating RTTY (FSK)

◇ Turning ON the RTTY log

Turn ON the RTTY log to save your TX and RX RTTY operating record onto an SD card.

- ① You can select the data format type in the “Log Set” item on the RTTY DECODE LOG screen.
- ② The log is saved even while “HOLD” is ON.

1. Display the RTTY DECODE LOG screen.

MENU » **DECODE > <1> > LOG**

2. Touch “Decode Log.”

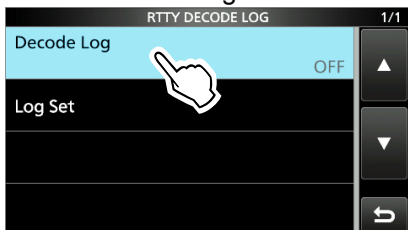

3. Select “ON.”

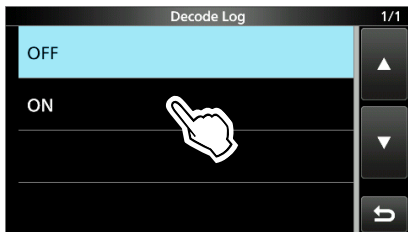

4. Push **EXIT**.
 - “•” is displayed on the RTTY DECODE screen while the RTTY log is ON.
5. To turn OFF the RTTY log, select “OFF” in step 3.

TIP: How to reset to the default setting

Touching the item or its option for 1 second displays the Quick menu, and then touch “Default” to reset to the default setting.

◇ Viewing the RTTY log contents

You can view the saved RTTY log contents.

1. Insert the SD card that the RTTY log is saved.
2. Display the RTTY DECODE LOG VIEW screen.

MENU » **DECODE > <1> > LOG VIEW**

3. Touch the log file to view.

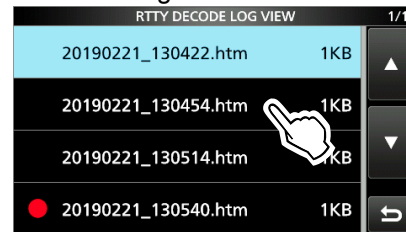

- The file with “•” is logging. You cannot view this log’s contents.

4. To exit the RTTY DECODE LOG VIEW screen, push **EXIT** several times.

Checking the file information and deleting a file

1. Touch the log file that you want to view or delete for 1 second.
2. Select an item from “File Information,” “Delete” and “Delete All.”
 - File Information: Displays the file name, size and logged date.
 - Delete: Deletes the selected log file.
 - Delete All: Deletes all log files.

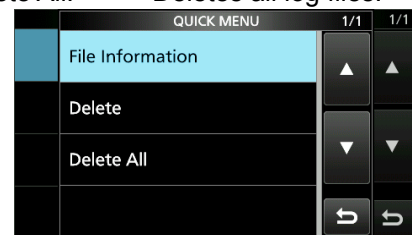

1. ADVANCED OPERATIONS

Operating RTTY (FSK)

◇ RTTY Decode Log set

This mode is for the log file type, time stamp setting, and other RTTY settings.

1. Display the RTTY DECODE LOG SET screen.

MENU » **DECODE > <1> > LOG SET**

2. Select an item to set. (Example: File Type)

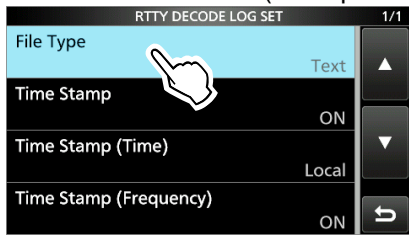

3. Select a setting option. (Example: HTML)

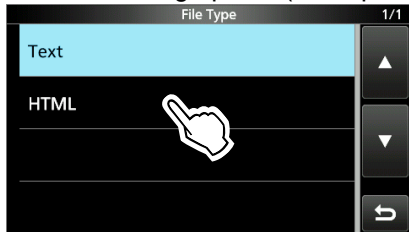

4. To exit the RTTY DECODE LOG SET screen, push **EXIT** several times.

TIP: How to reset to the default setting

Touching the item or its option for 1 second displays the Quick menu, and then touch "Default" to reset to the default setting.

File Type (Default: Text)

Select the file type to save a log onto an SD card to Text or HTML.

① You cannot change the file type while logging.

Time Stamp (Default: ON)

Select whether or not to add the time stamp (date, transmission time and reception time) in the log.

- ON: Adds the time stamp in the log.
- OFF: Does not add the time stamp.

Time Stamp (Time) (Default: Local)

Select whether to save the log with the local time or with the UTC time.

Time Stamp (Frequency) (Default: ON)

Select whether or not to add the frequency in the log.

- ON: Adds the frequency.
- OFF: Does not add the frequency.

1. ADVANCED OPERATIONS

Operating RTTY (FSK)

◇ About the RTTY decode set mode

This set mode is for the FFT scope setting, USOS function, and so on.

1. Open the RTTY DECODE screen in the RTTY mode.

MENU » **DECODE > <1> > LOG SET**

2. Touch [EXPD/SET] for 1 second.
 - Opens the RTTY DECODE SET screen.



3. Select an item to set. (Example: FFT Scope Averaging)

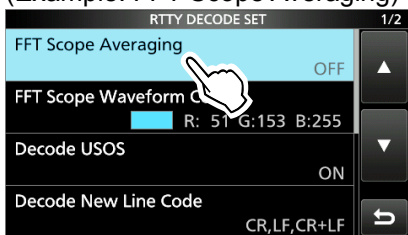

4. Select the desired option or setting. (Example: 2)

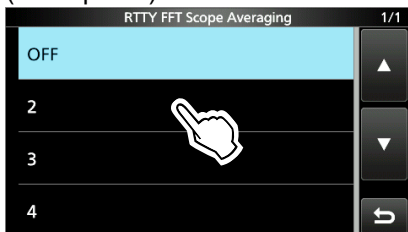

5. To close the RTTY DECODE SET screen, push **EXIT** several times.

TIP: How to reset to the default setting
Touching the item or its option for 1 second displays the Quick menu, and then touch “Default” to reset to the default setting.

FFT Scope Averaging (Default: OFF)

Set the FFT scope waveform averaging function to between 2 and 4 or to OFF.

- ① Use the default or smaller FFT scope waveform number for tuning.

FFT Scope Waveform Color (Default: R: 51, G: 153, B: 255)

Set the color of the FFT scope waveform.

- ① Touch and select the R (Red), G (Green) or B (Blue) scale, and then rotate **(MULTI)** or **(MAIN DIAL)** to adjust the ratio to between 0 and 255.
- ① The color is displayed in the box above the RGB scale.

Decode USOS (Default: ON)

Turn the letter code decoding capability ON or OFF after receiving a “space.”

USOS stands for UnShift On Space function.

- ON: Decodes as a letter code.
- OFF: Decodes as a character code.

Decode New Line Code (Default: CR, LF, CR+LF)

Select the internal RTTY decoder new line code.

- ① CR stands for Carriage Return, and LF stands for Line Feed.
- CR,LF,CR+LF: Makes a new line with any codes.
- CR+LF: Makes a new line with only CR+LF code.

TX USOS (Default: ON)

Explicitly inserts the FIGS character, even though it is not required by the receiving station.

- ON: Inserts FIGS.
- OFF: Does not insert FIGS.

Displayed Characters during Tx (Satellite) (Default: TX)

Select the character to display during the Satellite operation.

- RX: Displays decoded characters.
- TX: Displays transmitted characters.

Font Color (Receive) (Default: R: 128, G: 255, B: 128)

Font Color (Transmit) (Default: R: 255, G: 106, B: 106)

Set the text font color for received or transmit characters.

- ① Touch and select the R (Red), G (Green) or B (Blue) scale, and then rotate **(MULTI)** or **(MAIN DIAL)** to adjust the ratio to between 0 and 255.
- ① The color is displayed in the box above the RGB scale.

1. ADVANCED OPERATIONS

Tone squelch operation

FM mode

The Tone squelch opens only when you receive a signal that includes a matching subaudible tone in the FM mode. You can silently wait for calls from other stations using the same tone. When you transmit, the tone frequency is superimposed on your own signal.

1. Push **FUNCTION**.
 - Opens the FUNCTION screen.
2. Touch **[TONE]**.



3. Touch the Tone squelch mode.

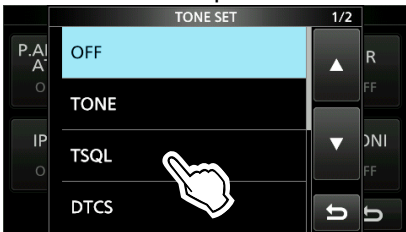

4. Touch **[TONE]** for 1 second.

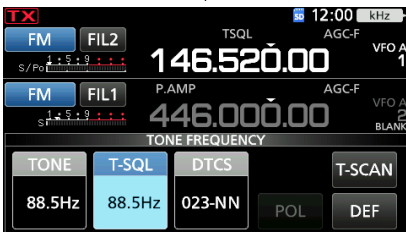

5. Rotate **(MAIN DIAL)** to set the tone frequency.

• Selectable tone frequencies

67.0	88.5	114.8	151.4	177.3	203.5	250.3
69.3	91.5	118.8	156.7	179.9	206.5	254.1
71.9	94.8	123.0	159.8	183.5	210.7	
74.4	97.4	127.3	162.2	186.2	218.1	
77.0	100.0	131.8	165.5	189.9	225.7	
79.7	103.5	136.5	167.9	192.8	229.1	
82.5	107.2	141.3	171.3	196.6	233.6	
85.4	110.9	146.2	173.8	199.5	241.8	

About the tone squelch types indication

TSQL: Tone Squelch function

DTCS(T)/TSQL(R) (“D” in “D-TSQL” blinks):

DTCS code in TX, Tone squelch in RX

TONE(T)/TSQL(R) (“T” in “T-TSQL” blinks):

Repeater tone in TX, Tone squelch in RX

Checking another station’s tone frequency

You can check another station’s tone frequency by tone scanning while the station is transmitting.

1. Touch **[T-SCAN]**.

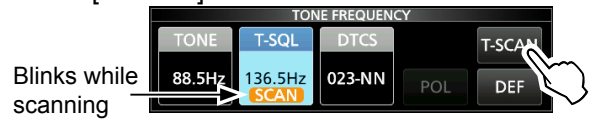

- The scan starts, and then stops when the matching tone frequency as another station is received.
2. To close the TONE FREQUENCY screen, push **EXIT**.

1. ADVANCED OPERATIONS

DTCS code squelch operation

FM mode

The Tone squelch opens only when you receive a signal that includes a matching DTCS code in the FM mode. You can silently wait for calls from other stations using the same tone.

When you transmit, the DTCS code is superimposed on your own signal.

1. Push **FUNCTION**.
 - Opens the FUNCTION screen.
2. Touch **[TONE]**.



3. Touch to select the DTCS code type.

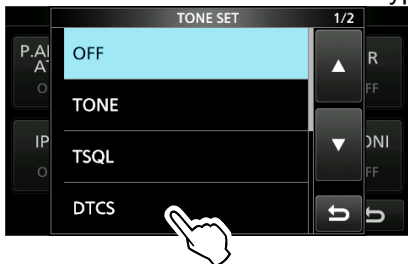

4. Touch **[TONE]** for 1 second.
 - Opens the TONE FREQUENCY screen.

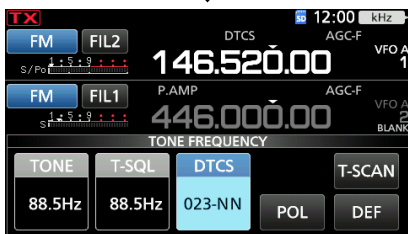

5. Rotate **(MAIN DIAL)** to set a DTCS code.

About the DTCS code types indication

DTCS: DTCS Code function

DTCS(T) (“DTCS” blinks):

DTCS code in TX, Tone off in RX

TONE(T)/DTCS(R) (“T” in “T-DTCS” blinks):

Repeater tone in TX, DTCS code squelch in RX

DTCS(T)/TSQL(R) (“D” in “D-TSQL” blinks):

DTCS code in TX, Tone squelch in RX

Checking another station’s DTCS code

You can check another station’s tone code by tone scanning while the station is transmitting.

1. Touch **[T-SCAN]**.

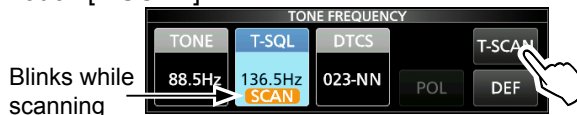

Blinks while scanning

- The scan starts, and then stops when the matching DTCS code as another station is received.

2. To close the TONE FREQUENCY screen, push **EXIT**.

• Selectable DTCS codes

023	054	125	165	245	274	356	445	506	627	732
025	065	131	172	246	306	364	446	516	631	734
026	071	132	174	251	311	365	452	523	632	743
031	072	134	205	252	315	371	454	526	654	754
032	073	143	212	255	325	411	455	532	662	
036	074	145	223	261	331	412	462	546	664	
043	114	152	225	263	332	413	464	565	703	
047	115	155	226	265	343	423	465	606	712	
051	116	156	243	266	346	431	466	612	723	
053	122	162	244	271	351	432	503	624	731	

1. ADVANCED OPERATIONS

FM repeater operation

A repeater receives your radio's signals and simultaneously retransmits them on a different frequency to provide a greater communication range. When using a repeater, the transmit frequency shifts from the receive frequency by an offset amount. You can access a repeater using the split function.

1. Select the VFO mode.
2. Set the operating mode to "FM."
3. Set the receive frequency (Repeater output frequency).

① For only the U.S.A. and Korean versions:

When the Auto Repeater function is turned ON, steps 4 and 5 are not necessary.

The Auto Repeater function automatically sets the repeater settings (duplex ON/OFF, duplex direction, tone encoder ON/OFF).

① You can turn OFF the function and manually set the repeater settings.

MENU » **SET > Function > Auto Repeater**

4. Set the Duplex direction and frequency offset.
 - ① See page 1-16 for setting details.
5. Set the repeater tone.
 - ① See "Setting the repeater tone frequency" to the right.
6. Communicate in the normal way.
 - Subaudible tones are superimposed on your transmit signal.

◇ Checking the repeater input signal

You can check whether you can directly receive another station's transmit signal or not, by listening to the repeater input frequency.

① While listening, the TX/RX indicator lights green, and then the Noise Reduction and Notch Filter settings are canceled.

While receiving, hold down **XFC** to listen the repeater input frequency.

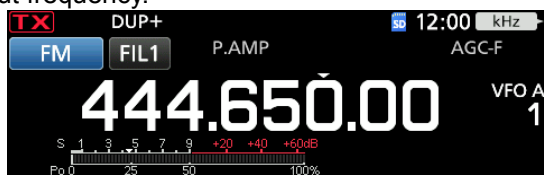

While holding down **XFC**, Release **XFC**.
Frequency offset

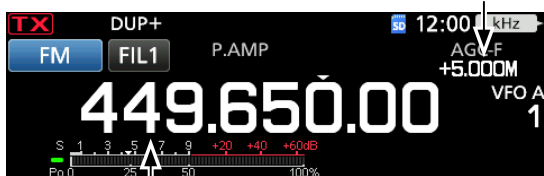

Another station's transmit frequency

◇ Setting the repeater tone frequency

Some repeaters require a subaudible tone to be accessed. Subaudible tones are superimposed on your signal, and must be set in advance.

Do the following steps to set the tone frequency.

1. Push **FUNCTION**.
2. Touch [TONE] for 1 second.
 - Opens the TONE FREQUENCY screen.

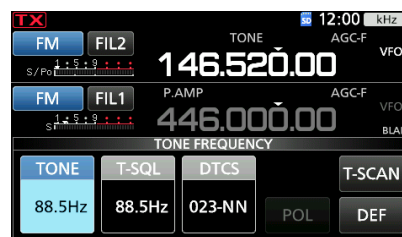

3. Rotate **MAIN DIAL** to select the desired subaudible tone frequency.

• **Selectable tone frequencies**

67.0	88.5	114.8	151.4	177.3	203.5	250.3
69.3	91.5	118.8	156.7	179.9	206.5	254.1
71.9	94.8	123.0	159.8	183.5	210.7	
74.4	97.4	127.3	162.2	186.2	218.1	
77.0	100.0	131.8	165.5	189.9	225.7	
79.7	103.5	136.5	167.9	192.8	229.1	
82.5	107.2	141.3	171.3	196.6	233.6	
85.4	110.9	146.2	173.8	199.5	241.8	

Checking the repeater tone frequency

You can check the tone frequency by receiving the repeater's input frequency using the tone scan. To receive the input signals, the transceiver detects the subaudible tone frequency using the tone scan function.

1. Touch [T-SCAN].

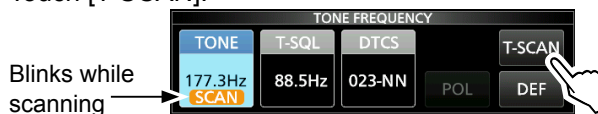

Blinks while scanning

- The scan starts, and then stops when the matching tone frequency as the repeater is received.
2. To close the TONE FREQUENCY screen, push **EXIT**.

1. ADVANCED OPERATIONS

Duplex operation

The Duplex operation shifts the transmit frequency up or down from the receive frequency by an offset amount.

- OFF: For simplex operation (the receive and transmit frequencies are the same).
- DUP-: The transmit frequency shifts down from the receive frequency by the offset amount.
- DUP+: The transmit frequency shifts up from the receive frequency by the offset amount.

1. Push **FUNCTION**.
2. Touch [②].
3. Touch [DUP].



- Each touch selects “DUP-,” “DUP+,” or “OFF.”

4. Touch [DUP] for 1 second.



5. Enter the frequency offset, and then touch [ENT].

NOTE: When the Auto Repeater function is ON, and the operating frequency is set out of the Repeater output frequency range, the duplex mode is automatically canceled.

MENU » **SET > Function > Auto Repeater**

Data communication

SSB-DATA, AM-DATA, and FM-DATA modes

You can operate the data mode using AFSK (Audio Frequency Shift Keying).

① When operating PSK31, SSTV, JT65B, or FT8 with a PC application software, refer to the software's instruction manual.

1. Connect a PC or other device to the transceiver.
① See the next page for the connection.
2. Set the operating frequency and mode.
3. Refer to the application software for communication details.
① When operating in the SSB data mode, adjust the device's output level within the ALC zone.

TIP: The carrier point is displayed when operating AFSK in the SSB data mode.

See the illustration below for a tone-pair example.

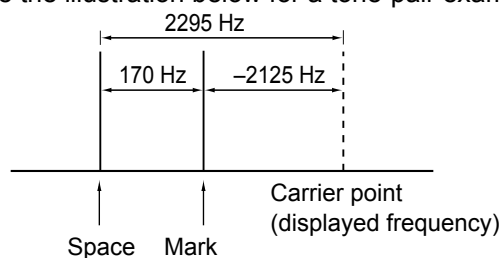

1. ADVANCED OPERATIONS

FSK and AFSK connections

You can use a PC and an application software to operate SSTV, RTTY, AFSK, PSK31, JT65, or FT8 using a USB cable. However, if you want to operate RTTY or other digital modes, you can use the ACC socket on the rear panel through an interface unit. Refer to the software application's instruction manual for setup details.

① The transceiver has a mode key for RTTY.

① Icom does not guarantee performance of the application software, PC, network device or network settings.

Using the USB port

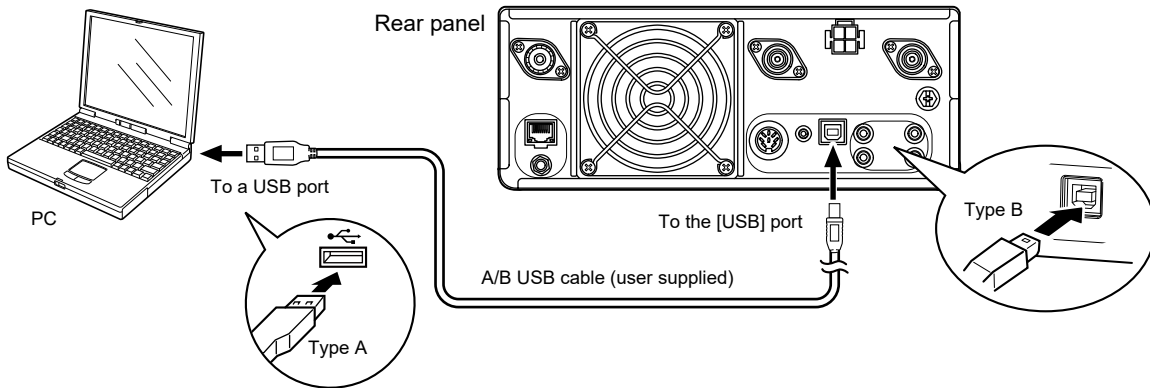

TIP:

- If you set the "USB (B) Function" item to "RTTY Decode," the decoded RTTY signals are output from the USB port.

MENU » **SET > Connectors > USB (B)/DATA Function > USB (B) Function**

- You can download the USB driver and the installation guide from the Icom website.
https://www.icomjapan.com/support/firmware_driver/

Using the ACC socket or the microphone connector

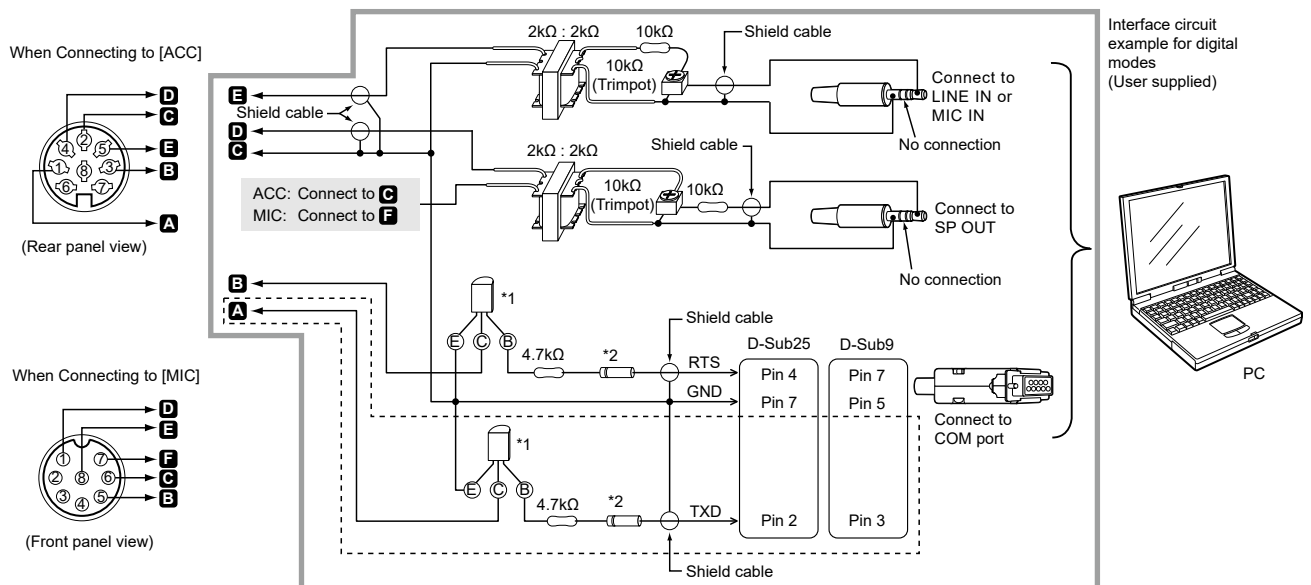

NOTE: You can operate ONLY AFSK RTTY when you connect the circuit to the microphone connector.

*1 NPN transistor (2SC1815) *2 Switching diode (1S1588)

{ } The sections shown in short dashes are required only when Baudot RTTY is used in the FSK (RTTY) mode. (Not required for other digital modes such as SSTV or PSK)

Section 2

SCOPE OPERATION (ADVANCED)

Spectrum Scope screen	2-2
◇ Adjusting the sweep speed	2-2
◇ Adjusting the Reference level.....	2-2
SCOPE SET screen	2-3
Audio scope screen.....	2-5
◇ AUDIO SCOPE SET screen.....	2-5

2. SCOPE OPERATION (ADVANCED)

Spectrum Scope screen

◇ Adjusting the sweep speed

Select the sweep speed to change the FFT scope refresh speed and the waterfall speed.

① To change only the waterfall speed, select “Slow,” “Mid,” or “Fast” in the Waterfall Speed.

1. Display the SPECTRUM SCOPE screen.
MENU » **SCOPE**
2. Touch [**< 1 >**] to display MENU 2.
3. Touch [**SPEED**] several times until the desired sweep speed is selected.
 - Selectable speeds: FAST, MID, or SLOW
 - ① “▶▶▶,” “▶▶,” or “▶” indicates FAST, MID, or SLOW.
 - ① A popup window is displayed in the center of the SPECTRUM SCOPE screen and displays the selected sweep speed for 1 second.

“▶▶▶,” “▶▶,” or “▶” is displayed.

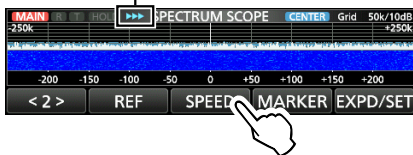

◇ Adjusting the Reference level

When monitoring a weak signal that is buried in the noise floor, or monitoring a strong signal but some stronger signals are nearby, adjusting the Reference level of the screen helps you to see these signals.

- Even if this setting is changed, it does not affect the input signal level.
 - When you adjust the Reference level, the signal strength for the waterfall also appears to change.
- ① Each band memorizes the setting.

1. Display the SPECTRUM SCOPE screen.
MENU » **SCOPE**
2. Touch [**< 1 >**] to display MENU 2.
3. Touch [**REF**].

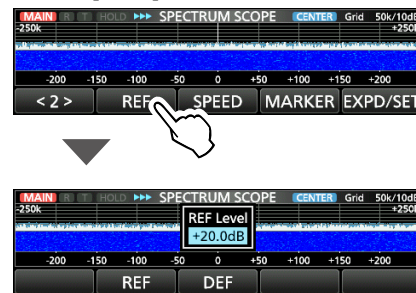

4. Rotate **MAIN DIAL** to adjust the level.
 - Adjustable range: $-20.0\text{ dB} \sim +20.0\text{ dB}$
 - ① You can reset to $\pm 0.0\text{ dB}$ by touching [**DEF**] for 1 second.
5. To close the REF Level window, touch [**REF**].

The difference in the spectrum

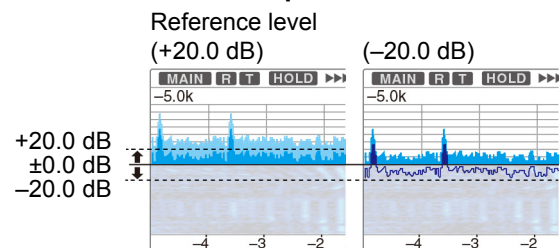

- ① If you adjust this setting to a positive level, all signal levels appear stronger.
 Or, if you adjust to a negative level, all signal levels appear weaker.

2. SCOPE OPERATION (ADVANCED)

SCOPE SET screen

This screen is used to set the waveform color, Scope range for the Fixed mode, and so on.

1. Display the SPECTRUM SCOPE screen.

MENU » **SCOPE**

2. Touch [EXPD/SET] for 1 second.

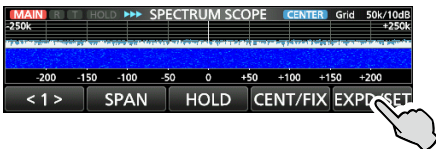

3. Touch the item to set.
(Example: Max Hold)

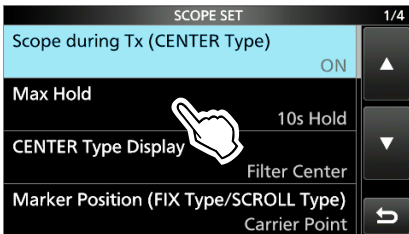

4. Touch the option to set.

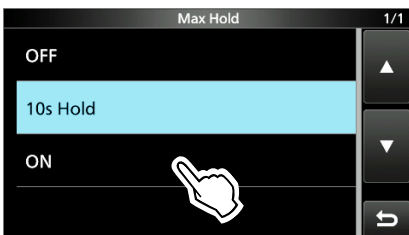

① See below for details on the setting items and their options.

5. To close the SCOPE SET screen, push **EXIT**.

TIP: You can set each item to its default by touching the item for 1 second, and then touching “Default” on the QUICK MENU screen.

Scope during Tx (CENTER Type) (Default: ON)

Turns the TX signal display ON or OFF.

Max Hold (Default: 10s Hold)

Selects the peak level holding function.

- OFF: Turns OFF the peak level holding function.
- 10s Hold: Holds the peak spectrum for 10 seconds.
- ON: Continuously holds the peak spectrum.

CENTER Type Display (Default: Filter Center)

Selects the center frequency of the SPECTRUM SCOPE screen. (Only in the Center mode)

- Filter Center: Displays the selected filter’s center frequency in the center of the SPECTRUM SCOPE screen.
- Carrier Point Center: Displays the carrier point frequency of the selected operating mode in the center of the SPECTRUM SCOPE screen.
- Carrier Point Center (Abs. Freq.): In addition to the carrier point center setting above, the actual frequency is displayed at the bottom of the scope.

① Abs. Freq. : Absolute Frequency

Marker Position (FIX Type/SCROLL Type)

(Default: Carrier Point)

Selects the marker position on the SPECTRUM SCOPE screen. (Only in the Fixed or Scroll mode)

- Filter Center: Displays the Marker on the selected filter’s center frequency.
- Carrier Point: Displays the Marker on the carrier point frequency of the selected operating mode.

VBW (Default: Narrow)

Selects the Video Band Width (VBW).

- Narrow: Sets the VBW to narrow.
- Wide: Sets the VBW to wide.

Averaging (Default: OFF)

Sets the FFT scope waveform averaging function to between 2 and 4, or OFF.

- OFF: The FFT scope screen refreshes on each sweep. This setting displays the critical spectrum view.
- 2, 3, 4: The FFT scope screen averages 2 to 4 sweeps to smoothly display the spectrum.

Waveform Type (Default: Fill)

Selects the outline waveform display for the FFT scope screen.

- Fill: Displays only the waveform, in color.
- Fill+Line: Displays both the waveform and the outline, in color.

2. SCOPE OPERATION (ADVANCED)

SCOPE SET screen

Waveform Color (Current)

(Default: (R) 172 (G) 191 (B) 191)

Sets the waveform color for the currently received signals.

- ① Touch and select the R (Red), G (Green), or B (Blue) scale, and then rotate **(MULTI)** to adjust the level to between 0 and 255.
- ① The color is displayed in the box above the RGB scale.

Waveform Color (Line)

(Default: (R) 56 (G) 24 (B) 0)

Sets the waveform outline color for the currently received signals.

- ① Touch and select the R (Red), G (Green), or B (Blue) scale, and then rotate **(MULTI)** to adjust the level to between 0 and 255.
- ① The color is displayed in the box above the RGB scale.

Waveform Color (Max Hold)

(Default: (R) 45 (G) 86 (B) 115)

Sets the waveform color for the received signals maximum level.

- ① Touch and select the R (Red), G (Green), or B (Blue) scale, and then rotate **(MULTI)** to adjust the level to between 0 and 255.
- ① The color is displayed in the box above the RGB scale.

Waterfall Display

(Default: ON)

Turns the Waterfall display ON or OFF for the normal scope or Mini scope screen.

- ① On the Expanded scope screen, the Waterfall is always displayed.
 - OFF: Turns OFF the Waterfall display.
 - ON: Turns ON the Waterfall display.

Waterfall Speed

(Default: Mid)

Selects the Waterfall speed.

- Slow: Sets the Waterfall speed to Slow.
- Mid: Sets the Waterfall speed to Mid.
- Fast: Sets the Waterfall speed to Fast.

Waterfall Size (Expand Screen)

(Default: Mid)

Selects the Waterfall height in the Expand scope screen.

- Small: The same height as the Normal scope screen, only the FFT scope expands.
- Mid: The Waterfall height expands at the same ratio as the FFT scope.
- Large: Only the Waterfall height expands.

Waterfall Peak Color Level

(Default: Grid 8)

Selects the signal level that the Waterfall displays a peak color.

Higher signal levels are Red, Yellow, Green, Light-blue, Blue, and Black, in that order.

- Select between Grid 1 and Grid 8.

Waterfall Marker Auto-hide

(Default: ON)

Turns the Waterfall Marker Auto-hide function ON or OFF.

- OFF: The marker in the Waterfall zone stays ON.
- ON: The marker in the Waterfall zone is hidden 2 seconds after it stops in place.

Fixed Edges

144M

(Default: No.1 144.000–144.500 MHz)
(Default: No.2 144.500–145.500 MHz)
(Default: No.3 145.800–146.000 MHz)
(Default: No.4 144.000–144.200 MHz)

Sets the Upper and Lower Edge frequencies in the Fixed or Scroll-F mode. Four edges are assigned to each band.

NOTE:

- First set the lower Edge frequency.
- Set the upper Edge frequency within 1 MHz of the lower frequency.

- Settable range: 144.000 ~ 146.000 MHz



- ① Touch **(MULTI)** to select the upper and lower edge frequency, and then rotate **(MULTI)** or touch the keypad to edit the frequency.

430M

(Default: No.1 430.000–430.500 MHz)
(Default: No.2 432.500–433.500 MHz)
(Default: No.3 435.000–436.000 MHz)
(Default: No.4 430.000–430.200 MHz)

- Settable range: 430.000 ~ 450.000 MHz

1200M

(Default: No.1 1294.000–1294.500 MHz)
(Default: No.2 1294.500–1295.500 MHz)
(Default: No.3 1269.000–1270.000 MHz)
(Default: No.4 1260.000–1260.200 MHz)

- Settable range: 1240.000 ~ 13000.000 MHz

2. SCOPE OPERATION (ADVANCED)

Audio scope screen

This audio scope enables you to display the received signal's frequency component on the FFT scope, and its waveform components on the Oscilloscope. The FFT scope also has a waterfall.

Display the AUDIO SCOPE screen.

MENU » **AUDIO**

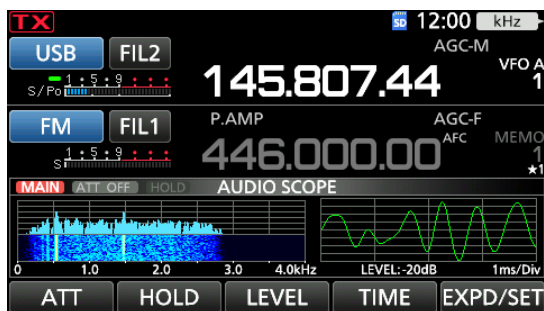

AUDIO SCOPE screen

Key	Action	
ATT	Touch	Selects the attenuator for the FFT scope. • 0 (OFF), 10, 20, or 30 dB
	Touch 1 second	Turns OFF the attenuator. (0 dB)
HOLD	Sets the Hold function to ON or OFF. • “[HOLD]” is displayed and freezes the current audio spectrum.	
LEVEL	Selects the Oscilloscope level. • 0, -10, -20, or -30 dB	
TIME	Selects the Oscilloscope sweep time. • 1, 3, 10, 30, 100, or 300 ms/Div	
EXPD/ SET	Touch	Selects the Expanded or Normal screen.
	Touch 1 second	Enters the AUDIO SCOPE SET screen.

• AUDIO SCOPE screen

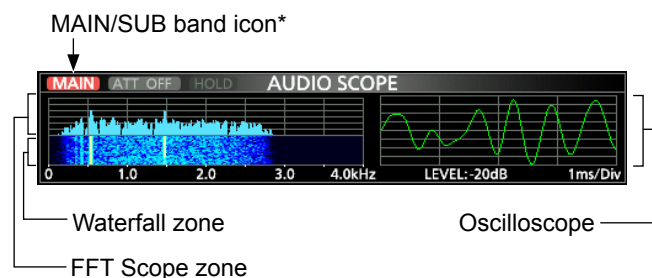

*Touching the MAIN/SUB band icon selects the displayed band.

◇ AUDIO SCOPE SET screen

This screen is used to set the FFT scope waveform type, color, Waterfall display and oscilloscope waveform color.

1. Display the AUDIO SCOPE screen.
MENU » **AUDIO**
2. Touch [EXPD/SET] for 1 second.
3. Touch to select the item to set.
(Example: “FFT Scope Waveform Type”)

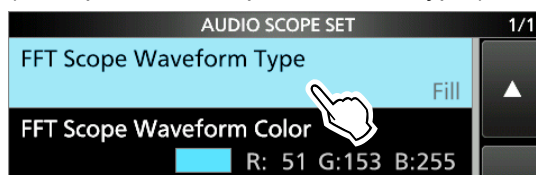

4. Touch the option to set.
① See below for details on the setting items and their options.
5. To close the AUDIO SCOPE SET screen, push **EXIT**.

TIP: You can set each item to its default by touching the item for 1 second, and then touching “Default” on the QUICK MENU.

FFT Scope Waveform Type (Default: Fill)

Select the type of waveform for the FFT scope.

- Line: Only the waveform outline is drawn.
- Fill: The full waveform is drawn in color.

FFT Scope Waveform Color

(Default: (R) 51 (G) 153 (B) 255)

Set the waveform color for the FFT scope.

- ① Touch and select the R (Red), G (Green) or B (Blue) scale, and then rotate **MULTI** to adjust the ratio from 0 to 255.
- ① The color is displayed in the box above the RGB scale.

FFT Scope Waterfall Display (Default: ON)

Turn the Waterfall display ON or OFF.

- OFF: Turns OFF the Waterfall display.
- ON: Turns ON the Waterfall display.

Oscilloscope Waveform Color

(Default: (R) 0 (G) 255 (B) 0)

Set the waveform color for the Oscilloscope.

- ① Touch and select the R (Red), G (Green) or B (Blue) scale, and then rotate **MULTI** to adjust the ratio from 0 to 255.
- ① The color is displayed in the box above the RGB scale.

Section 3

VOICE RECORDER FUNCTIONS

Recording a QSO audio	3-2
◇ Quick recording	3-2
◇ Basic recording.....	3-2
Playing back a QSO audio	3-3
◇ Fast forward while playing.....	3-3
◇ Rewind while playing.....	3-3
◇ Pause while playing.....	3-3
◇ Playing the previous file	3-3
◇ Playing the next file	3-3
◇ Moving to the beginning of the previous file	3-3
◇ Moving to the beginning of the next file.....	3-3
Playing back audio on a PC	3-4
Checking the folder or file information.....	3-4
Deleting files.....	3-5
Deleting folders.....	3-5
RECORDER SET screen	3-6
PLAYER SET screen.....	3-7

3. VOICE RECORDER FUNCTIONS

Recording a QSO audio

This transceiver is equipped with a QSO recorder not only for the receive audio, but also for the transmit audio.

This function is useful to make a QSO record, or to confirm your QSO with a rare entity's station, or on a DX'pedition. You can also use the function to repeatedly transmit the same voice message. The recorded contents are saved onto an SD card.

There are 2 ways to start recording.

- Push **QUICK** and select "<<REC Start>>."
- Push **MENU** and touch [RECORD].
 - ① The recorded audio is saved in the "Voice" folder on the SD card.

When the PTT Automatic Recording function, "PTT Auto REC" is set to ON in RECORDER SET, the recording automatically starts when you start transmitting.

MENU » **RECORD** > Recorder Set > **PTT Auto REC**

Audio recording band

You can select to record the received audio from only the selected band or both the Main and Sub bands.

MENU » **RECORD** > Recorder Set > **REC Operation**

TIP: About the icons

- While recording, "●" is displayed above the VFO/MEMO icon and the SD card icon next to the clock blinks blue.
- While pausing, "||" is displayed.



NOTE:

- To record a QSO, an SD card (user supplied) is required.
- Do not remove the SD card from the transceiver while recording. Otherwise the recording stops, and the card data may be corrupted or deleted.
- Once the recording starts, it pauses and resumes if the transceiver is turned OFF and ON again.
- The recording continues until you touch <<REC Stop>> or the free space on the SD card has run out.
- When the recording file's content becomes 2 GB, the transceiver continues to record, but to a new file.

◇ Quick recording

You can quickly record the received audio.

1. Push **QUICK**.
 - Opens the QUICK MENU screen.
2. Touch "<<REC Start>>."



- Starts recording.
- "Recording started." is briefly displayed.
- To stop recording, open the QUICK MENU screen again and touch "<<REC Stop>>."

◇ Basic recording

You can record both receive and transmit audio.

1. Open the QSO RECORDER screen.
MENU » **RECORD**

2. Touch "<<REC Start>>."



- Starts recording.
 - "Recording started." is briefly displayed.
 - To stop recording, touch "<<REC Stop>>."
3. To close the QSO RECORDER screen, push **EXIT**.

3. VOICE RECORDER FUNCTIONS

Playing back a QSO audio

You can playback the recorded QSO audio.

1. Insert the SD card in which the recorded audio is saved.
2. Open the PLAY FILES screen.

MENU » **RECORD > Play Files**

3. Touch the folder that the file you want to playback is saved.

① The folder is named in the following manner, "yyyymmdd" (yyyy: Year, mm: month, dd: day).

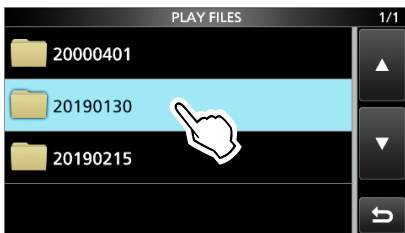

4. Touch the desired file.
 - Starts a playback.

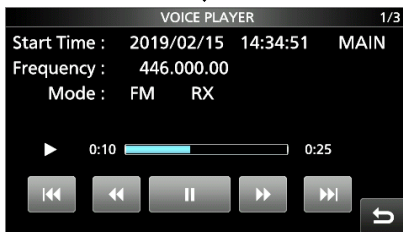
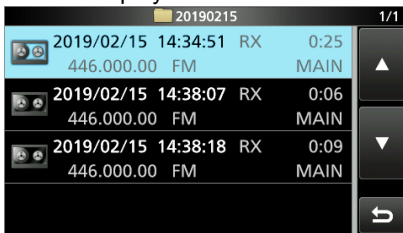

① Playback continues to the next file, and stops when the last file in the folder is played back.

5. To close the PLAY FILES screen, push **EXIT** several times.

Operating frequency and operating mode

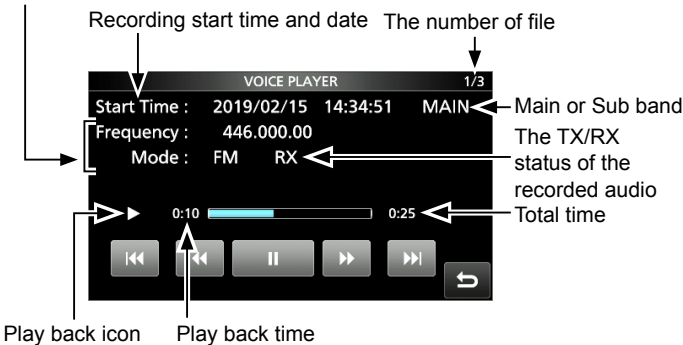

① The icon that shows how the signal is received is displayed.

- (No icon): The Normal mode (RF)
- TM: The Terminal mode
- MONI: The DV Repeater Monitor function

You can fast forward or rewind while playing back. You can change the skip time in the PLAYER SET screen. (Default: 10 seconds)

MENU » **RECORD > Player Set > Skip Time**

◇ Fast forward while playing

Touch **▶▶** to fast forward to the skip time point. (Default: 10 seconds)

◇ Rewind while playing

Touch **◀◀** to rewind to the skip time point. (Default: 10 seconds)

① If you touch **◀◀** within the first 1 second of the file, at the end of the previously recorded file will play back.

◇ Pause while playing

Touch **⏸**.

① **▶** is displayed while pausing.

① To cancel the pausing, touch **▶**.

◇ Playing the previous file

Touch **◀◀** to play the previous file.

① If there are other files in the folder, while the oldest file is playing back, touch **◀◀** to start playing the beginning of the file.

◇ Playing the next file

Touch **▶▶** to play the next file.

① If there are other files in the folder, while the most recent file is playing back, touch **▶▶** to stop the playback.

◇ Moving to the beginning of the previous file

• While paused, touch **◀◀** to move to the beginning of the previous file.

① To playback the file, touch **▶**.

• While paused, touch **◀◀** to return to the beginning of the file.

① To playback the file, touch **▶**.

◇ Moving to the beginning of the next file

While paused, touch **▶▶** to move to the beginning of the next file.

① To playback the file, touch **▶**.

3. VOICE RECORDER FUNCTIONS

Playing back audio on a PC

You can also playback the voice memory data on a PC.

① The recorded information (frequency, date, and so on) is not displayed.

1. Insert the SD card into your PC's SD card slot.
 - ① If your PC does not have an SD card drive, connect a memory card reader (user supplied) to the PC, and then insert the SD card into the reader.

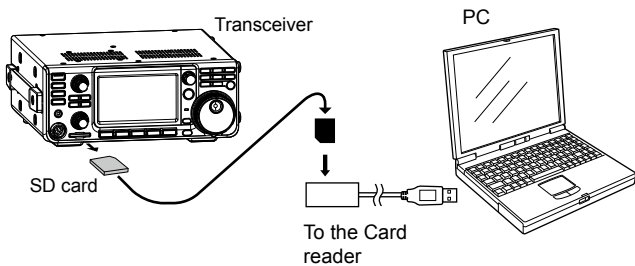

2. Open the "Voice" folder.
 - ① Refer to "SD Card" in the BASIC MANUAL.
3. Double-click the folder where the file you want to playback is saved.
 - ① The folders are titled based on the recorded date. (yyyymmdd)
4. Double-click the file that you want to playback.
 - The audio starts playing back.
 - ① The files are titled based on the date and time (yyyymmdd_hhmmss.wav).

NOTE:

- The operations while playing back may differ, depending on the application. Refer to the application's instruction manual for details.
- When the file does not playback, even if you double click the file, download an appropriate software. (Example: Windows Media® Player)

Checking the folder or file information

You can check the folder information (number of saved file, total size and created date) and recorded file information (operating frequency, mode, S-meter and recorded date, and so on).

Checking the folder information:

1. Open the PLAY FILES screen.
 - MENU** » **RECORD > Play Files**

2. Touch a folder for 1 second.

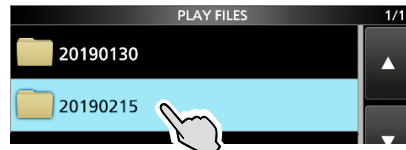

- Opens the QUICK MENU screen.

3. Touch "Folder Information."

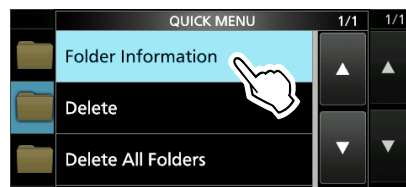

- The FOLDER INFORMATION screen is displayed.

4. To close the PLAY FILES screen, push **EXIT** several times.

Checking the file information:

1. Open the PLAY FILES screen.
 - MENU** » **RECORD > Play Files**

2. Touch a folder.

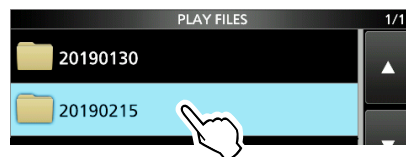

3. Touch a file to check its information for 1 second.

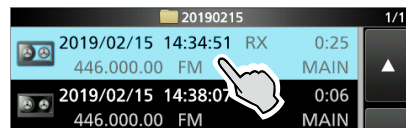

4. Touch "File Information."

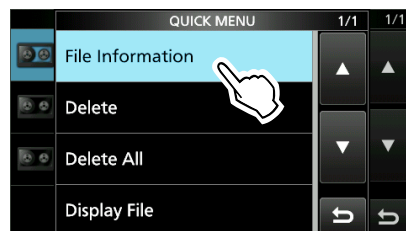

- The FILE INFORMATION screen is displayed.

5. To close the PLAY FILES screen, push **EXIT** several times.

3. VOICE RECORDER FUNCTIONS

Deleting files

1. Open the PLAY FILES screen.
MENU » **RECORD > Play Files**

- The folder list is displayed.

2. Touch the folder where the file you want to delete is saved.

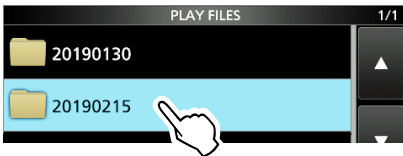

3. Touch the file that you want to delete for 1 second.

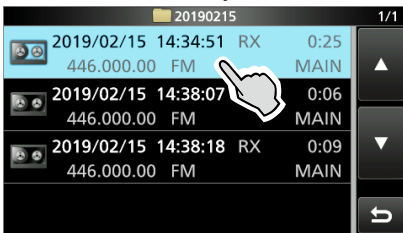

- Opens the QUICK MENU screen.

4. Touch "Delete."

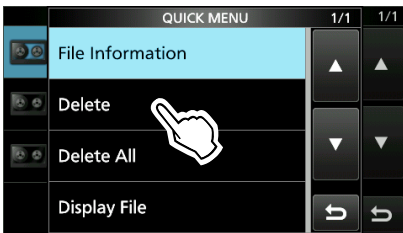

① If you want to delete all files in the selected folder, touch "Delete All."

- "Delete file?" is displayed.

5. Touch [YES].

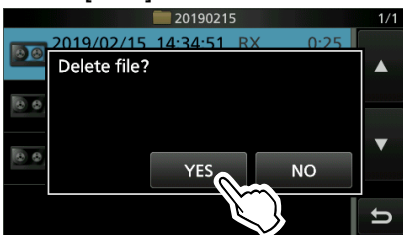

- The file is deleted and returns to the previous screen.

6. To close the PLAY FILES screen, push **EXIT** several times.

Deleting folders

NOTE: All the files in the folder are also deleted.

1. Open the PLAY FILES screen.
MENU » **RECORD > Play Files**

- The folder list is displayed.

2. Touch the folder you want to delete for 1 second.

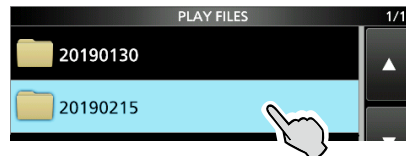

- Opens the QUICK MENU screen.

3. Touch "Delete."

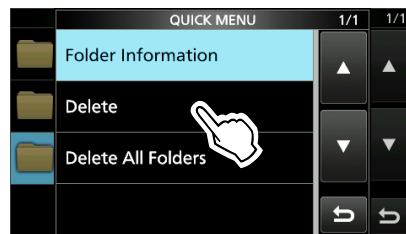

① If you want to delete all folders, touch "Delete All Folders."

4. Touch [YES].

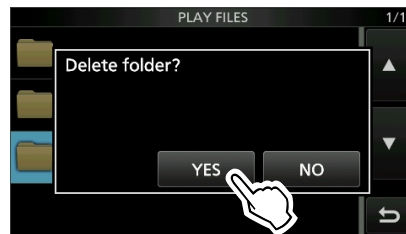

- The folder is deleted and returns to the previous screen.

5. To close the PLAY FILES screen, push **EXIT** several times.

3. VOICE RECORDER FUNCTIONS

RECORDER SET screen

You can change the recorder settings on this screen.

MENU » **RECORD > Recorder Set**

TX REC Audio (Default: Direct)

Select the transmit audio to record.

- Direct: Records the microphone audio.
- Monitor: Records the TX monitor audio.

RX REC Condition (Default: Squelch Auto)

Select the recording setting for receive.

- Always: Records even if no signal is received.
- Squelch Auto: Records only when the squelch opens.
(The recording will be paused when the squelch closes while recording.)

File Split (Default: ON)

Turn the File Split function ON or OFF.

- OFF: The audio is continuously recorded into the file even if you switch between transmit and receive or the squelch status changes between open and closed.
When the recording file's size becomes 2 GB, the transceiver continues to record, but to a new file.
- ON: While recording, if you switch between transmit and receive, or the squelch status changes between open and closed, a new file is automatically created in the same folder, and the audio is saved into the new one.

REC Operation (Default: MAIN/SUB Link)

Select the recording operation on the dual band display.

- MAIN/SUB Separate: The recording function is separately active/inactive on the selected band (MAIN band) when the function is started or stopped.
- MAIN/SUB Link: The recording function is simultaneously active/inactive on both MAIN and SUB bands when the function is started or stopped.
① On the single band display, only displayed band (MAIN or SUB) is recorded.

PTT Auto REC (Default: OFF)

Turn the PTT Automatic Recording function ON or OFF.

- OFF: The recording does not start, even if a signal is transmitted.
- ON: The recording automatically starts when a signal is transmitted.

The recording will stop when:

- 10 seconds has passed after the last transmission.
- 10 seconds has passed if no signal is received after the last transmission.
 - If you receive a signal within 10 seconds after the last transmission, the received audio is also recorded.
 - If you receive another signal within 10 seconds after the last reception, the received audio is also recorded.
- 10 minutes has past while operating with the squelch is open in the SSB, CW, RTTY, or AM mode.
- The frequency or operating mode is changed.

PRE-REC for PTT Auto REC (Default: 10sec)

Select whether or not to record the audio that is received before the PTT Automatic Recording function is activated.

- OFF: Does not record the audio.
- 5sec/10sec/15sec:
Records the audio that is previously received in this set period of time.

TIP: How to reset to the default setting

Touching the item or its option for 1 second displays the Quick menu, and then touch "Default" to reset to the default setting.

3. VOICE RECORDER FUNCTIONS

PLAYER SET screen

You can fast forward or rewind while playing back.
You can change the skip time in the PLAYER SET screen.

1. Open the PLAYER SET screen.

MENU » **RECORD > Player Set**

2. Touch "Skip Time."

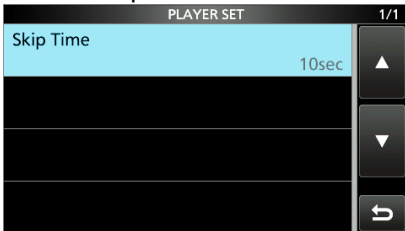

3. Touch your desired option.

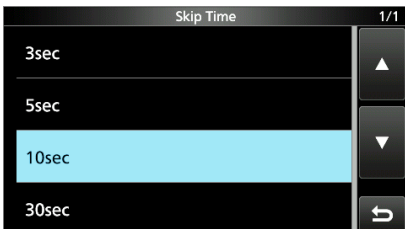

4. To close the PLAYER SET screen, push **EXIT** several times.

TIP: How to reset to the default setting

Touching the item or its option for 1 second displays the Quick menu, and then touch "Default" to reset to the default setting.

Section 4

VOICE TX MEMORY FUNCTION

Recording a Voice TX memory.....	4-2
◇ Recording.....	4-2
◇ Playing back.....	4-2
Entering a Voice TX memory name.....	4-3
Transmitting a Voice memory content.....	4-3
◇ Transmitting.....	4-3
◇ Repeatedly transmitting.....	4-4
◇ Adjusting the output level.....	4-4
VOICE TX SET screen.....	4-5

4. VOICE TX MEMORY FUNCTION

Recording a Voice TX memory

You can record up to 8 Voice transmit memories (T1 ~ T8) of up to one and a half minutes in each memory, onto an SD card. To transmit a recorded content using a Voice TX memory, first record the message, as described below.

- ① You can record up to 1 and a half minutes in each memory.
- ① A user supplied SD card is required to use the Voice TX memory function.
- ① You can also transmit the recorded content using an external keypad.

◆ Recording

1. Display the VOICE TX screen in the SSB, AM, FM or DV mode.

MENU » **VOICE**

2. Touch [REC/SET].



3. Touch the "REC" item.

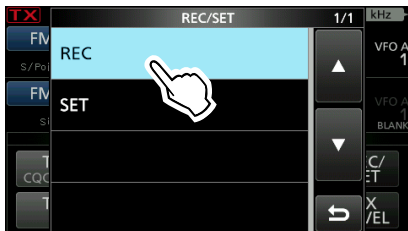

- Opens the VOICE TX RECORD screen.

4. Select the desired Voice memory "T1" ~ "T8." (Example: T1)

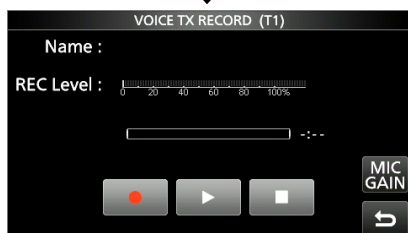
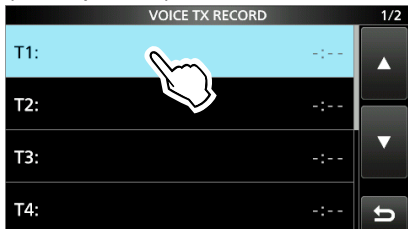

5. Touch to start recording.
 - Without holding down [PTT], speak into the microphone at your normal voice level.
 - ① Previously recorded content is overwritten.

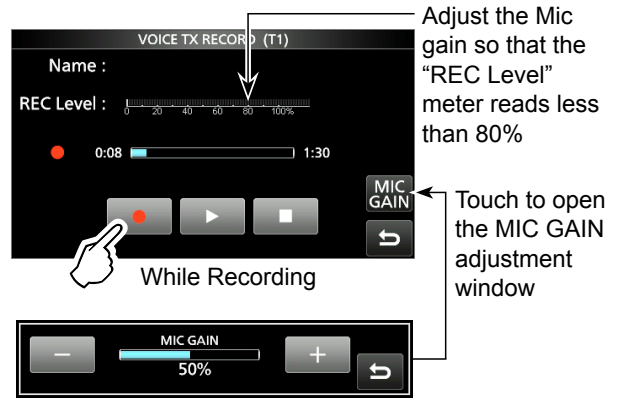

Adjust the Mic gain so that the "REC Level" meter reads less than 80%

Touch to open the MIC GAIN adjustment window

6. Touch to stop recording.
7. To close the VOICE TX RECORD screen, push **EXIT** several times.

◆ Playing back

1. On the selected memory's recording screen, touch to start playing back without transmitting.
 - ① To stop the playback, touch .

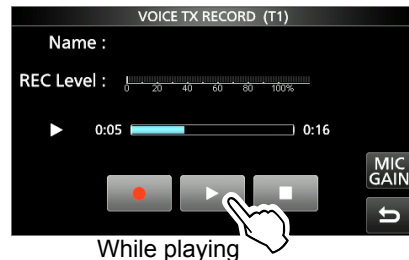

2. To close the VOICE TX RECORD screen, push **EXIT** several times.

TIP: How to clear the recorded content
Touching the Voice memory for 1 second in step 4 to the left, and then touch "Clear" in the Quick menu.

4. VOICE TX MEMORY FUNCTION

Entering a Voice TX memory name

You can assign a name to recorded Voice memories.

[Example: Entering “Contest” in Memory T1]

1. Display the VOICE TX RECORD screen in a Voice mode.

① Voice mode: SSB, AM, FM, or DV mode.

MENU » **VOICE > REC/SET > REC**

2. Touch [▲] or [▼] to display the desired Voice memories “T1” ~ “T4” or “T5” ~ “T8,” and then touch the memory for 1 second.

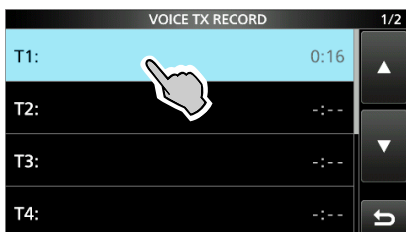

3. Touch “Edit Name.”

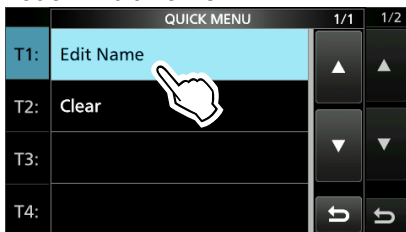

• Opens the Name editing screen.

4. Enter a name of up to 16 characters, and then touch [ENT] to save.

① See “Keyboard entering and editing” in the BASIC MANUAL for details.

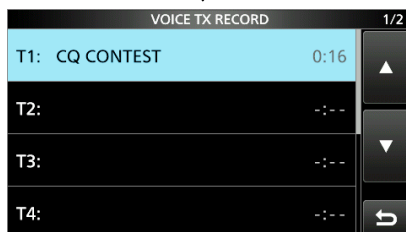
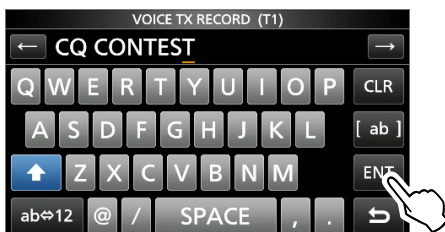

5. To close the VOICE TX RECORD screen, push **EXIT**.

Transmitting a Voice memory content

You can transmit the Voice TX memory contents once, or repeatedly. This is useful for transmitting your call sign, contest number or name in some contests, or repeatedly calling CQ.

◇ Transmitting

Transmits the prerecorded content. (p. 4-2)

1. Display the VOICE TX screen in a Voice mode.

① Voice mode: SSB, AM, FM, or DV mode.

MENU » **VOICE**

2. Touch the desired Voice memory key [T1] ~ [T8].
 - Transmits the recorded content once.

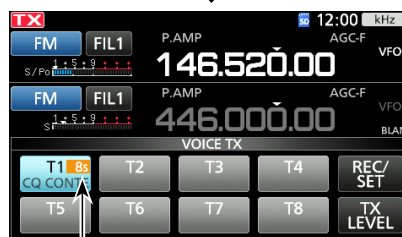
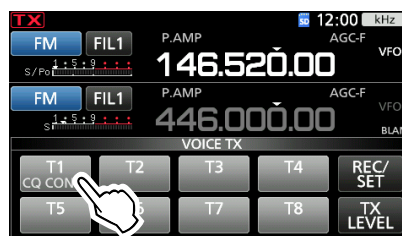

The transmission's remaining time

3. To close the VOICE TX screen, push **EXIT**.

TIP: How to cancel a Voice TX transmission

- Touch any keys other than [TX LEVEL] on the VOICE TX screen.
- Push **EXIT** or **V/M**.
- Touch the frequency's MHz digits or the Memory channel number.
- Turn OFF the transceiver.

① When “PTT Port Function” is set to “PTT Input,” you can cancel transmitting the recorded audio by pushing [PTT] on the microphone.

When an external keypad is connected:

You can transmit the preset contents in the Voice TX memory (T1 ~ T4) from an external device by setting the “External Keypad,” and then connecting an external keypad to [MIC] on the IC-9700.

① Memory “T5 ~ T8” cannot be sent from the external keypad.

MENU » **SET > Connectors > External Keypad > VOICE**

4. VOICE TX MEMORY FUNCTION

Transmitting a Voice memory content

◇ Repeatedly transmitting

1. Display the VOICE TX screen in a Voice mode.
 ① Voice modes: SSB, AM, FM and DV.
MENU » **VOICE**
2. Touch the desired Voice memory key [T1] ~ [T8] for 1 second.
 • Repeatedly transmits the recorded content.

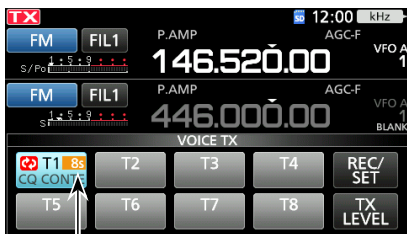
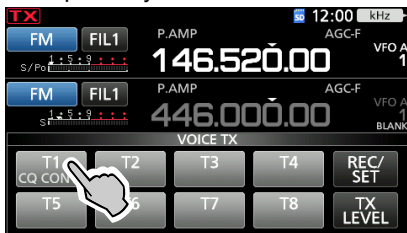

The transmission's remaining time

① Information

- The recorded content is repeatedly transmitted for 10 minutes, unless you manually stop transmission by touching the selected memory.
 - The Memory Timer counts down.
 - “8s” is displayed while repeatedly transmitting.
 - You can set the pause interval between the repeated transmissions in the “Repeat Time” item on the VOICE TX SET screen. During this interval, the transceiver returns to receive. (p. 4-5).
 - After 10 minutes have passed, and all of the recorded content in the memory is transmitted, the transceiver automatically returns to receive.
 - When a signal is received in the interval between transmissions, the transceiver pauses the next transmission until the signal disappears. However, if the squelch is set to open, the transceiver repeatedly transmits after the repeat interval time expires, even signals are received.
3. To close the VOICE TX screen, push **EXIT**.

TIP: If the “DATA OFF MOD” is set to “ACC,” “USB,” or “LAN,” Voice TX memories can not be transmitted.

MENU » **SET > Connectors > MOD Input > DATA OFF MOD**

◇ Adjusting the output level

Adjust the Voice TX memory level.

1. Display the VOICE TX screen in a Voice mode.
 ① Voice modes: SSB, AM, FM and DV.
MENU » **VOICE**
2. Touch [TX LEVEL].

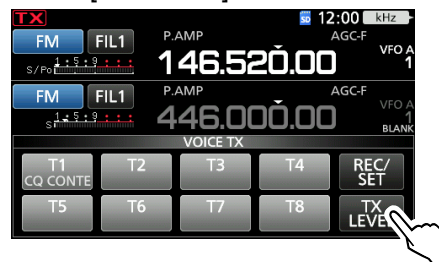

3. Touch any Voice memory key other than [T4] or [T8]. ([T1] ~ [T3], [T5] ~ [T7])
 • The transceiver automatically transmits.
 ① To adjust the Transmit voice level using [T4] or [T8], reverse steps 2 and 3.

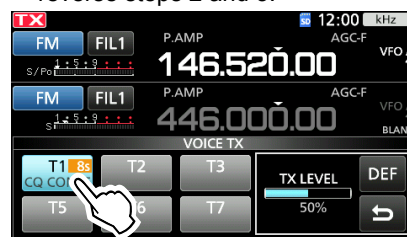

4. While transmitting, rotate **MAIN DIAL** to adjust the transmit voice level.
 ① Pushing [DEF] for 1 second returns the value to the default.
 ① Adjusting TX LEVEL too high may result in an over modulation and transmit signal distortion.
5. To save and close the VOICE TX screen, push **EXIT** several times.

4. VOICE TX MEMORY FUNCTION

VOICE TX SET screen

This Set screen is used to set the Automatic Monitor function and the Transmit Repeat Interval.

1. Display the VOICE TX SET screen.

MENU » **VOICE > REC/SET > SET**

2. Touch the setting item. (Example: Auto Monitor)

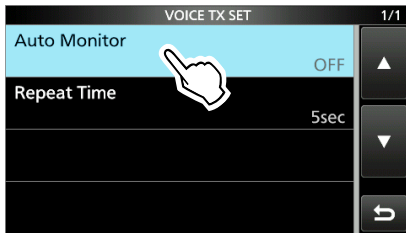

3. Select an option or set the time.

① See below for details of the setting items and their options.

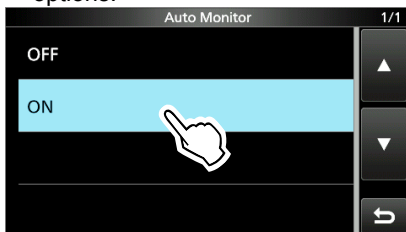

4. To close the VOICE TX SET screen, push **EXIT**.

Auto Monitor (Default: ON)

Turn the Automatic Monitor function for recorded audio contents transmission, ON or OFF.

- ON: Automatically monitors transmit audio when sending a recorded audio.
- OFF: Monitors transmit audio only when the Monitor function is ON.

Repeat Time (Default: 5sec)

Set the repeat interval to repeat the voice transmission. The transceiver repeatedly transmits the recorded content at this interval.

- Range: 1 ~ 15 seconds

① Repeatedly transmits the recorded content for up to 10 minutes.

① After 10 minutes have passed, and all of the recorded content in the memory is transmitted, the transceiver automatically returns to receive.

TIP: How to reset to the default setting

Touching the item or its option for 1 second displays the Quick menu, and then touch "Default" to reset to the default setting.

Memory channels	5-2
Selecting a Memory channel	5-2
◇ Selecting with (MULTI)	5-2
◇ Selecting a channel on the MEMORY screen	5-2
◇ Selecting using the keypad	5-2
◇ Selecting a Call channel	5-2
Entering memory channel contents	5-3
Copying the Memory channel contents	5-4
◇ Copying to the VFO	5-4
◇ Copying to the another Memory channel	5-4
Entering a memory name	5-5
Clearing a memory channel.....	5-5
About the MEMORY screen	5-6
Memo Pad	5-6
◇ Saving the contents into a Memo Pad.....	5-6
◇ Calling up the Memo Pads	5-6

5. MEMORY OPERATION

Memory channels

The Memory mode enables you to quickly select often-used frequencies, modes and other parameters. You can change the operating frequency, mode and so on while operating in the Memory mode.

① You can temporarily tune the memory channel frequency by rotating **(MAIN DIAL)**.

Memory channel	Displayed
1 to 99	Regular memory channels. 1 frequency, 1 mode, 1 filter, memory name, tone settings (including tone frequencies for repeater and tone squelch) and select memory scan setting in each memory channel.
1A/1B ~ 3A/3B	Scan Edge memory channels. 1 frequency and 1 mode in each memory channel as scan edges for programmed scans.
C1/C2	Call channels. ① Cannot be left blank.

Selecting a Memory channel

◇ Selecting with **(MULTI)**.

1. Push **(V/M)** to select the Memory mode.
2. Push **(KHz M-CH)**.
3. Rotate **(MULTI)** until you select the Memory channel you want to use.
① You can also select the memory channel with [UP] and [DOWN] keys on the microphone.

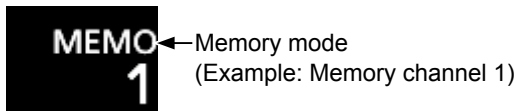

◇ Selecting a channel on the MEMORY screen

1. Push **(V/M)** to select the Memory mode.
2. Display the MEMORY screen.
(MENU) » **(MEMORY)**
3. Rotate **(MULTI)** or **(MAIN DIAL)**, or touch [UP] or [DOWN] until the desired Memory channel is shown on the screen.
4. Touch the Memory channel you want to use.

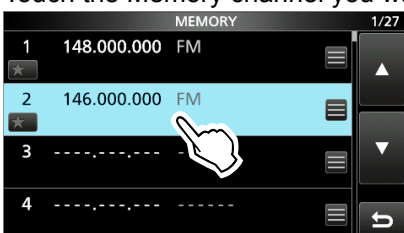

- The channel is selected and automatically closes the MEMORY screen.

◇ Selecting using the keypad

1. Push **(V/M)** to select the Memory mode.
2. Touch the MHz digit on the operating frequency.
• The BAND STACKING REGISTER screen is displayed.

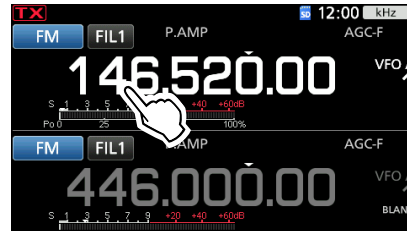

3. Touch [F-INP].
• The F-INP screen is displayed.



4. Enter the desired memory channel number.
(Example: memory channel 2)



5. Touch [MEMO] to set the entered memory channel.

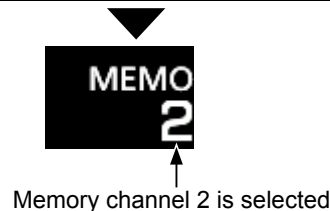

◇ Selecting a Call channel

1. Push **(CALLDR)** to select the Call channel mode.
2. Rotate **(MULTI)** to select the Call channel you want to use.
3. To return to the previous screen, push **(CALLDR)**.

5. MEMORY OPERATION

Entering memory channel contents

The operating frequency, operating mode, IF filter bandwidth, and so on can be entered to each memory channel.

NOTE: New content you enter will overwrite any content already in the selected memory.

1. Push **[V/M]** to select the VFO mode.
2. Set the frequency and operating mode.
3. Hold down **[kHz/M-CH]** for 1 second.

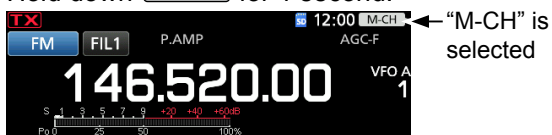

4. Rotate **[MULTI]** to select the Memory channel to enter the contents set in step 2. (Example: 2)
① If "BLANK" is displayed under the selected memory channel number, it is a blank channel, meaning that no contents are entered in that channel.
5. Touch the Memory channel number.

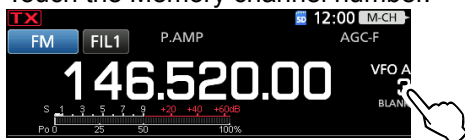

6. Touch **[MW]** for 1 second until BLANK disappears from below the channel number.

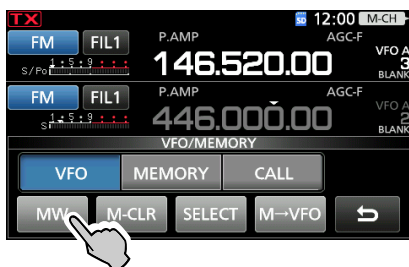

- The contents are entered in the selected Memory channel, and BLANK is not displayed below the channel number.
7. To close the VFO/MEMORY screen, push **[EXIT]**.

Copying the Memory channel contents

You can copy a Memory channel contents to the VFO or another memory channel.

◇ Copying to the VFO

1. Push **[V/M]** to select the Memory mode.
2. Push **[kHz/M-CH]**.
3. Rotate **[MULTI]** to select the channel to be copied.
(Example: Memory channel 2)

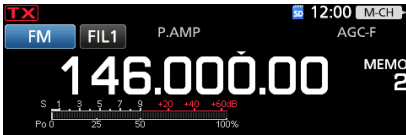

4. Hold down **[V/M]** for 1 second.
 - A beep sounds and the selected memory contents are copied to the VFO.
5. Push **[V/M]** to select the VFO mode.

◇ Copying to the another Memory channel

1. Push **[V/M]** to select the Memory mode.
2. Push **[kHz/M-CH]**.
3. Rotate **[MULTI]** to select the channel to be copied.
(Example: Memory channel 3)
4. Open the MEMORY screen.

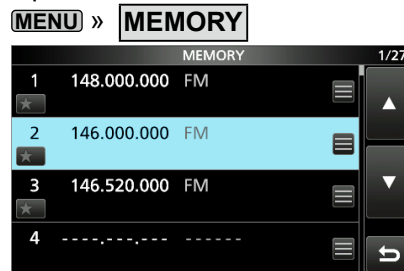

5. Rotate **[MAIN DIAL]** to select the channel to write the copied contents to.
(Example: Memory channel 5)
① Do not rotate **[MULTI]**. Select the channel by rotating **[MAIN DIAL]**.
6. Touch **[MEMO]** of the selected channel.



7. Touch "Memory Write."

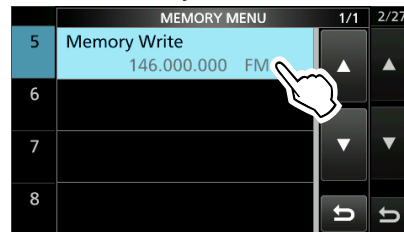

8. Touch [Yes].

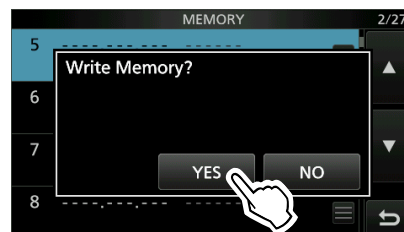

- A beep sounds and the selected memory contents are copied.
9. To close the MEMORY screen, push **[EXIT]**.

5. MEMORY OPERATION

Entering a memory name

Except for the blank channels, you can assign a name to all memory channels, including scan edges. The names will be displayed along with the frequency, mode and filter number.

1. Display the MEMORY screen.

MENU » **MEMORY**

2. Rotate **(MULTI)** to select the channel to enter a name. (Example: Memory channel 2)
3. Touch  of the selected channel.

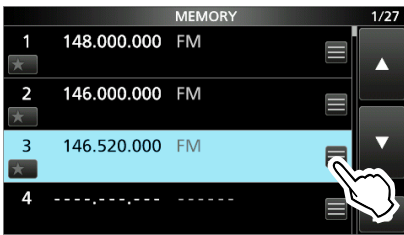

4. Touch "Edit Name."

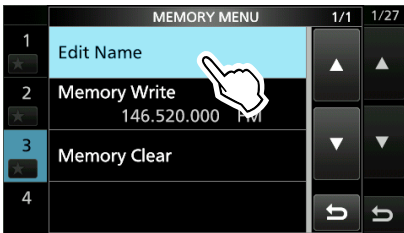

① Touch "Memory Clear" to clear any memory contents and name.

5. Enter a name, and then touch [ENT]. (Example: CQ)

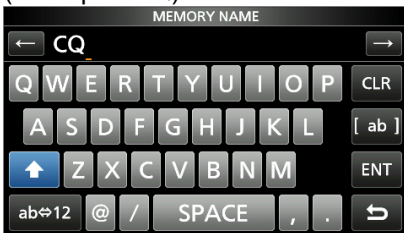

① See "Keyboard entering and editing" in the BASIC MANUAL for details.

6. To close the MEMORY screen, push **EXIT**.

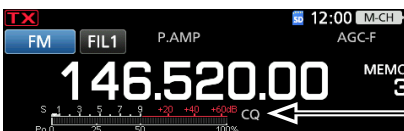

Memory name

① The Memory name is not displayed when the Mini scope screen (BASIC MANUAL) or expanded screen is displayed.

① You can also select not to display the Memory name on the standby screen.

MENU » **SET > Display > Memory Name**

Clearing a memory channel

You can clear a no-longer-used memory channel and reset it as a blank channel, except for the program channels (1A/1B ~ 3A/3B) and Call channels (C1 and C2).

1. Push **(V/M)** to select the Memory mode.
2. Push **(kHzM-CH)**.
3. Rotate **(MULTI)** to select the channel to clear. (Example: Memory channel 2)
4. Touch the channel number.

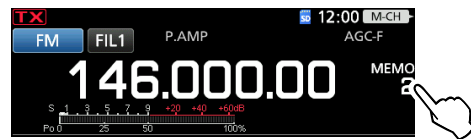

5. Touch [M-CLR] for 1 second to clear the memory channel.



6. To close the VFO/MEMORY screen, push **EXIT**.

5. MEMORY OPERATION

About the MEMORY screen

MENU » **MEMORY**

You can edit Memory channel contents on the MEMORY screen.

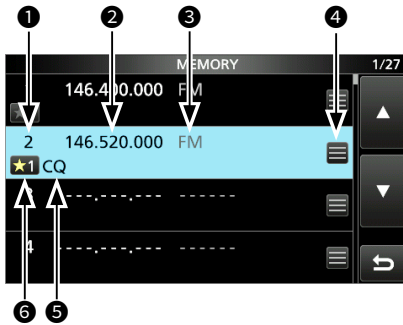

- 1 Memory channel number**
 Displays the memory channel number.
 ① 1A/1B ~ 3A/3B, C1 and C2 cannot be left blank.
- 2 Frequency**
 Displays the entered frequency.
- 3 Operating mode**
 Displays the selected operating mode.
- 4 Memory menu**
 Touch to display the MEMORY MENU.
 ① You can select between “Edit Name,” “Memory Write” and “Memory Clear.”
- 5 Memory name**
 Displays the memory name, if entered.
 ① See the previous page for details.
- 6 Memory select icon (1 ~ 99)**
 Touch this icon to set the Select number “★1,” “★2,” “★3” or OFF. See page 6-6 for the Select Memory scan.
 ① You can also touch the icon for 1 second to display the SELECT ALL CLEAR screen, and then select the desired item to reset the Select number.

① About the QUICK MENU

While selecting a memory channel with memory contents, push **QUICK** to display the QUICK MENU, where you can select “SELECT,” “Edit Name,” “Memory Write,” “Memory Clear,” or “SELECT All Clear.”

Memo Pad

There are 5 Memo Pads as the default to save frequencies and operating modes for easy writing and recall. You can increase the Memo Pads to 10 in “Memo Pad Quantity.”

MENU » **SET > Function > Memo Pad Quantity**

- ① The Memo Pads are separate from memory channels.
- Memo Pads are convenient when you want to temporarily memorize a frequency and operating mode, such as when you find a DX station in a pile-up, or when the desired station is busy for a long time and you want to temporarily search for other stations.

◇ Saving the contents into a Memo Pad

1. Select the operating band (MAIN or SUB).
2. Push **V/M** to select the VFO mode.
3. Set the frequency and operating mode, and then push **MPAD** for 1 second.
 - A beep sounds.
 - ① When you save up to the set number of Memo Pads in “Memo Pad Quantity,” the oldest Memo Pad is automatically cleared for the new Memo Pad.

NOTE: Each Memo Pad must have its own unique contents. The Memo Pads with identical content cannot be saved.

◇ Calling up the Memo Pads

- You can call up the saved Memo Pads.
1. Select the operating band (MAIN or SUB).
 2. Push **MPAD** several times until the desired Pad is displayed.
 - ① Pushing **MPAD** selects the Memo Pads.
 - ① The calling up starts with the most recently saved Pad.

About the MEMO PAD screen

The MEMO PAD screen displays the saved contents in a list, in which you can select or delete the saved contents.

MENU » **MPAD**



TIP: If you change the frequency or operating mode called up from Memo Pads, the contents are automatically updated in a temporary Pad.

Key	Action
▲/▼	Scrolls through the list.
DEL	Touch 1 second Deletes the selected Memo Pad.
DEL ALL	Touch 1 second Deletes all the Memo Pads.
EXPAND	Select to display the MEMO PAD list in a normal or larger size screen.

Section 6 SCANS

Scan types.....	6-2
Preparation.....	6-2
◇ Squelch status.....	6-2
SCAN screen.....	6-3
SCAN SET screen.....	6-4
Programmed scan.....	6-5
◇ Programmed scan operation.....	6-5
Memory scan.....	6-6
◇ Memory scan operation.....	6-6
◇ Setting the Select Memory channels.....	6-6
◇ Select Memory scan operation.....	6-7
◇ Mode Select scan operation.....	6-7
Δ F scan and Fine Δ F scan.....	6-8
◇ Δ F scan operation.....	6-8
Temporary Skip function.....	6-8

Scan types

Scan types	Operation (Scan function is enabled in the Main band)
VFO SCAN	Used to detect a signal by automatically changing the frequency of the VFO mode.
Programmed scan	Repeatedly scans between two Scan Edge frequencies. The Edge frequencies are programmable, and are preset in P1 and P2 as the default. (p. 6-5)
Fine Programmed scan	If the squelch opens while scanning, the tuning step changes to 10 Hz. This reduces the scan speed, but the transceiver keeps scanning.
MEMORY SCAN	Used to detect a signal by automatically scanning the memories in the Memory mode.
Memory scan	Repeatedly scans all entered Memory channels.
Select Memory scan	Repeatedly scans Select Memory channels.
Select Mode scan	Repeatedly scans Memory channels with the same operating mode.
Δ F SCAN	Repeatedly scans within the Δ F span area. The scan starts from the center frequency. (p. 6-8)
Fine Δ F scan	If the squelch opens while Δ F scanning, the tuning step changes to 10 Hz. This reduces the scan speed, but the transceiver keeps scanning.

Preparation

◇ Squelch status

The scan work with the selected band's squelch status. Be sure to adjust the squelch level according to your operating environment.

- ① Normally, set (AF \odot RF/SQL) to the point where noise just disappears, and the TX/RX indicator goes OFF.
- ① When (AF \odot RF/SQL) operates as only an RF gain control, you cannot adjust the squelch level.

MENU » **SET > Function > RF/SQL Control**

When the scan starts with the squelch open:

When the tuning step is 1 kHz or less, the scan continues until it is manually stopped—it does not pause even if signals are detected.

When the tuning step is 5 kHz or more, the scan pauses on each step when the Scan Resume function is ON. It does not pause when the function is OFF.

When the scan starts with the squelch closed:

The scan stops when a signal is detected, regardless of the tuning step.

- When the Scan Resume function is ON, the scan pauses for 10 seconds after detecting a signal, then resumes 2 seconds after the signal disappears.

6. SCANS

SCAN screen

To display the SCAN screen, push **MENU**, and then touch [SCAN].

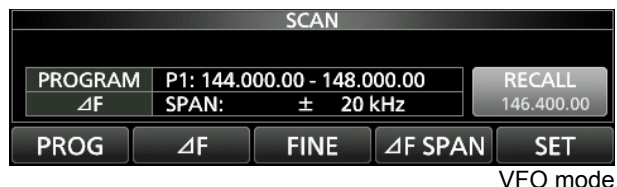

VFO mode

▼ ▲ Push **V/M**.



Memory mode

Key	Action	
PROG	Touch	Starts or cancels the Programmed scan.
	Touch 1 second	Displays the SCAN SELECT screen.
MEMO	Touch	Starts or cancels the Memory scan.
	Touch 1 second	Displays the SCAN SELECT screen.
ΔF	Starts or cancels the ΔF scan.	
FINE	While Programmed scanning, touch to switch to the Fine Programmed scan.	
	While ΔF scanning, touch to switch to the Fine ΔF scan. ① In the Memory mode, this key is displayed when a ΔF scan is started.	
SELECT	Touch	Selects a Memory channel (except 1A/1B ~ 3A/3B, C1 and C2) to set as a Select Memory channel. “★1,” “★2,” “★3,” and “(no icon)” are alternately displayed.
	Touch 1 second	Displays the SELECT ALL CLEAR screen.
SEL No.	Selects the Select scan number for the Select Memory scan. Each time you touch [SEL No.], “★1,” “★2,” “★3,” and “★1,2,3” are alternately displayed.	
ΔF SPAN	Touch to select the ΔF span between ±5.0 kHz, ±10 kHz, ±20 kHz, ±50 kHz, ±100 kHz, ±500 kHz, and ±1 MHz.	
SET	Displays the SCAN SET screen.	

- Push **SCAN** to display the Scan Select window.
 - ① If you push **SCAN** while scanning, the scan is canceled.
- Hold down **SCAN** for 1 second to start the previously selected scan.

6. SCANS

SCAN SET screen

1. Display the SCAN screen.

MENU » **SCAN**

2. Touch [SET].

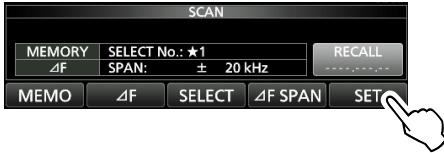

3. Touch an item to set. (Example: SCAN Speed)

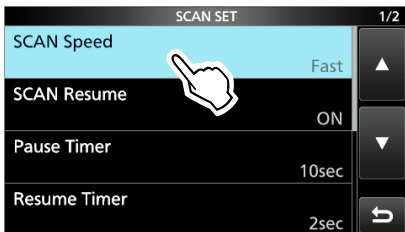

4. Touch an option. (Example: Slow)

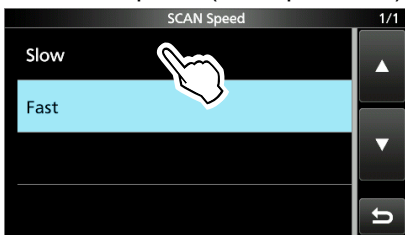

5. To close the SCAN SET screen, push **EXIT**.

SCAN Speed (Default: Fast)

Set the desired scan speed to slow or fast.

- Slow: Scan speed is slow.
- Fast: Scan speed is fast.

SCAN Resume (Default: ON)

Set the Scan Resume function to ON or OFF.

- OFF: When a signal is detected, cancels the scan.
- ON: When a signal is detected, the scan pauses for 10 seconds, then resumes. Two seconds after the signal disappears, the scan resumes.

Pause Timer (Default: 10sec)

When Scan Resume is ON, select the Scan Pause Timer. When receiving a signal, the scan pauses for this set period of time.

- 2 ~ 20sec: When a signal is received, the scan pauses for 2 ~ 20 seconds (in 2 second steps).
- HOLD: The scan pauses on a received signal until the signal disappears.

Resume Timer (Default: 2sec)

Select the scan Resume Timer. When a received signal disappears, the scan resumes after this set period of time passed.

- 0sec: The scan resumes immediately after the signal disappears.
- 1 ~ 5sec: The scan resumes 1 ~ 5 seconds after the signal disappears.
- HOLD: The scan remains paused for the Pause Timer setting, even if the signal disappears.

Temporary Skip Timer (Default: 5min)

Set the Temporary Skip Timer. The unwanted frequencies that are set as Skip channels (PSKIP or SKIP) are skipped for this set period of time during a scan.

- ① This timer is activated for the VFO scan, Memory scan, and DR scan.
- 5min/10min/15min: Skip channels are skipped for the set period of time.
- While Scanning: Skip channels are skipped until the Scan is stopped.
- While Powered ON: Skip channels are skipped until the receiver power is turned OFF.

TIP: How to reset to the default settings

Touching an item or its option for 1 second displays the Quick menu, and then touch "Default" to reset to the default setting.

Programmed scan

Programmed scan and Fine Programmed scan

Repeatedly scans between two Scan Edge frequencies (1A/1B ~ 3A/3B channels).

- ① To change the Scan Edge Memory channels, see “Entering memory channel contents” (p. 5-3) for details.
- ① If the same frequencies are entered into the Scan Edge Memory channels, the Programmed scan does not start.
- ① The Fine Programmed scan is most effective in the SSB, CW, and RTTY modes.

◇ Programmed scan operation

1. Select the VFO mode.
2. Select the operating mode and tuning step. (Example: USB, 1 kHz)
3. Display the SCAN screen.

MENU » **SCAN**

4. Touch [PROG] for 1 second.

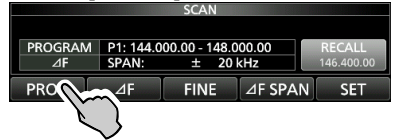

5. Touch the frequency range to scan. (Example: P1)

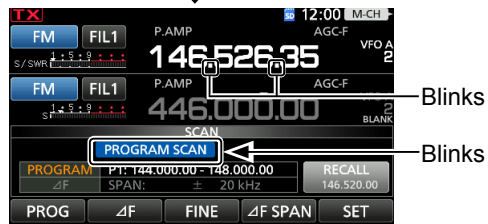
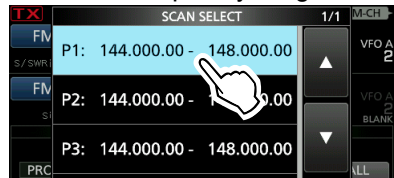

- The Programmed scan starts.
- ① When a signal is detected, the scan pauses according to the “SCAN Resume” setting, and then resumes.
- ① You can change the tuning step by touching kHz.
- ① To cancel the scan, touch [PROG].

6. Touch [FINE] to switch to the Fine Programmed scan.

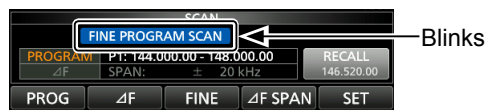

- The tuning step changes to the 50 Hz step.
 - ① When a signal is detected, the tuning step changes to the 10 Hz step.
 - ① Touch [FINE] again to return to the Programmed scan.
7. To close the SCAN screen, push **EXIT**.

Memory scan

Memory scan

Blank channels are skipedpd

Repeatedly scans all entered Memory channels (except 1A/1B ~ 3A/3B, C1 and C2).
Blank (not entered) Memory channels are skipped.
① If two or more Memory channels are not entered, the Memory scan does not start.

Select Memory scan

★1, ★2 and ★3 show that the channel is specified as a Select Memory.

(Example: Select Memory channel ★1)

Repeatedly scans Select Memory channels (★1, ★2, ★3).
① If two or more Memory channels are not designated as Select Memory channels, the Select Memory scan does not start.

◇ Memory scan operation

1. Select the Memory mode.
2. Display the SCAN screen.
MENU » **SCAN**
3. Touch [MEMO] for 1 second.
4. Touch [MEMORY SCAN].

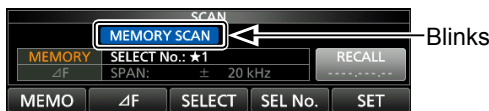
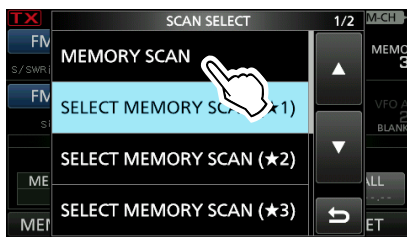

- Memory scan starts.
 - ① When a signal is detected, the scan pauses according to the "SCAN Resume" setting, and then resumes.
 - ① To cancel the scan, touch [MEMO] again.
5. To close the SCAN screen, push **EXIT**.

◇ Setting the Select Memory channels

1. Select the Memory mode.
2. Display the MEMORY screen.
MENU » **MEMORY**
3. Touch the SELECT icon to set the channel as the Select Memory channel. (Example: ★1)
 - Each touch selects "★1," "★2," "★3," and "(no icon)."
 - "★1" is set to Memory channel 1.

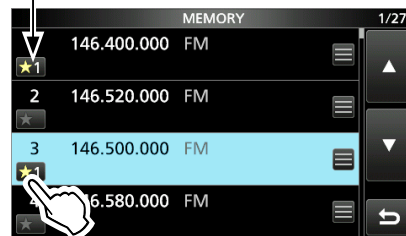

Touch to set the channel as a Select Memory channel.

① Setting Select Memory channels on the SCAN screen.

1. Push **KHz M-CH**.
2. Rotate **MULTI** to select memory channels to set as Select Memory channels.
3. Touch [SELECT] to set the selected number.
 - "★1," "★2," "★3," and "(no icon)" are alternately displayed.
4. Repeat steps 2 and 3 to set more than two Select Memory channels.

6. SCANS

Memory scan

◇ Select Memory scan operation

1. Select the Memory mode.
2. Display the SCAN screen.

MENU » **SCAN**

3. Touch [MEMO] for 1 second.

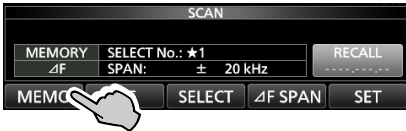

4. Touch the Select Memory channel number. (Example: ★1)

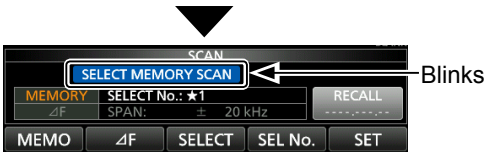
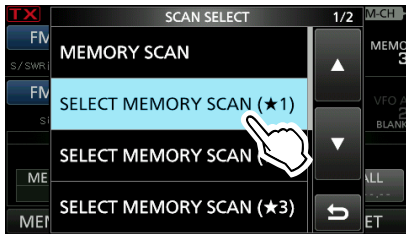

- The Select Memory scan starts.
 - ① When a signal is detected, the scan pauses according to the “SCAN Resume” setting, and then resumes.
 - ① Touch [SELECT] to return to the regular Memory scan.
 - ① While scanning, touch [SEL No.] to select the Select Memory scan number.
 - To cancel the scan, touch [MEMO].
5. To close the SCAN screen, push **EXIT**.

Clearing all Select Memory channels

1. Touch [SELECT] for 1 second on the SCAN screen.
 - The SELECT ALL CLEAR screen is displayed.
2. Touch the Select Memory channels to clear.



Mode Select scan

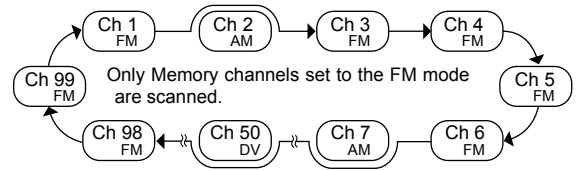

(Example: FM channels)

Repeatedly scans memory channels (except 1A/1B ~ 3A/3B, C1 and C2) that are set to the mode selected before starting the scan.

◇ Mode Select scan operation

1. Select the Memory mode.
2. Set the operating mode.
3. Open the SCAN screen.

MENU » **SCAN**

4. Touch [MEMO] for 1 second.

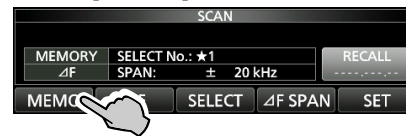

5. Touch [MODE SELECT SCAN].

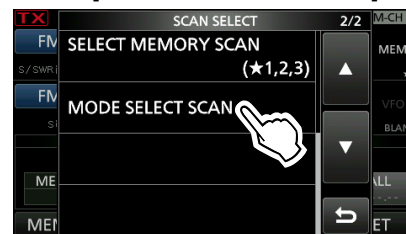

- The Mode Select scan starts.
 - ① When a signal is detected, the scan pauses according to the “SCAN Resume” setting, and then resumes.
 - To cancel the scan, touch [MEMO].
6. To close the SCAN screen, push **EXIT**.

ΔF scan and Fine ΔF scan

ΔF scan and Fine ΔF scan
 (Example: Span: ±10 kHz)

Repeatedly scans within the ΔF span area. The scan starts from the center frequency.

① In fine scan (programmed or ΔF), the scan speed decreases when the squelch opens, but the transceiver keeps scanning. The scan tuning step changes to 10 Hz when the squelch opens.

◇ ΔF scan operation

1. Set the center frequency.
2. Set the operating mode and tuning step.
 (Example: FM, 1 kHz)
 ① You can also change these settings while scanning.
3. Display the SCAN screen.
MENU » **SCAN**
4. Touch [ΔF SPAN] several times to select the span.
 • Each touch changes the span.

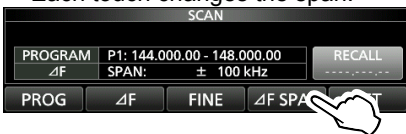

5. Touch [ΔF].
 • The ΔF scan starts.

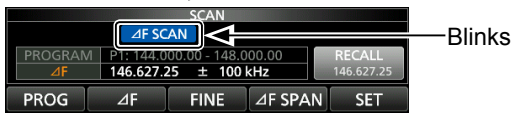

- ① When a signal is detected, the scan pauses according to the “SCAN Resume” setting, and then resumes.
- ① To turn the TS function to scan by the frequency step setting, touch the 100 kHz digit on the frequency readout.
- ① To cancel the scan, touch [ΔF] again.

6. To switch to the Fine ΔF scan, touch [FINE].
 • The scan frequency step changes to 50 Hz.

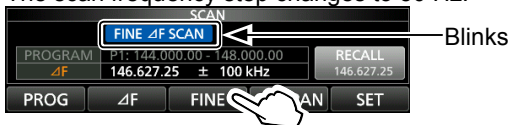

- ① Touching [FINE] switches between the ΔF scan and the Fine ΔF scan.

7. To close the SCAN screen, push **EXIT**.

Temporary Skip function

This function temporarily skips unwanted frequencies (or memory channels) during a scan for the set period of time or condition, without changing the Skip Channel setting.

1. Start a scan.
 • When a signal is detected, the scan pauses.
2. Push **QUICK**.
3. Touch [Temporary Skip Set].

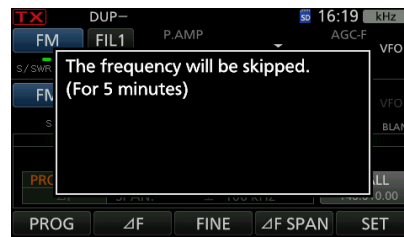
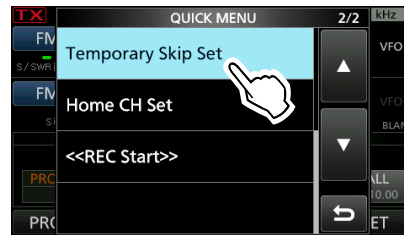

- Scan resumes.

TIP:

- Up to 20 Temporary Skip frequencies or Memory channels can be set. When the 21st frequency or Memory channel is set, the oldest setting is automatically deleted.

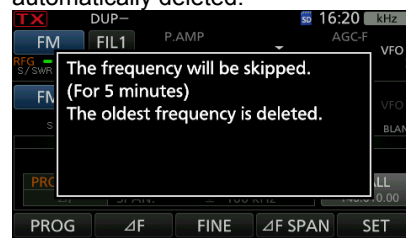

- The Temporary Skip function is canceled when the Temporary Skip Timer (Default: 5 min) has passed, or when selecting “Temporary Skip Cancel” in the Quick menu.

Section 7 OTHER FUNCTIONS

Measuring SWR	7-2
Protection function.....	7-2
Selecting the display type and font.....	7-2
◇ Selecting the display background.....	7-2
◇ Selecting the display font	7-2
NTP function.....	7-3
◇ Using the NTP Time Synchronize function.....	7-3
◇ Using the NTP function.....	7-3
REF adjustment.....	7-4
Screen Capture function.....	7-4
◇ Setting the Screen Capture function	7-4
◇ Capturing a screen	7-4
◇ Viewing the captured screen	7-4
Entering DTMF code	7-5
Transmitting the DTMF code	7-5
◇ Transmitting a DTMF code.....	7-5
◇ Transmitting a DTMF code (Direct Input).....	7-5
◇ Selecting the DTMF transmit speed	7-6
Share Pictures function	7-6
Home Channel function.....	7-6
◇ Home Channel setting.....	7-6
◇ Home CH Beep function.....	7-6
About “USB SEND/Keying”	7-7
PRESET menu	7-8
◇ Loading the preset memory.....	7-8
◇ Editing the memory contents.....	7-8

7. OTHER FUNCTIONS

Measuring SWR

The transceiver has a high-performance SWR meter. This meter displays a stable measurement in real time, even if the transmit output power varies frequently.

1. Select the RTTY mode.
2. Set the desired frequency band and a frequency in the portion of the band that you use the most.
3. Set the RF POWER.
 - 144 MHz band: 30 W
 - 430 MHz band: 30 W
 - 1200MHz band: 3 W
4. Touch the TX meter several times until the SWR meter is selected.



NOTE: Before transmitting, monitor the operating frequency to make sure you will not cause interference to other stations on the same frequency.

5. Hold down [PTT] on the microphone to transmit, and then read the SWR on the meter.

SWR meter

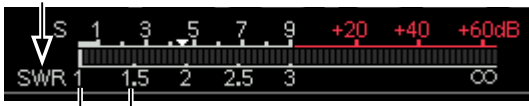

The best match is within this range.
(1.5 or less)

- ① If the SWR meter indicates 1.5 or less, the antenna is matched.
 - ① If the SWR is a high value, adjust your antenna.
6. Release [PTT] to stop transmitting.

Protection function

The transceiver has a 2 step protection function to protect the final power amplifiers in case the antenna SWR becomes high.

The function detects the power amplifier temperature and activates when the temperature becomes too high.

Power down transmission

Reduces the transmission output power.

- "LMT" is displayed to the right of **TX** while transmitting.

TX inhibit

Disables the transmitter.

- **TX** is displayed instead of **TX** while the transmitter is disabled.

If the function is activated, wait until the power amplifier cools down by using the transceiver to only receive.

NOTE: Do not turn OFF the transceiver power when the Protection function is activated. If you do, the cooling fan will stop and it will take longer to cool down.

- You can check the power amplifier temperature with the TEMP gauge in the Multi-function meter.

Selecting the display type and font

You can select between 2 display backgrounds and 2 frequency readout fonts.

◇ Selecting the display background

1. Select the "Display Type" screen.
MENU » **SET > Display > Display Type**
2. Set the background A or B by rotating and then pushing **(MULTI)**.
 - A: Black background (default)
 - B: Blue background
3. To close the DISPLAY screen, push **(EXIT)** several times.

◇ Selecting the display font

1. Select the "Display Font" screen.
MENU » **SET > Display > Display Font**
2. Set the desired display font to "Basic" or "Round" by rotating, and then pushing **(MULTI)**.
 - Basic (Default):
146.520.00
 - Round:
146.520.00
3. To close the DISPLAY screen, push **(EXIT)** several times.

NTP function

The NTP (Network Time Protocol) function synchronizes the internal clock with a time management server.

① To use this function, an internet connection, and default gateway settings are necessary.

◇ Using the NTP Time Synchronize function

Using this function you can manually synchronize the internal clock by accessing a time management server.

1. Display the DATE/TIME screen.

MENU » **SET > Time Set > Date/Time**

2. Touch “<<NTP TIME SYNC>>.”

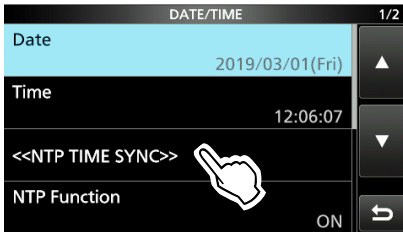

- “NTP Time Sync. Please wait...” is displayed.
- The transceiver starts accessing the NTP server address that is set in the “NTP Server Address” item.

3. When “Time Sync completed.” is displayed, touch [OK].
4. To close the DATE/TIME screen, push **EXIT** several times.

◇ Using the NTP function

By turning ON the NTP function, the transceiver automatically synchronizes the internal clock with the time management server.

① This function is set to ON by default.

① An Internet connection is necessary.

1. Display the DATE/TIME screen.

MENU » **SET > Time Set > Date/Time**

2. Touch “NTP Function.”

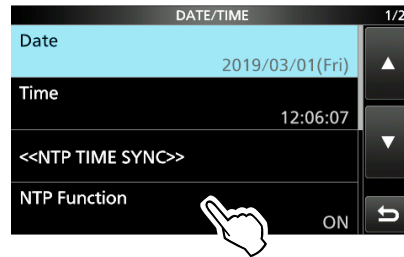

3. Select ON or OFF.
 - When ON is selected, the transceiver starts accessing the NTP server address that is set in the “NTP Server Address” item.
4. To close the DATE/TIME screen, push **EXIT** several times.

7. OTHER FUNCTIONS

REF adjustment

You can perform a rough frequency calibration using the external 10 MHz reference frequency signal.

NOTE: The transceiver has been adjusted and tested at the factory before being shipped. You should not have to re-calibrate it.

1. Apply a highly accurate and stable 10 MHz reference frequency signal to the [REF IN 10MHz] connector.
2. Display the “REF Adjust” screen.
MENU » **SET > Function > REF Adjust**

3. Touch [Sync to REF IN].

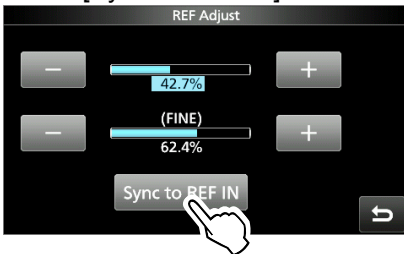

4. Touch [START].

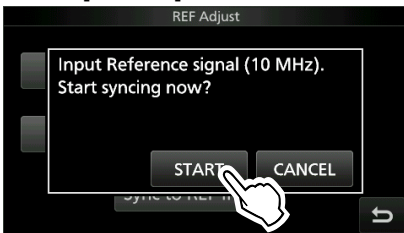

- “Synchronizing. Please wait...” is displayed, and “Synchronized.” is displayed when the Synchronization is completed.
5. Push **EXIT** several times to close the REF Adjust screen.

Information

- While synchronizing, “REF Adjust (Synchronizing to REF IN)” is displayed, and you cannot manually adjust the internal reference frequency.

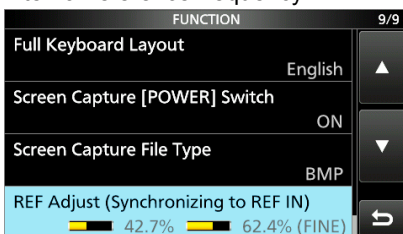

- To cancel the REF IN synchronization, touch [Cancel Sync] in Step 3.
- The REF IN synchronization is not automatically canceled, even if you turn OFF the transceiver, then turn it ON again.

NOTE: Sudden changes of temperature, for example when you turn ON the transceiver, or start transmission, may cause the transceiver to take a longer time to synchronize.

Screen Capture function

You can capture the transceiver display onto an SD card. Most of the screens used in this manual are captured using this function. However, some displays cannot be captured.

Setting the Screen Capture function

1. Open the “Screen Capture [POWER] Switch” screen.
MENU » **SET > Function > Screen Capture [POWER] Switch**
2. Select “ON” by rotating and pushing **MULTI**.

Capturing a screen

1. Select the desired screen to capture.
2. Push **POWER** to capture the screen.
 - The captured screen is saved onto the SD card.

Viewing the captured screen

1. Open the SCREEN CAPTURE VIEW screen.
MENU » **SET > SD Card > Screen Capture View**
 - The capture list is displayed.
 - The latest screen capture is at the top of the list.
2. Touch the desired screen capture to display it.
 - The screen capture is displayed.



- ① While a screen capture is displayed, you can scroll through all the screen captures by rotating **MULTI**.

Other options in the capture list

1. While the capture list is displayed, push **QUICK** to display the QUICK MENU.

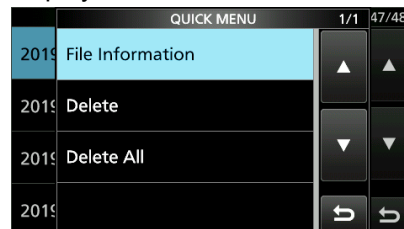

2. Select the desired option.
 - **File Information:** Displays the name, size, and date of the selected screen capture.
 - **Delete:** The confirmation dialog is displayed before deleting the file. Select [YES] to delete or select [NO] to cancel.
 - **Delete All:** The confirmation dialog is displayed before deleting all the files on the list. Select [YES] to delete or select [NO] to cancel.

7. OTHER FUNCTIONS

Entering DTMF code

The transceiver can save up to 16 memories of 24 digit DTMF code.

1. Display the “DTMF” screen.

MENU » **DTMF**

2. Touch [EDIT].

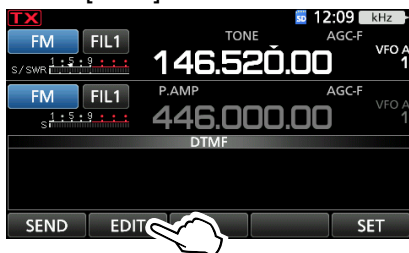

3. Touch the DTMF channel where you want to save a DTMF code. (Example: d0)

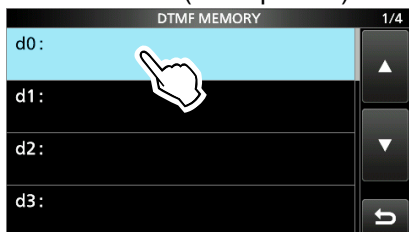

4. Enter a DTMF code, then touch [ENT]. (Example: 123456A)



① See “Keyboard entering and editing” in the BASIC MANUAL for details.

5. Push **EXIT** to close the DTMF MEMORY screen.

Transmitting the DTMF code

◇ Transmitting a DTMF code

1. Display the “DTMF” screen.

MENU » **DTMF**

2. Touch [SEND].

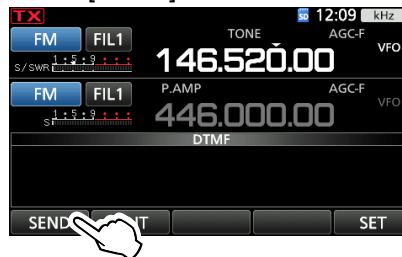

3. Touch the DTMF code you want to transmit. (Example: d0)

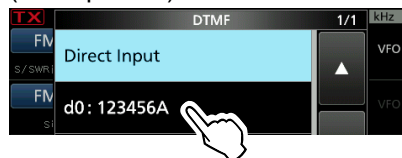

• Transmits the selected DTMF code.

4. Push **EXIT** to close the DTMF screen.

◇ Transmitting a DTMF code (Direct Input)

1. Display the “DTMF” screen.

MENU » **DTMF**

2. Touch [SEND].



3. Touch “Direct Input.”

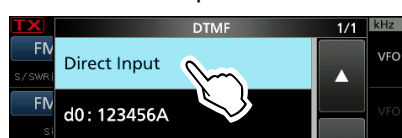

4. Enter a DTMF code, then touch [TX]. (Example: 012345#)



• Transmits the entered DTMF code.

5. Push **EXIT** to close the DTMF screen.

7. OTHER FUNCTIONS

Transmitting the DTMF code

◇ Selecting the DTMF transmit speed

1. Display the “DTMF” screen.

MENU » **DTMF**

2. Touch [SET].



3. Touch “DTMF Speed.”

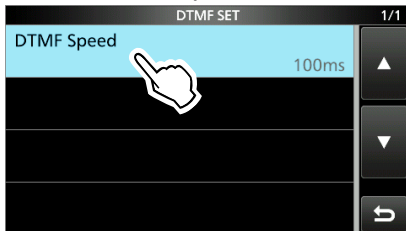

4. Touch to select a transmit speed.



- 100ms: Transmits the DTMF tones at about 100 milliseconds per code.
5 characters per second.
- 200ms: Transmits the DTMF tones at about 200 milliseconds per code.
2.5 characters per second.
- 300ms: Transmits the DTMF tones at about 300 milliseconds per code.
1.6 characters per second.
- 500ms: Transmits the DTMF tones at about 500 milliseconds per code.
1 character per second.

5. Push **EXIT** to close the DTMF SET screen.

Share Pictures function

With this function, you can send a picture from the transceiver, and view a received picture on the transceiver’s display, even if you do not use the software application.

- ① See “About the Share Pictures function” that can be downloaded from the Icom website.

Home Channel function

Home Channels are often-used frequencies you can be preset in the transceiver’s VFO mode, Memory mode, and DR screen.

- ① In the VFO mode and Memory mode, each band memorizes the Home Channel.

◇ Home Channel setting

Example: In the VFO mode

1. Select a mode (VFO or Memory) or the DR screen in which you want to set the Home Channel.
2. Select a frequency, channel, or a repeater to be set as the Home Channel.
① On the DR screen, select “FROM.”
3. Push **QUICK**.
4. Touch “Home CH Set.”



5. Touch “Set Frequency.”

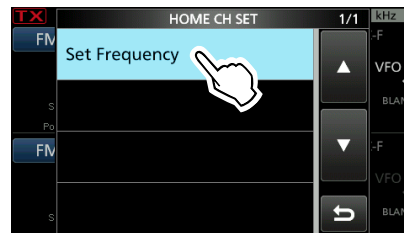

- ① In the Memory mode, touch “Set Channel.” On the DR screen, touch “Set Repeater.”

TIP: Touching “Clear” in Step 5 clears the Home Channel setting.

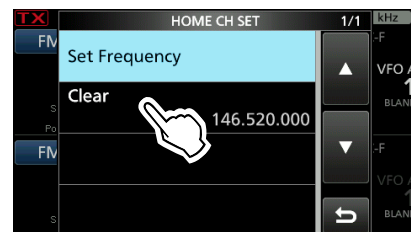

◇ Home CH Beep function

When the set Home Channel is selected, a beep sounds. You can confirm the Home Channel selection without looking at the display.

- ① You can turn OFF the Home CH Beep function.

MENU » **SET > Function > Home CH Beep**

About “USB SEND/Keying”

You can control transmit, receive, and CW/RTTY keying from the PC through the USB port. Select the control port to be used for communication between the transceiver and PC in “USB SEND,” “USB Keying (CW),” and “USB Keying (RTTY)” according to your operating needs.

MENU » SET > Connectors > **USB SEND/Keying**

The IC-9700 has two virtual COM ports, A and B. The transmit and receive control (USB SEND), CW Keying, or RTTY (FSK) Keying signals from the PC are assigned to the DTR/RTS terminals in the virtual port.

① When connecting to a USB port on your PC, the ports are virtually named as USB (A) and USB (B),

TIP: About the “USB SEND/Keying” items

- When you operate RTTY or CW through your PC’s USB port and your IC-9700, you may not be able to send the “SEND” or “Keying” signals until a few seconds after you connect the USB cable.
- When you operate through your PC’s USB port and the IC-9700, and connect a second transceiver to another PC USB port, a short “SEND” or “Keying” signal will be sent from the first transceiver. Therefore, we recommend that you do not connect a second transceiver to a USB port of the same PC. Or, always turn OFF the transceiver power before you connect a USB cable.

USB SEND (Default: OFF)
USB Keying (CW) (Default: OFF)
USB Keying (RTTY) (Default: OFF)

- OFF: Turns OFF the function.
- USB (A) DTR: Uses the DTR terminal on USB (A).
- USB (A) RTS: Uses the RTS terminal on USB (A).
- USB (B) DTR: Uses the DTR terminal on USB (B).
- USB (B) RTS: Uses the RTS terminal on USB (B).

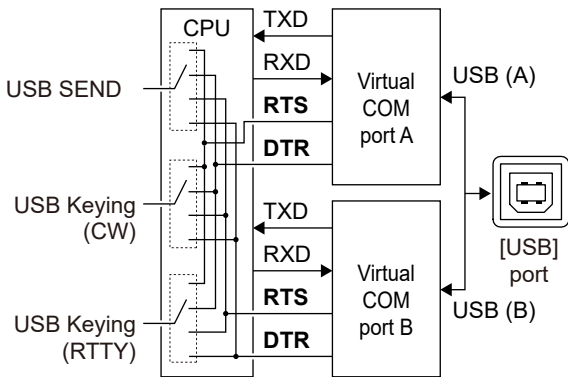

7. OTHER FUNCTIONS

PRESET menu

You can save the combination of the following settings for the data mode to quickly change the settings, depending on your operating needs.

Preset Name	COMP
Mode	SSB TBW
Filter	SSB TX Bandwidth
Filter BW (144M)	USB SEND
Filter BW (430M)	USB Keying (CW)
Filter BW (1200M)	USB Keying (RTTY)
Filter Type	Inhibit Timer at USB Connection
USB Output Select	
USB AF Output Level	CI-V Baud Rate
USB AF SQL	CI-V Address
USB IF Output Level	CI-V Transceive
USB MOD Level	CI-V USB Port
DATA MOD	CI-V USB Baud Rate
SSB-D TX Bandwidth	CI-V USB Echo Back
DATA OFF MOD	

① The transceiver has a total of 5 memories.

◆ Loading the preset memory

① The preset memory contents are loaded into the Main band that is displayed on the upper half of the screen.

1. Push **[MENU]**.
2. Touch ② at the center bottom of the screen.
3. Touch **[PRESET]**.

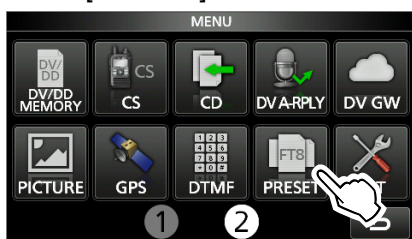

4. Touch the preset memory to load.
 5. Touch **[YES]**.
 - The selected preset memory is loaded, and “In Use” is displayed on the PRESET screen. If you change the transceiver settings, and they do not match the contents of the preset memory, “In Use” disappears.
- ① Touching **[UNLOAD]** returns the transceiver settings to those set before loading the preset memory.

NOTE:

- You can load a memory whose mode is set to “DD” only when the 1200 MHz band is selected.
- You cannot load the preset memory whose “Mode” is checked while:
 - Transmitting in the DV mode.
 - The DR function is ON.
 - The DV Gateway function is ON.
 - The transceiver is in the Satellite mode.
 - Selecting a blank Memory channel in the Memory mode.
- You cannot load a preset memory that is displayed as “(BLANK).”

◆ Editing the memory contents

NOTE: You cannot edit the preset memory that is in use. To edit it, first touch **[UNLOAD]**, and then edit the memory.

1. On the PRESET screen, touch a preset memory to edit for 1 second.
 - Opens the QUICK MENU screen.
2. Touch “Edit the Preset Memory.”
 - ① When touching “Save to the Preset Memory,” all of the contents are set to the current settings before editing.
3. Touch the check box to select whether or not to load the item.
 - “✓” is displayed on the left side of the loading item.
4. Touch the item name, and then touch the option to set.
5. Repeat steps 3 and 4 to edit the preset memory.
6. Touch “<<Write>>.”
7. Touch **[YES]**.

TIP: Depending on your software, you may need to change the “CI-V Address” setting.

For example, you use a software that is not compatible with the IC-9700. In that case, you may be able to use the software by setting “CI-V Address” to a compatible transceiver’s address.

Section 8

GPS OPERATION (BASIC)

Before starting GPS operation.....	8-2
◇ Connecting a GPS receiver.....	8-2
◇ Confirming the GPS signal receiving.....	8-2
Manually input the position data.....	8-3

8. GPS OPERATION (BASIC)

Before starting GPS operation

NOTE: Before using the GPS function, read "IMPORTANT NOTES" about the GPS receiver in the BASIC MANUAL.

You can display your position, and transmit your position data. To use this function, connect a NMEA format compatible external GPS receiver to the transceiver as shown below, or manually enter your position.

- ① You can use the Icom transceiver (Example: ID-31A/E PLUS) as an external GPS receiver.
- ① You can use your Android device as an external GPS receiver using the ST-4002A (free download software).

NOTE: Position data can be transmitted in only the DV mode.

Connecting a GPS receiver

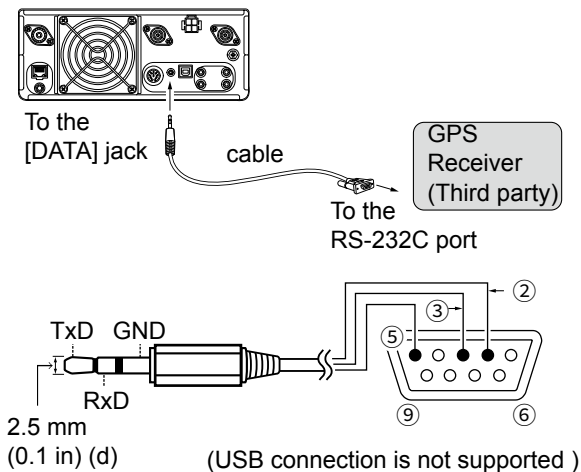

- Connect Pin ② to RxD (Ring).
- Connect Pin ③ to TxD (Tip).
- Connect Pin ⑤ to GND (Sleeve).

Information

- Confirm that "DATA Function" is set to "GPS/Weather."
MENU » SET > Connectors > USB (B)/DATA Function > **DATA Function**
- If you want to output the position data that is received by the GPS receiver, set "GPS Out" to "DATA→USB (B)."
 (Default: OFF)
MENU » SET > Connectors > USB (B)/DATA Function > **GPS Out**
- Set "GPS Receiver Baud Rate," according to your GPS receiver.
MENU » GPS > GPS Set > **GPS Receiver Baud Rate**

Confirming the GPS signal receiving

1. Confirm the GPS receiver is receiving satellite signals.
 The GPS icon blinks when searching for satellites.

The GPS icon stops blinking when the minimum number of satellites needed are found.



- ① It may take only a few seconds to receive, or it may take a few minutes, depending on your operating environment. If you have difficulties receiving, we recommend that you try a different position.
- ① When "GPS Select" is set to "Manual," the icon is not displayed. Set this item to "External GPS."

MENU » GPS > GPS Set > **GPS Select**

2. Push **QUICK**.
3. Touch [GPS Position].

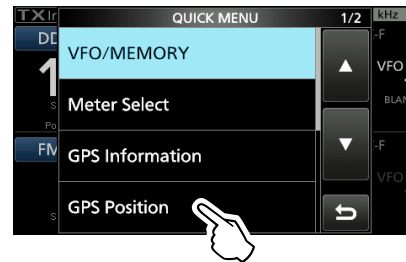

- The GPS POSITION screen opens.
- 4. Rotate **MAIN DIAL**.
 • My screens (MY), received screens (RX), the GPS Memory channel screen (MEM), and the GPS Alarm channel screen (ALM) are displayed.
- 5. To close the GPS POSITION screen, push **EXIT**.

GPS POSITION (MY) screen

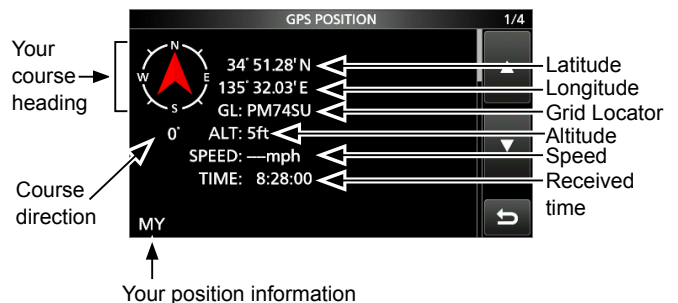

- ① When "GPS Select" is set to "Manual," SPEED, Compass and Compass Direction are not displayed.

8. GPS OPERATION (BASIC)

Manually input the position data

1. Setting the current position

1. Display the MANUAL POSITION screen.

MENU » **GPS > GPS Set > Manual Position**

2. Push **QUICK**.

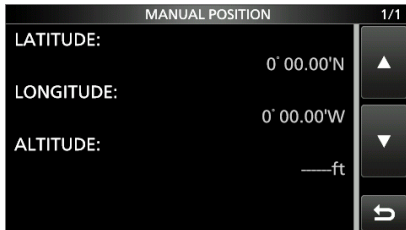

3. Touch [EDIT].

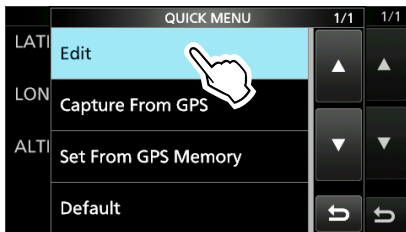

4. Touch [LATITUDE].

5. Enter the Latitude, and then touch [ENT].

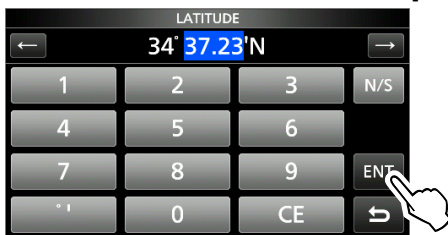

6. Enter the Longitude in the same way.

7. Touch "<<Write>>."

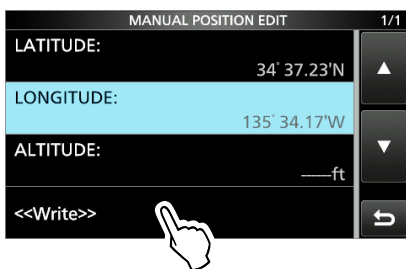

8. Touch [YES].

9. To close the MANUAL POSITION screen, push

EXIT.

TIP: In Step 3, touch "Capture From GPS" to manually update your position with the received GPS data.

2. Setting "GPS Select" to "Manual"

1. Display the "GPS SELECT" screen.

MENU » **GPS > GPS Set > GPS Select**

2. Touch [Manual].

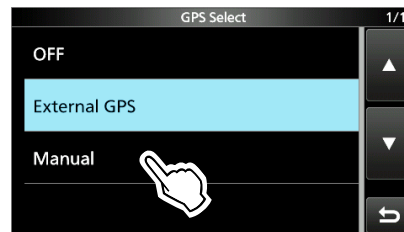

- The manually entered position data is set as your station's position.

3. To close the GPS SET screen, push **EXIT** several times.

GPS TX mode and TX format types	9-2
Difference between older models	9-2
When a received signal contains position data	9-3
Checking your position	9-3
◇ Displaying Position Data	9-3
◇ GPS POSITION screens and their meanings	9-4
◇ About the RX screen	9-5
◇ Setting the display type (MAIN/SUB)	9-6
◇ About the Course	9-6
◇ About the Grid Locator	9-6
◇ Changing the GPS Memory or Alarm	9-7
◇ Changing the Compass Direction.....	9-7
◇ Saving your own or a received station's position.....	9-8
Checking GPS information (Sky view screen).....	9-9
Transmitting D-PRS data.....	9-10
◇ D-PRS	9-10
◇ Operating in the D-PRS mode.....	9-10
◇ Displayed items	9-11
◇ Setting D-PRS Position (Mobile/Base)	9-12
◇ Setting D-PRS Object/Item.....	9-13
◇ Setting D-PRS Weather.....	9-14
◇ Weather station transmission	9-15
◇ Confirming the weather data input	9-15
◇ Application setting	9-15
◇ About the weather data content	9-15
◇ Displaying your position using a mapping software	9-16
Transmitting NMEA data.....	9-18
◇ Setting the GPS data sentence	9-18
◇ Setting a GPS message	9-19
GPS Automatic Transmission.....	9-19
GPS Memory	9-20
◇ Adding a GPS Memory.....	9-20
◇ Entering the GPS Memory group name	9-22
◇ Deleting GPS Memory.....	9-23
◇ Rearranging the display order of the GPS data	9-24
GPS Alarm.....	9-25
◇ Setting the GPS Alarm function to All Memories (all GPS Memories).....	9-26
◇ Setting the GPS Alarm function to RX (a caller station)	9-27
GPS SET	9-28

9. GPS OPERATION (ADVANCED)

GPS TX mode and TX format types

GPS position data has 2 TX modes, D-PRS and NMEA. Moreover, with the D-PRS mode data, 5 position formats. Position (Mobile station/Base station), Object, Item, and Weather, are selectable.

Example: When the caller's TX format is D-PRS Position (Mobile)

MENU » **GPS > GPS Position**

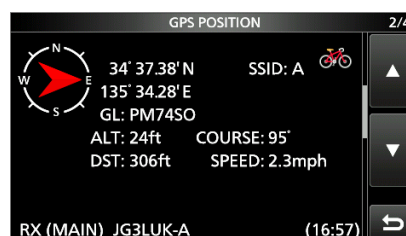

D-PRS	D-PRS is a function that simultaneously sends position data received from an external GPS receiver, using the slow speed data packet space, along with voice.
Position (Mobile)	A station operating from a vehicle, or other position, away from its normal base position.
Position (Base)	A station operating at home or in a building.
Object	Transmitting Object data such as an earthquake information, satellite track information, and so on. An Object contains a time stamp.
Item	Transmitting Item data such as a traffic accident, lighthouse, antenna, or DV access point position, and so on. An Item does not contain a time stamp.
Weather	A station transmitting weather information received from a weather device.
NMEA	A station transmitting position data (NMEA0183) received from an external GPS receiver.

Difference between older models

(As of May 2023)

- The GPS TX mode, “GPS (DV-G)” and “GPS-A (DV-A),” are now called as “NMEA (DV-G)” and “D-PRS (DV-A).”
GPS (DV-G) → NMEA (DV-G)
GPS-A (DV-A) → D-PRS (DV-A)
- For users who have one of the following models:
(ID-800H, IC-91AD/E91, IC-U82, IC-V82, IC-7100, ID-51A/E, ID-31A/E, IC-9100, IC-80AD/E80D, ID-880H/E880, IC-92AD/E92D, IC-2820H/E2820)
When you receive a D-PRS position (Base), Object, Item, or Weather information, their data is not displayed.
- Only the ID-51A/E PLUS, ID-51A/E PLUS2, ID-31A/E PLUS, ID-5100A/E, ID-4100A/E, IC-R30, IC-9700, IC-705, ID-52A/E, and IC-905 can receive Power, Height, Gain, and Directivity data.
- For users who have one of the following models:
(IC-9100, IC-80AD, IC-E80D, ID-880H, ID-E880, IC-92AD, ICE92D, IC-U82, IC-V82)
If you transmit with the Altitude setting ON, the character string is included in a comment on the products that cannot display the altitude.
- Set the GSV sentence to OFF when sending the GPS message to conventional digital transceivers (IC-2820H, IC-E2820, ID-800H, IC-91AD, IC-E91, IC-V82, IC-U82, IC-2200H). The GSV sentence is incompatible with them.
They will not display GPS messages properly if sent as a GSV sentence from the IC-9700.

9. GPS OPERATION (ADVANCED)

When a received signal contains position data

When a received signal contains position data, the caller's position data is displayed in the RX position window.

See the right for details.

Example: When the signal from JG3LUK contains position data.



When you receive the signal, the RX position data is displayed in the RX position window.



After a few seconds, the window disappears.



RX position icon

When the received signal contains position data, the RX position icon is displayed as shown above.

① If you touch the RX position icon, the RX position window is displayed again.

① You can turn OFF the caller's position data indication.

MENU » **SET > Display > RX Position Display**

① You can turn OFF the RX position icon indication.

MENU » **SET > Display > RX Position Indicator**

Checking your position

You can check your current position.

This section is described using received position data.

① The screens are just examples.

◇ Displaying Position Data

1. Push **QUICK** in the standby mode.
2. Touch "GPS Position."
 - The GPS POSITION screen is displayed.
3. Rotate **MAIN DIAL**.
 - My screens (MY), received screens (RX), the GPS Memory channel screen (MEM), and the GPS Alarm channel screen (ALM) are displayed.



The displayed icon depends on the type of screen (MY, RX, MEM, or ALM).

4. To close the GPS POSITION screen, push **EXIT**.

NOTE: Latitude, longitude, and altitude data may differ, depending on your received GPS signal.

TIP:

- If you transmit with the GPS POSITION screen open, the screen is temporarily canceled. To check the position, push **QUICK**, then touch "GPS Position" while transmitting.
- On the MY screen or RX screen, you can enter the displayed position information in a GPS Memory by pushing **QUICK** and touching "GPS Memory."
- See page 9-20 about the GPS Memory function and see page 9-25 about the GPS Alarm function to know more details.

9. GPS OPERATION (ADVANCED)

Checking your position

◇ GPS POSITION screens and their meanings

① Information

- Pushing **QUICK** to change the compass direction. (p. 9-7)
- About the Course (p. 9-6)
- About the Grid Locator (p. 9-6)

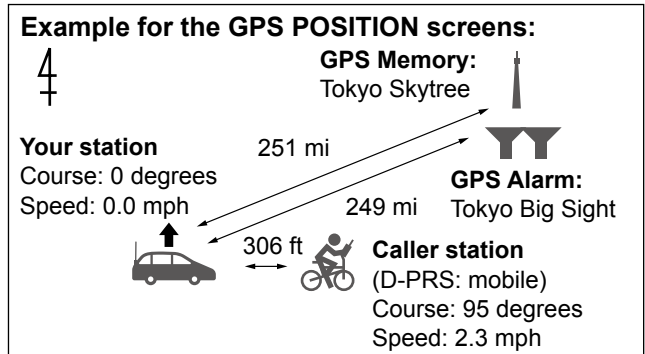

MY screen (Your position information)

When GPS Select is set to "Manual," compass heading and course direction are not displayed. (p. 9-28)

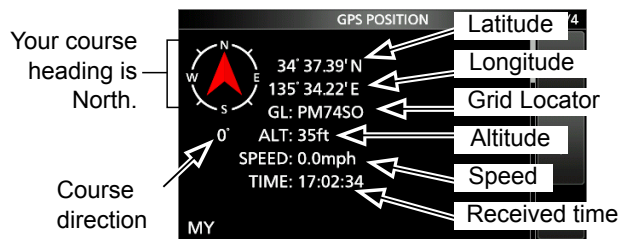

RX screen (Caller's position information)

Depending on the caller's GPS TX Mode and TX format, displayed item's meanings differ, and some data may not be displayed. (p. 9-5)

Example: The caller station's GPS TX Mode is "D-PRS" and its TX format is "Position (Mobile)."

*1 The icon differs, depending on how the signal is received.

- (No icon): The Normal mode (RF)
- TM: The Terminal mode
- MONI: The DV Repeater Monitor function

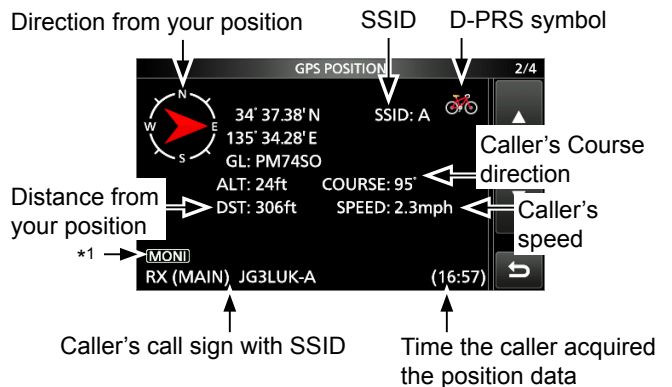

MEM screen (GPS Memory channel's information)

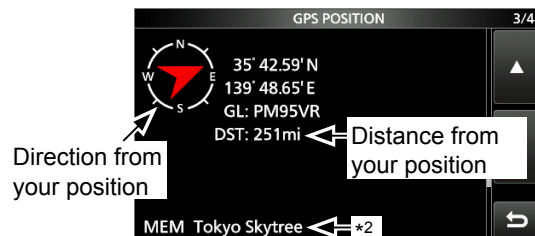

ALM screen (GPS Alarm Memory channel's information)

*2 When a name is not entered in the GPS Memory channel, date and time are displayed instead of the name. In the QUICK MENU window, you can change the GPS Memory or GPS Alarm in the GPS POSITION screen. (p. 9-7)

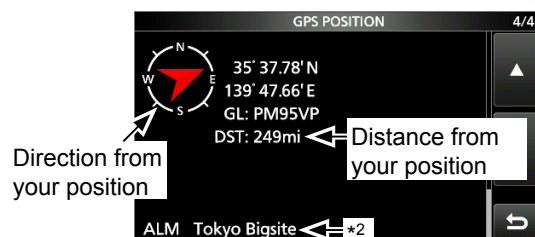

9. GPS OPERATION (ADVANCED)

Checking your position

◇ About the RX screen

TX format:

D-PRS

Position (Mobile)

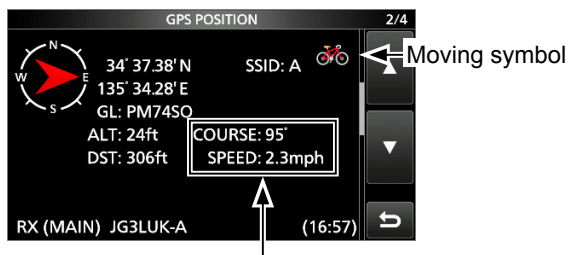

For a mobile station, Course and Speed are displayed.

Position (Base)

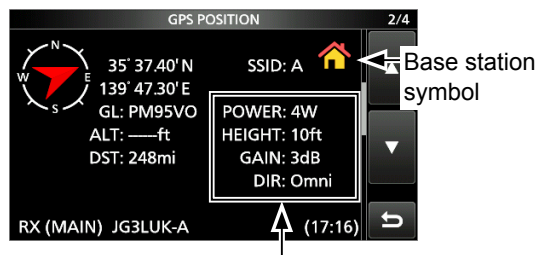

For a base station, Output power, Antenna height, Antenna gain, and Antenna direction are displayed.

Object



Time that the caller sent the Object's data.

Item

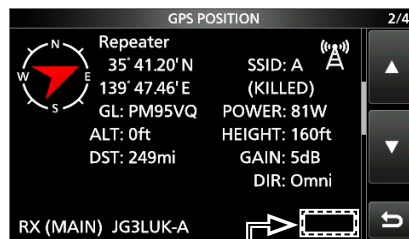

① For an Item station, Time is not displayed.

Weather

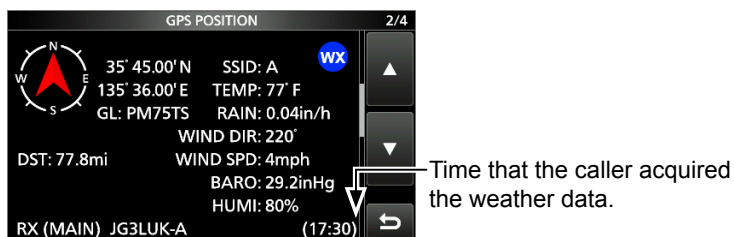

Time that the caller acquired the weather data.

① Call sign is displayed with an SSID.

① When the Object or Item's status is finished, "KILLED" is displayed.

TX format:

NMEA

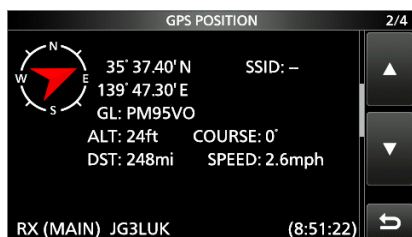

① Symbol or SSID is not displayed when the TX format is NMEA.

9. GPS OPERATION (ADVANCED)

Checking your position

◇ Setting the display type (MAIN/SUB)

You can select the display type for the RX screen.

1. While selecting the RX screen, push **QUICK**.
2. Touch "Display Select(MAIN/SUB)."

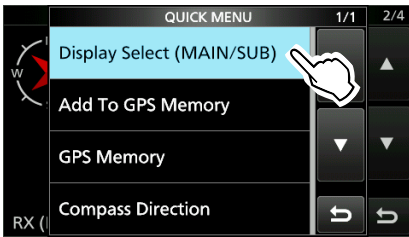

3. Touch the desired option.
 - Latest (MAIN/SUB):
The last received station's position information is displayed.
 - MAIN: The position information of the station received on the MAIN band is displayed.
 - SUB: The position information of the station received on the SUB band is displayed.
- ⓘ When you select "MAIN" or "SUB," "(MAIN)" or "(SUB)" is displayed next to "RX."

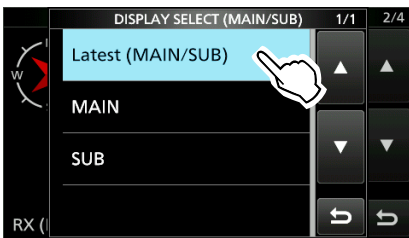

◇ About the Course

The course displayed on the GPS POSITION screens are indicated in degrees.

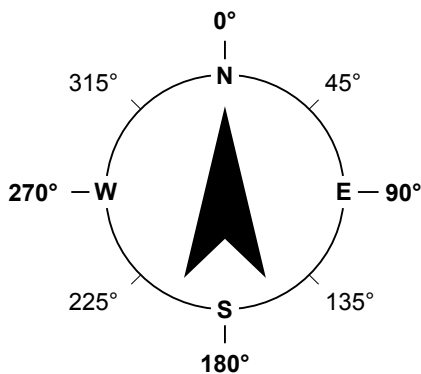

◇ About the Grid Locator

Grid Locator (GL) is a position compressed into a 6 character code, calculated by the longitude and the latitude.

The locator is simply calculated by dividing the earth surface into squares.

It is used to find the area of a transceiver station.

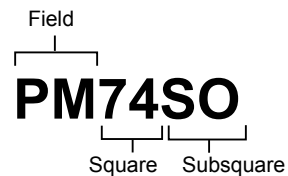
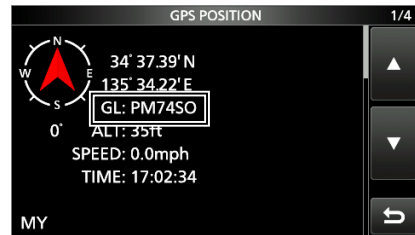

The grid locator map of Japan

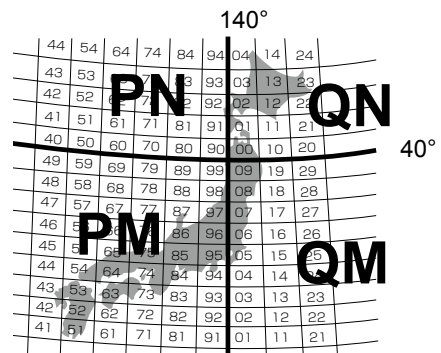

9. GPS OPERATION (ADVANCED)

Checking your position

◇ Changing the GPS Memory or Alarm

You can change the GPS Memory or GPS Alarm in the GPS POSITION screen.

1. While selecting the MEM screen or ALM screen, push **QUICK**.
2. Touch “GPS Memory Select,” or touch “Alarm Select.”

MEM screen

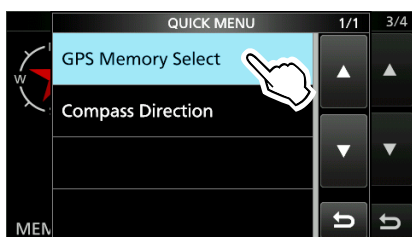

ALM screen

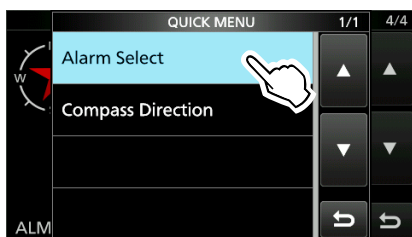

3. Select the GPS Memory or GPS Alarm to display on the GPS POSITION screen.
① Adding or editing a GPS Memory: p. 9-20
① Setting the GPS Alarm: p. 9-25

◇ Changing the Compass Direction

You can set the compass direction to Heading Up, North Up, or South Up.

1. While displaying the GPS POSITION screen, push **QUICK**.
2. Touch “Compass Direction.”

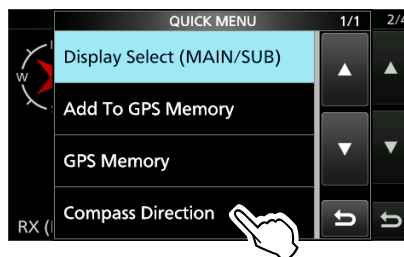

3. Select the compass direction.



Heading Up



The top is always your course direction.

North Up

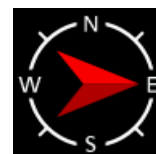

The top is always north.

South Up



The top is always south.

9. GPS OPERATION (ADVANCED)

Checking your position

◇ Saving your own or a received station's position

You can save position of your station and the position of the caller station.

The GPS Memory has a total of 300 channels, and the channels can be assigned into one of 27 banks, A ~ Z, and (No Group).

1. Select the screen that you want to save.
 - ① To save your own position: MY screen
 - ① To save a received position: RX screen
2. Push **QUICK**.
3. Touch "Add To GPS Memory."
 - ① See pages 9-20 ~ 9-22 for entering details.

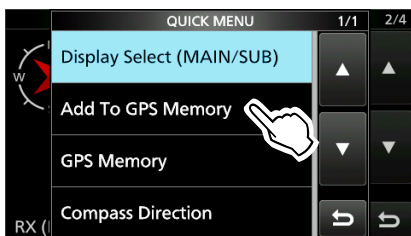

4. Touch "<<Add Write>>."
 - ① To select the destination group to be saved, touch "GROUP."

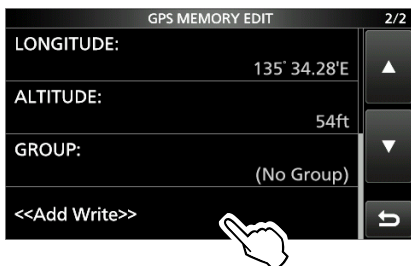

5. Touch [YES].
 - Saves the data in the GPS Memory, then returns to the GPS POSITION screen.
6. To close the GPS POSITION screen, push **EXIT**.

TIP: The position is saved in the selected group with the "GROUP" item.

MENU » **GPS > GPS Memory**

Checking GPS information (Sky view screen)

This screen is used to view GPS satellite information when the GPS icon does not stop blinking for a long time.

The GPS Information displays the quantity, signal power, and position of the GPS satellites.

The sky view screen displays the position of GPS satellites. The screen also displays the direction, elevation angle, satellite numbers, and their receiving signal strength status.

1. Push **QUICK**.
2. Touch "GPS Information."

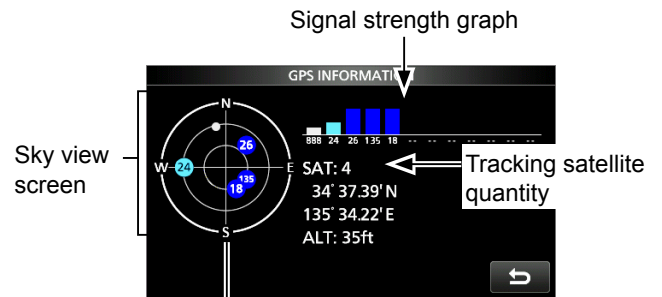
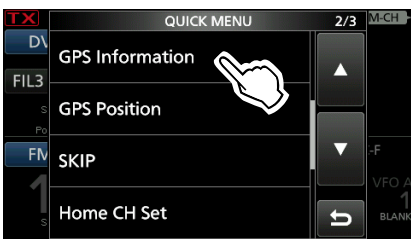

About the display

- : Untracking satellite.
- : Tracking satellite with a weak signal, shown by the satellite number.
- : Tracking satellite with a strong signal, shown by the satellite number.
- SAT: The quantity of tracking satellites.
- Altitude: The altitude of your station. The altitude is only displayed when 4 or more satellites are tracked. When 3 or less satellites are tracked, "-----ft" is displayed.
- Longitude/Latitude: Longitude and Latitude of your station.
- Signal strength graph:
 - Signal strength of the satellites
 - : Untracking satellite
 - : Tracking satellite with a weak signal
 - : Tracking satellite with a strong signal

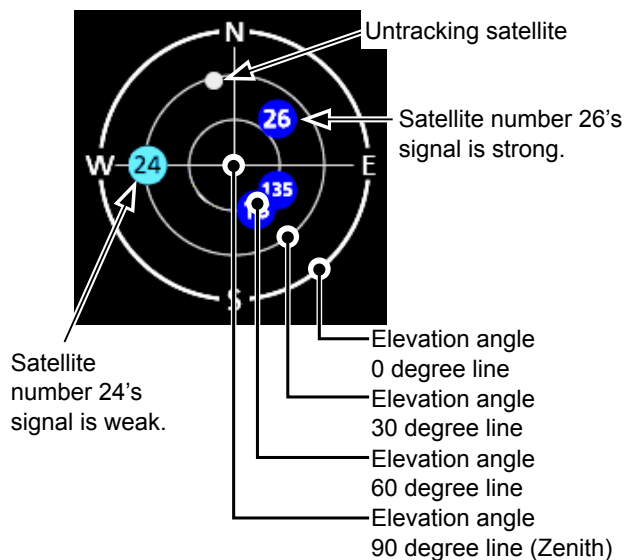

3. To close the GPS INFORMATION screen, push **EXIT**.

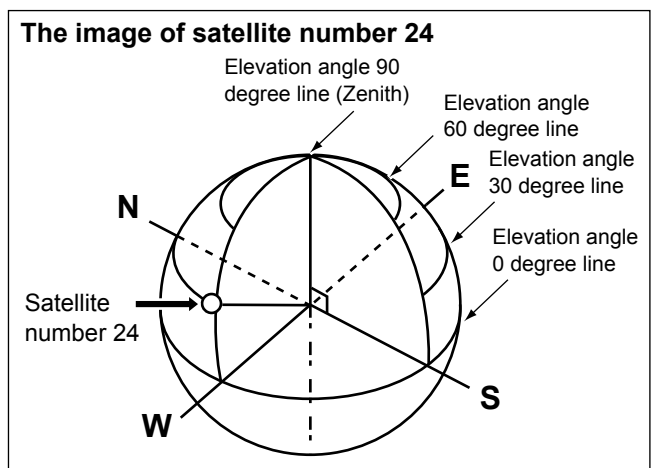

Transmitting D-PRS data

When D-PRS is selected as the GPS TX mode, you can transmit D-PRS data.

When operating in the D-PRS mode, the following codes are transmitted to the PC.

D-PRS code is based on APRS® code.

(APRS®: Automatic Packet Reporting System)

◇ D-PRS

D-STAR Packet Reporting System (D-PRS) is a mode that simultaneously sends position data received from an external GPS receiver, using the slow speed data packet space, along with voice audio in the DV mode. In the Analog mode, you can transmit or receive only voice audio or data at one time. However a D-PRS capable radio can transmit or receive message data or GPS position data at the same time voice is being transmitted or received.

I-GATE is required to send position data to the APRS server.

The image of D-PRS

<Using a Repeater>

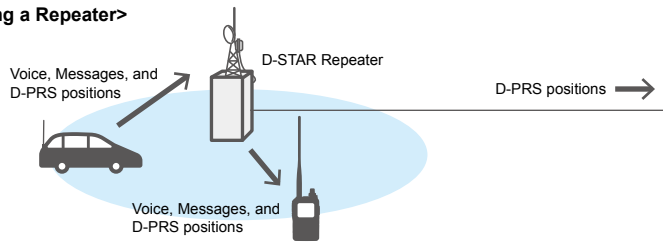

<Simplex>

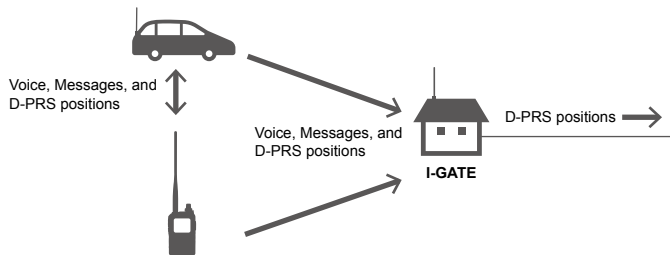

NOTE:

- If **GPS select** is set to "Manual," the manually entered position data in Manual Position is change to the D-PRS data format to transmit.

MENU » **GPS > GPS Set > GPS Select**

- Note that if **GPS Auto TX** is set to any other setting than "OFF," the data is transmitted according to the set time.

MENU » **GPS > GPS Auto TX**

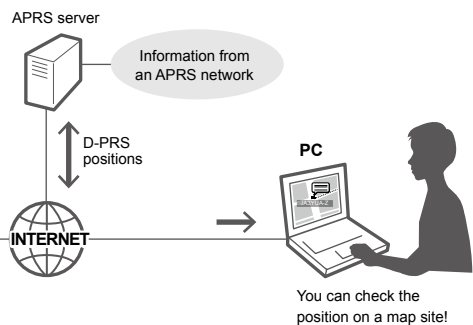

◇ Operating in the D-PRS mode

To transmit in D-PRS, follow the steps below, and for more details, see the pages listed along with the steps.

1. "MY" (Your own call sign) entering. (p. 9-3)
2. Receiving GPS data. (p. 7-1)
3. Set GPS TX mode to "D-PRS." (p. 8-3)
4. Set TX information.

① You must set **SSID** and **Symbol**.

MENU » **GPS > GPS TX Mode > D-PRS**



Complete! (You can transmit in the D-PRS mode.)

TIP: In the D-PRS mode, you can transmit earthquake or weather information, in addition to position data.

MENU » **GPS > GPS TX Mode > D-PRS > TX Format**

TX format of D-PRS

- Position (Mobile/Base):
Used to transmit position data.
- Object: Used to transmit specific position data. (Contains a time stamp.)
- Item: Used to transmit specific position data. (Does not contain a time stamp.)
- Weather: Used to transmit weather information.

9. GPS OPERATION (ADVANCED)

Transmitting D-PRS data

◇ Displayed items

Depending on the TX format, the setting items and displayed order of the items differ.

	D-PRS								
	Position		Object			Item			Weather
	Mobile	Base	Data extension: OFF	Data extension: Course/Speed	Data extension: Power/Height/Gain/Directivity	Data extension: OFF	Data extension: Course/Speed	Data extension: Power/Height/Gain/Directivity	
Unproto Address	✓	✓	✓	✓	✓	✓	✓	✓	
Comment	✓	✓	✓	✓	✓	✓	✓	✓	✓
Altitude	✓	✓							
Object Name/Item Name			✓	✓	✓	✓	✓	✓	
Data Type			✓	✓	✓	✓	✓	✓	
Position information (Latitude/Longitude/Altitude)			✓	✓	✓	✓	✓	✓	
Data Extension	✓	✓	✓	✓	✓	✓	✓	✓	
Course				✓			✓		
Speed				✓			✓		
Power		✓			✓			✓	
Height		✓			✓			✓	
Gain		✓			✓			✓	
Directivity		✓			✓			✓	
Symbol	✓	✓	✓	✓	✓	✓	✓	✓	✓
SSID	✓	✓	✓	✓	✓	✓	✓	✓	✓
Time stamp	✓	✓	✓	✓	✓				✓

✓: Displayed

9. GPS OPERATION (ADVANCED)

Transmitting D-PRS data

◇ Setting D-PRS Position (Mobile/Base)

Set to transmit as a D-PRS Position (Mobile/Base).

① See page 9-2 for details.

1. Setting the GPS TX Mode to D-PRS

MENU » **GPS > GPS TX Mode > D-PRS**

2. Checking the Unproto Address

You should use the default address, and editing is not recommended.

3. Setting the TX format to “Position”

4. Setting the Symbol

Select the Symbol that indicates your operating situation.

① See page 9-28 to directly enter the Symbol.

5. Setting the SSID

To assist in identifying your station’s type, add the APRS® (Automatic Packet Reporting System) based SSID after the D-PRS data call sign. (p. 9-29)

6. Entering a comment

Enter a comment, and transmit it with the D-PRS position data.

① The number of characters you can enter differs, depending on the data extension and altitude settings. (p. 9-29)

1. Touch “Comment.”
2. Push **QUICK**.
3. Touch “Edit.”
4. Enter a comment.
5. After entering, touch [ENT].
6. Push **EXIT**.

7. Setting the Time Stamp

Set the Time Stamp function to transmit the received time data in UTC (Universal Time Coordinated) time. (p. 9-30)

8. Setting the Altitude

Set the altitude data acquired from the GPS receiver. (p. 9-30)

NOTE: If you transmit with the altitude setting ON, the character string is included in a comment on the products that cannot display the altitude.

9. Setting the Data Extension

Set the data extension of your station’s information.

- ① Set the Data Extension to “Course/Speed” to transmit as a mobile station.
- ① Set the Data Extension to “Power/Height/Gain/Directivity” to transmit as a base station.

When you set the Data Extension to “Power/Height/Gain/Directivity”:

9-1. Setting the TX power

Select the TX power level of the base station, to transmit along with the position data.

9-2. Setting the antenna height

Select the height of the base station’s antenna, to transmit along with the position data.

9-3. Setting the antenna gain

Select the gain of the base station’s antenna, to transmit along with the position data.

9-4. Setting the antenna directivity

Select the direction the base station’s antenna was pointing, to transmit along with the position data.

10. Exiting the POSITION screen

To close the POSITION screen, push **EXIT** several times.

- Returns to the standby screen, then **DV 1** is displayed.

9. GPS OPERATION (ADVANCED)

Transmitting D-PRS data

◇ Setting D-PRS Object/Item

Set to transmit as a D-PRS Object or Item.

① See page 9-2 for details.

1. Setting the GPS TX Mode to D-PRS

MENU » **GPS > GPS TX Mode > D-PRS**

2. Checking the Unproto Address

You should use the default address, and editing is not recommended.

3. Setting the TX format to “Object” or “Item”

4. Entering Object name or Item name

Enter an Object or Item name, such as an event information or location.

5. Setting Data type

Set the Object or Item’s status.

① For example, if you want to transmit finished event information as an Object, set the Date type to “Killed Object.”

6. Setting the Symbol

Select a symbol that indicates an Object or Item.

① See page 9-28 to directly enter the Symbol.

7. Entering a comment

Enter a comment to transmit as an Object or Item.

① The number of characters you can enter differs, depending on the data extension and altitude settings. (pp. 9-31, 9-33)

1. Touch “Comment.”
2. Push **QUICK**.
3. Touch “Edit.”
4. Enter a comment.
① See “Keyboard entering and editing” in the BASIC MANUAL for details.
5. After entering, touch [ENT].
6. Push **EXIT**.

8. Setting the Position

Set the position data of an Object or Item.

① For example, if you want to transmit traffic accident information as an Item, set the location where the accident has happened.

If the position data is entered in the GPS memory, you can easily set the position data from the memory.

9. Setting the Data Extension

Set the data extension of an Object or Item’s information.

- ① Set the Data Extension to “Course/Speed” to transmit as a mobile station.
- ① Set the Data Extension to “Power/Height/Gain/Directivity” to transmit as a base station.

When you set the Data Extension to “Course/Speed”:

9-1. Setting the Course

Set the Object or Item’s course when the station moves.

9-2. Setting the Speed

Set the Object or Item’s speed.

When you set the Data Extension to “Power/Height/Gain/Directivity”:

9-3. Setting the TX power

Select the TX power level of the Object or Item if the station is a repeater, node, access point, and so on and an antenna is installed.

9-4. Setting the antenna height

Select the height of the Object or Item’s antenna.

9-5. Setting the antenna gain

Select the gain of the Object or Item antenna.

9-6. Setting the antenna directivity

Select the direction the base Object or Item’s antenna was pointing.

10. Setting the SSID

To assist in identifying a station’s type, the displayed APRS® (Automatic Packet Reporting System) based SSID is added after the D-PRS data call sign.

The way to add SSID’s differs, depending on whether you enter a space in your call signs or not.

Transmitting D-PRS data

◇ Setting D-PRS Object/Item

11. Setting the Time Stamp

① This item is displayed when the TX format is "Object."
Set the time stamp function to transmit the Object's time data in UTC (Universal Time Coordinated) time.

12. Exiting the OBJECT or ITEM screen

To close the OBJECT or ITEM screen, push **EXIT** several times.

- Returns to the standby screen, then **DV** is displayed.

◇ Setting D-PRS Weather

Set to transmit as a D-PRS Weather station.

① See page 9-15 for details.

1. Setting the GPS TX Mode to D-PRS

MENU » **GPS > GPS TX Mode > D-PRS**

2. Checking the Unproto Address

You should use the default address, and editing is not recommended.

3. Setting the TX format to "Weather"

4. Setting the Symbol

Select a symbol that indicates the weather station.

① See page 9-28 to directly enter the Symbol.

5. Setting the SSID

To assist in identifying a station's type, the displayed APRS® (Automatic Packet Reporting System) based SSID is added after the D-PRS data call sign.

The way to add SSID's differs, depending on whether you enter a space in your call signs or not.

6. Entering a comment

Enter a comment to transmit as a D-PRS Weather station.

1. Touch "Comment."
2. Push **QUICK**.
3. Touch "Edit."
4. Enter a comment.
① See "Keyboard entering and editing" in the BASIC MANUAL for details.
5. After entering, touch [ENT].
6. Push **EXIT**.

7. Setting the Time Stamp

Set the time stamp function to transmit the received time data in UTC (Universal Time Coordinated) time.

8. Exiting the WEATHER screen

To close the WEATHER screen, push **EXIT** several times.

- Returns to the standby screen, then **DV** is displayed.

9. GPS OPERATION (ADVANCED)

Transmitting D-PRS data

◇ Weather station transmission

When you transmit as a weather station, you should set the weather station's settings, and input the weather data to the [DATA] jack.

You can input the weather data from a third party's weather device by converting it to the APRS weather format in your PC or microcomputer.

After completing the weather station's settings, and inputting the weather data, you can transmit as a weather station.

NOTE: If the weather data is not input to the [DATA] jack, you cannot transmit as a weather station.

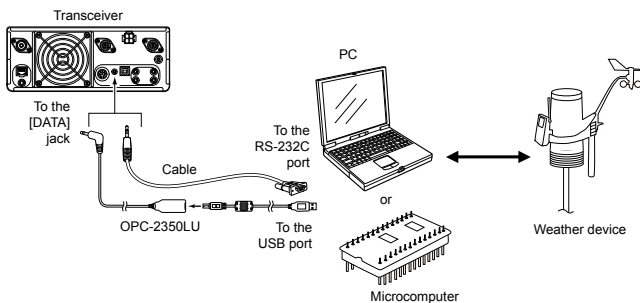

Terminal information

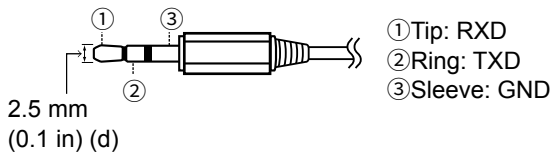

◇ Confirming the weather data input

You can confirm whether or not the weather data is input to the [DATA] jack.

1. Set **GPS TX Mode** to "D-PRS," and **TX format** to "Weather." (p. 9-28)
 2. On the standby screen, push **QUICK**.
 3. Touch "Weather Information."
 - Displays the WEATHER INFORMATION screen as shown below if the weather data is input to the [DATA] jack.
- ① When the weather information is displayed, you can transmit as a weather station. If "-" is displayed on the screen, the weather data does not input to the [DATA] jack. In that case, check the input data settings.

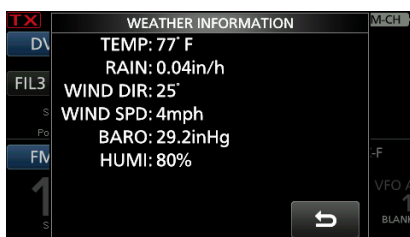

◇ Application setting

Configure the communication software as follows.

- Port: The COM port number that is used by the IC-9700.*1
- Baud rate: 4800/9600 bps*2
- Data: 8 bit
- Parity: none
- Start: 1 bit
- Stop: 1 bit
- Flow control: none

*1 Depending on the PC environment, the COM port number used by the IC-9700 may be higher than 5. In that case, use an application that can set it to higher than 5.

*2 Set the baud rate in **DV Data/GPS Out Baud Rate**.

MENU » SET > Connectors > USB (B)/DATA Function > DV Data/GPS Out Baud Rate

◇ About the weather data content

The weather data should be input according to the format (based on the APRS® Weather Data) as shown below.

Example:

220/004 g005 t077 r000 p000 P000 h50 b09900 End code
 1 2 3 4 5 6 7 8 9

No.	Item	Value	Unit
1	Wind direction	000 to 360	°
2	Wind speed	000 to 999	mph
3	Gust speed	g000 to g999	mph
4	Temperature	t-99 to t-01, t000 to t999	°F
5	Rainfall	r000 to r999*1	inch
6	Rainfall (24 Hours)	p000 to p999*1	inch
7	Rainfall (Midnight)	P000 to P999*1	inch
8	Humidity	h00, h01 to h99 (h00 indicates 100%.)	%
9	Barometric pressure	b00000 to b99999*2	hPa, mb

*1 The last two digits indicate the two decimal place.

*2 The last digit indicates the one decimal place.

- ① If you have no data, enter a space or "." (period) instead of a number.
 (Example: ".../...g...t077r000p...P...h50b.....")
- ② Enter <CR>, <LF> or <CR><LF> for an end code.

9. GPS OPERATION (ADVANCED)

Transmitting D-PRS data

◇ Displaying your position using a mapping software

If you transmit to an I-GATE station, and then enter the call sign information on the Internet map website, the selected symbol is displayed.

You can check on the Internet!



Example: Check your position on the APRS.fi site.

1. Display a free APRS® related map site on the Internet.
① Example: <http://aprs.fi/>
2. Enter your call sign in the “Track callsign” field.
3. Click <Search>.
 - The icon (D-PRS symbol) is displayed on the map site.

Enter your call sign, and then click <Search>.



The screenshot shows the APRS.fi website interface. At the top, there is a search bar labeled "Track callsign: Clear" with a "Search ?" button. Below the search bar, there is a "Track callsign: Clear" input field and another "Search ?" button. The main part of the page is a map of Osaka, Japan, with various ward boundaries and landmarks. A call sign is entered in the search bar, and a red symbol representing the D-PRS station is visible on the map. The map is centered on the Nishi Ward area. The website also displays various navigation and information options on the right side, including "aprs.fi - Login", "aprs.fi - Station info", "aprs.fi - Raw packets", "aprs.fi - Status packets - Beacon packets", "aprs.fi - APRS/CWOP weather - Telemetry", "aprs.fi - Messages - Bulletin board", "aprs.fi - Profile browsing", "aprs.fi - Google Earth KML ?", "aprs.fi - Data export tool", and "aprs.fi - Preferences - My account".

←Your symbol and your call sign

9. GPS OPERATION (ADVANCED)

Transmitting D-PRS data

TIP:

D-PRS data content

D-PRS data content are shown below.

◇Position (Mobile)

(e.g.) JA3YUA-A>API970,DSTAR*:/002338h3437.38N/13534.29E>090/002/A=000012|C-9700 OP.SATOH
 ① ② ③ ④ ⑦ ⑧ ⑨ ⑩ ⑨ ⑪ ⑬ ⑭

◇Position (Base)

(e.g.) JA3YUA-A>API970,DSTAR*:/002338h3437.38N/13534.29E-PHG5132OP.SATOH
 ① ② ③ ④ ⑦ ⑧ ⑨ ⑩ ⑨ ⑫ ⑭

◇Object

(e.g.) JA3YUA-A>API970,DSTAR*:/HAM FESTA*012345z3437.38N\13534.29Eh2019.02.01 am10-pm4
 ① ② ③ ④ ⑤ ⑥ ⑦ ⑧ ⑨ ⑩ ⑨ ⑭

◇Item

(e.g.) JA3YUA-A>API970,DSTAR*:/REPEATER!3454.00N/13536.00ErPHG5132439.39MHz DV RPT JP3YHH A
 ① ② ③ ④ ⑤ ⑥ ⑧ ⑨ ⑩ ⑨ ⑫ ⑭

◇Weather

(e.g.) JA3YUA-A>API970,DSTAR*:/012345z3454.00N/13536.00E_220/004g005t077r000p000P000h50b09900
 ① ② ③ ④ ⑦ ⑧ ⑨ ⑩ ⑨ ⑮ ⑯ ⑰ ⑱ ⑲ ⑳ ㉑ ㉒

- ① Call sign
- ② SSID
- ③ Unproto Address
- ④ D-PRS Data type
/ Position with time stamp
! Position without time stamp
; Object
) Item
- ⑤ Object Name/Item Name
- ⑥ Data Type
* Live Object
! Live Item
_ Killed Object/Killed Item
- ⑦ Time Stamp (UTC)
h Hour Minute Second
z Day Hour Minute
- ⑧ Latitude
- ⑨ Symbol
- ⑩ Longitude
- ⑪ Data Extension (Course/Speed)
Course:0 ~ 360°
Speed:0 ~ 999 knots

⑫ Data Extension(PHG codes)

PHG codes definitions

	0	1	2	3	4	5	6	7	8	9	
First: Power	0	1	4	9	16	25	36	49	64	81	(W)
Second: Height	10	20	40	80	160	320	640	1280	2560	5120	(feet)
Third: Gain	0	1	2	3	4	5	6	7	8	9	(dB)
Fourth: Directivity	omni	45°NE	90°E	135°SE	180°S	225°SW	270°W	315°NW	360°N	-	-

- ⑬ Altitude
-99999 ~ 999999 feet
- ⑭ Comment
- ⑮ Wind direction/Wind speed
Wind direction:0 ~ 360°
Wind speed: 0 ~ 999 mph
- ⑯ Gust speed
0 ~ 999 mph
- ⑰ Temperature
-99 ~ 999°F
- ⑱ Rainfall
0.00 ~ 9.99 inch
- ⑲ Rainfall (24 Hours)
0.00 ~ 9.99 inch
- ⑳ Rainfall (Midnight)
0.00 ~ 9.99 inch
- ㉑ Humidity
1 ~ 99%, 00=100%
- ㉒ Barometric pressure
0.0 ~ 9999.9 hPa

Transmitting NMEA data

Set a GPS sentence to transmit GPS data in the DV mode.

◆ Setting the GPS data sentence

1. Open the NMEA SET screen.

MENU » **GPS > GPS TX Mode > NMEA**

2. Touch "GPS Sentence."

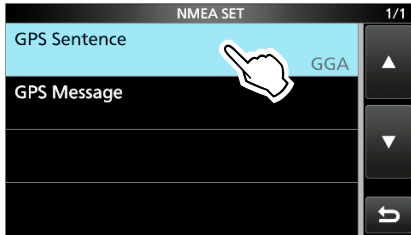

3. Select the GPS sentence.

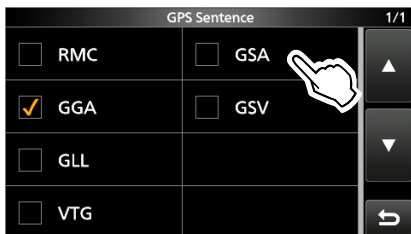

- Displays "✓" when the sentence is set to ON.
 - ① The selectable GPS sentences are RMC, GGA, GLL, VTG, GSA, and GSV. The GGA sentence is set to ON as the default GPS sentence.
 - ① Pushing **QUICK** and touching "Default" returns to the default setting.
4. Repeat step 3 to set the GPS sentence.
- ① Up to 4 GPS sentences can be set at a time.
5. To close the "GPS Sentence" screen, push **EXIT** several times.
- Returns to the standby screen, then **DV** is displayed.

NOTE:

- Set **GSV Sentence** to "OFF" when sending the GPS message to a conventional digital transceivers.
- If **GPS Select** is set to "Manual," the transceiver automatically sets the NMEA sentence, and transmits it along with the manually entered position data in Manual Position.

MENU » **GPS > GPS Set > GPS Select**

MENU » **GPS > GPS Set > Manual Position**

- Note that if **GPS Auto TX** is set to any other option than "OFF," data is automatically transmitted according to the set time.

MENU » **GPS > GPS Auto TX**

① If **GPS Select** is set to "OFF" or "Manual," the GPS Automatic Transmission function is not activated.

Contents of GPS sentence

Sentence	Lon/Lat	Alt	UTC	Date (UTC)	Status	2D /3D	COG (True)	SOG (knot)	Others
RMC	✓		✓	✓	✓		✓	✓	Magnetic variation, Mode Indicator
GGA	✓	✓	✓		✓				Number of satellites in use, HDOP, Geoidal separation, Age of Differential GPS data, Differential reference station ID
GLL	✓		✓		✓				Mode Indicator
VTG							✓	✓	COG (Magnetic north), SOG (km/h), Mode Indicator
GSA					✓	✓			PRN number of satellites used in solution, PDOP, HDOP, VDOP
GSV									Total number of sentences, Sentence number, Total number of satellites in view, Satellite information (ID, Elevation, Azimuth, S/N)

9. GPS OPERATION (ADVANCED)

Transmitting NMEA data

◇ Setting a GPS message

Enter a GPS message to be transmitted with the position data.

Example: Entering “Japan TOM”

1. Open the NMEA SET screen.

MENU » **GPS > GPS TX Mode > NMEA**

2. Touch “GPS Message.”

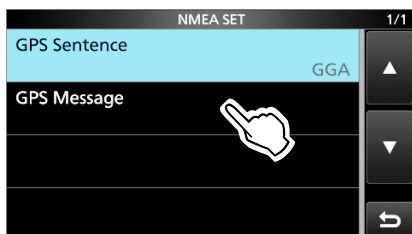

3. Touch [EDIT].



4. Enter a GPS message of up to 20 characters.
5. After entering, touch [ENT].



6. To close the “GPS Message” screen, push **EXIT** several times.

GPS Automatic Transmission

NOTE:

- Use the GPS Automatic Transmission function in only the Simplex mode.
- Using the function through a Repeater may interfere with other communications.

You can set the GPS Automatic Transmission function in the following menu.

MENU » **GPS > GPS Auto TX**

If you set this function, GPS data is automatically transmitted according to the set time.

- ① This function is not activated if your call sign (MY) is not entered in the transceiver.
- ① If **GPS Select** is set to “OFF” or “Manual,” this function is not activated.

MENU » **GPS > GPS Set > GPS Select**

GPS Memory

You can add GPS data to GPS Memory.
You can add your own position, other station's position, or any positions that are manually entered.

You can save the GPS Memory up to 300 channels, and conveniently saved in up to 27 groups, from A ~ Z and "(No Group)." The A to Z groups can also be named.

◇ Adding a GPS Memory

Example: Add "HOME" into (No Group)

1. Adding a GPS Memory and entering the edit mode

1. Open the GPS MEMORY screen.

MENU » **GPS > GPS Memory**

2. Touch "(No Group)."

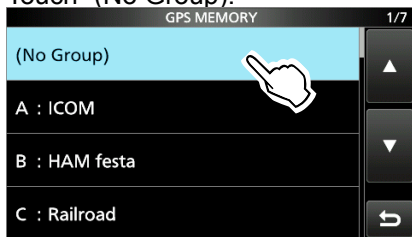

3. Push **QUICK**.
4. Touch "Add."
 - The GPS MEMORY EDIT screen is displayed.

TIP: To edit the previously saved GPS Memory, touch "Edit" in step 4. You can enter the content in the same way as described above.

2. Entering a GPS Memory name

1. Touch "NAME."
2. Enter a GPS Memory name of up to 16 characters. (Example: HOME)
3. After entering, touch [ENT].

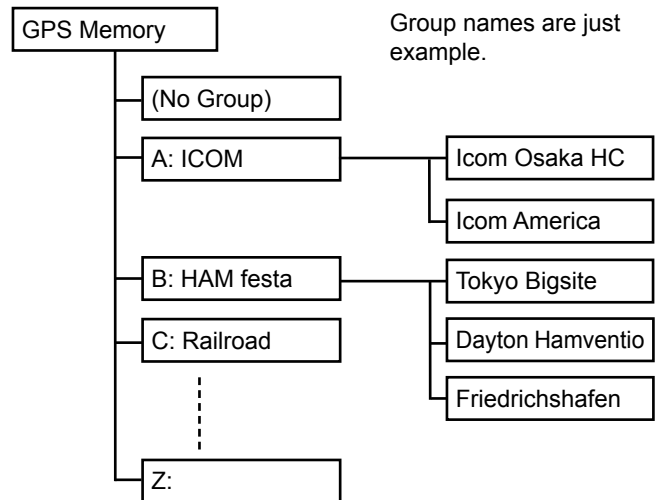
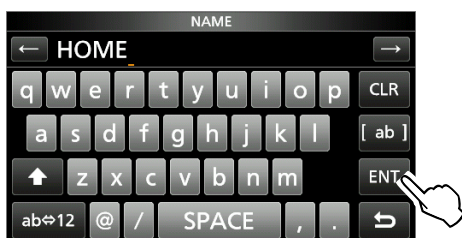

3. Entering the GPS Memory date

1. Touch "DATE."
2. Touch a digit to enter.
3. Touch [+] and [-].
① Set to between 2000/01/02 and 2099/12/30.
4. Repeat step 2 and 3 to enter the date.

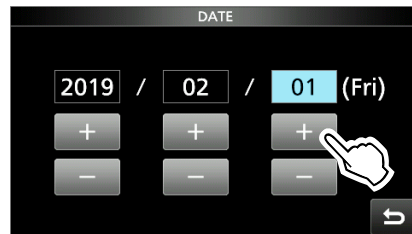

5. After entering, push **EXIT**.

4. Entering the GPS Memory time

1. Touch "TIME."
2. Touch a digit to enter.
3. Touch [+] and [-].
① Set to between 00:00:00 and 23:59:59.
4. Repeat step 2 and 3 to enter the time.

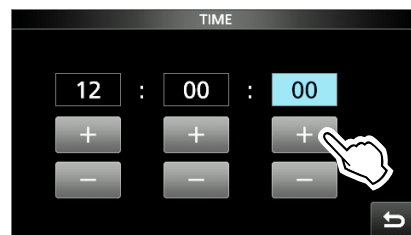

5. After entering, push **EXIT**.

9. GPS OPERATION (ADVANCED)

GPS Memory

◇ Adding a GPS Memory

5. Entering the GPS Memory latitude

1. Touch "LATITUDE."
2. Touch a digit to enter.
3. Enter the latitude.
 - ① Set to between 0°00.00' to 90°00.00'.
 - ① You can change the unit.

MENU » SET > Display > Display Unit > Latitude/Longitude

4. Repeat steps 2 and 3 to enter the latitude.



5. Touch [N/S] to set to a north latitude (N) or a south latitude (S).
6. After entering, touch [ENT].

6. Entering the GPS Memory longitude

1. Touch "LONGITUDE."
2. Touch a digit to enter.
3. Enter the longitude.
 - ① Set to between 0°00.00' to 180°00.00'.
 - ① You can change the unit.

MENU » SET > Display > Display Unit > Latitude/Longitude

4. Repeat steps 2 and 3 to enter the longitude.



5. Touch [E/W] to set to an east longitude (E) or a west longitude (W).
6. After entering, touch [ENT].

7. Entering the GPS Memory altitude

1. Touch "ALTITUDE."
2. Touch [+/-] to set to plus or minus.
3. Enter the altitude.
 - ① Set to between -32808 and +32808 feet.



4. After entering, touch [ENT].

8. Selecting a GPS Memory group

1. Touch "GROUP."
2. Touch the group between (No Group) and A ~ Z.
 - ① You can save up to 300 Memories in each group.

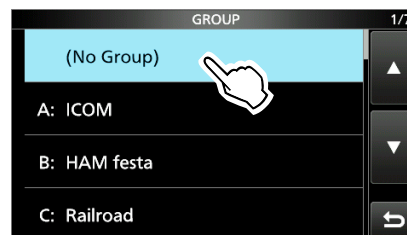

9. GPS OPERATION (ADVANCED)

GPS Memory

◇ Adding a GPS Memory

9. Writing the GPS Memory

1. Touch "<<Add Write>>."

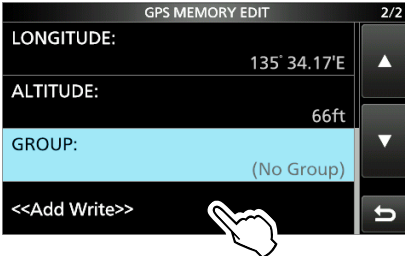

- ① If you edit a previously added GPS Memory, touch "<<Overwrite>>."
2. Touch [YES].
 - The data is added to the GPS memory, and then the selected GPS Memory group screen is displayed.
3. To close the GPS Memory group screen, push **EXIT** several times.

TIP:

To view the entered content:

Touch the GPS Memory channel. Rotate **MAIN DIAL** to check the whole content.

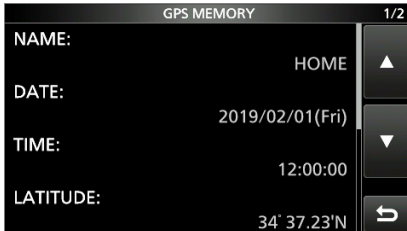

To cancel the entered data:

While entering or editing the GPS Memory, push **EXIT** to display the confirmation dialog. Touch [YES] to cancel entering and the display returns to the GPS Memory group screen.

◇ Entering the GPS Memory group name

You can enter a name for each GPS Memory group.

1. Open the GPS MEMORY screen.
MENU » **GPS > GPS Memory**
2. Touch the group that the name to be entered for 1 second.

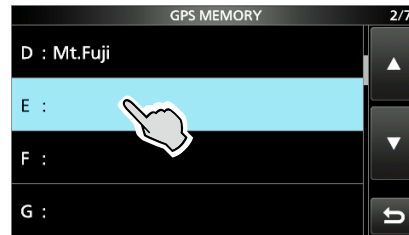

3. Touch "Edit Name."

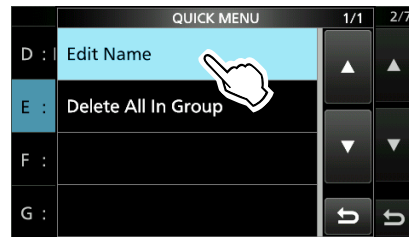

4. Enter a group name of up to 16 characters.
5. After entering, touch [ENT].

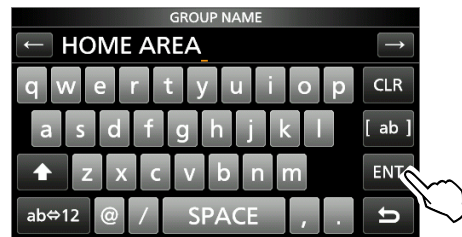

6. To close the GPS MEMORY screen, push **EXIT** several times.

9. GPS OPERATION (ADVANCED)

GPS Memory

◇ Deleting GPS Memory

You can delete the GPS Memories.

There are 2 ways to delete the Memories:

- Deletes all GPS Memory in a group.
- Deletes a specific GPS Memory.

NOTE: Deleted GPS Memories cannot be restored.

Example: Deleting all in the Group E.

1. Open the GPS MEMORY screen.
MENU » **GPS > GPS Memory**
2. Touch the group where the GPS Memory to delete is saved for 1 second.

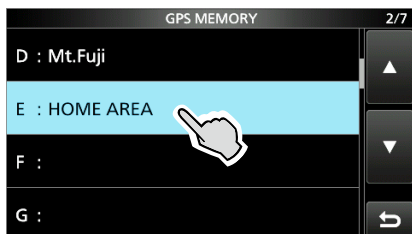

3. Touch "Delete All In Group."

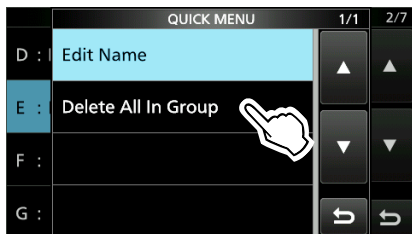

4. Touch [YES].
 - All GPS Memory in the selected group are deleted, then returns to the GPS MEMORY screen.
5. To close the GPS MEMORY screen, push **EXIT** several times.

TIP: Deleting a specific GPS Memory

You can delete a specific GPS Memory.

1. Touch the GPS Memory to delete.
2. Touch "Delete."

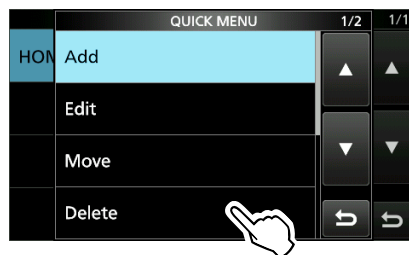

3. Touch [YES].
 - The selected GPS Memory is deleted.

9. GPS OPERATION (ADVANCED)

GPS Memory

◇Rearranging the display order of the GPS data

You can move the entered GPS Memories to rearrange their display order in the selected GPS Memory group.

① In order to move the GPS Memory out of their assigned Memory group, edit and move, and then save.

1. Open the GPS MEMORY screen.

MENU » **GPS > GPS Memory**

2. Touch the group where the GPS Memory you want to move is saved.

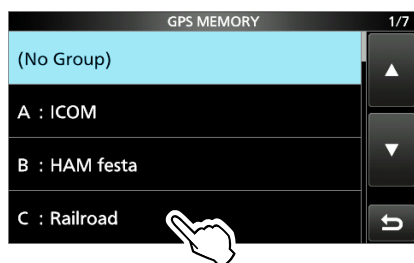

3. Touch the GPS Memory to move for 1 second.



4. Touch "Move."

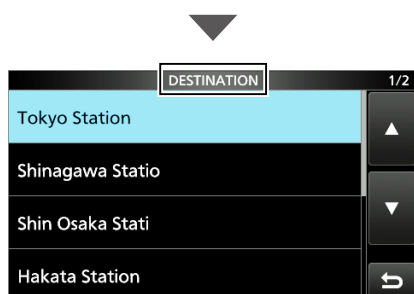
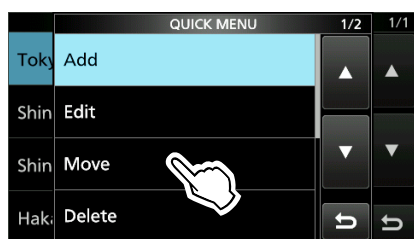

• "DESTINATION" blinks at the top the screen.

5. Touch the position to insert the Memory you want to move.

• The selected Memory is inserted above the destination Memory name.

① If you select "<<Move End>>," the Memory is moved to the bottom of the group.

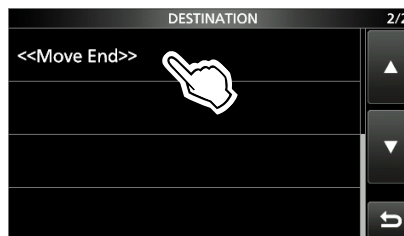

6. To close the GPS MEMORY screen, push **EXIT** several times.

9. GPS OPERATION (ADVANCED)

GPS Alarm

The transceiver can sound a GPS Alarm when a target station or position comes into the alarm area. This function can be set to a caller station, all GPS Memories, a selected GPS Memory group, or a selected GPS Memory.

Alarm Area (Group) (Setting plural stations)

When "All Memories" or a GPS Memory group is selected:

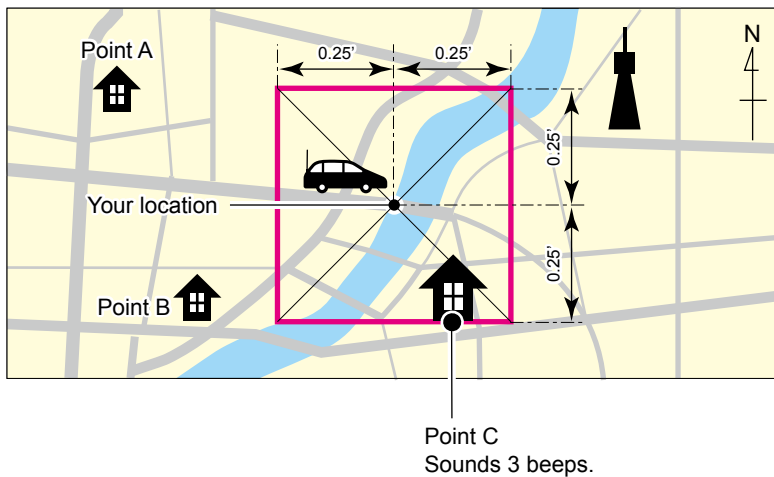

Alarm Area (RX/Memory) (Setting specific station)

When a specific GPS Memory is selected:

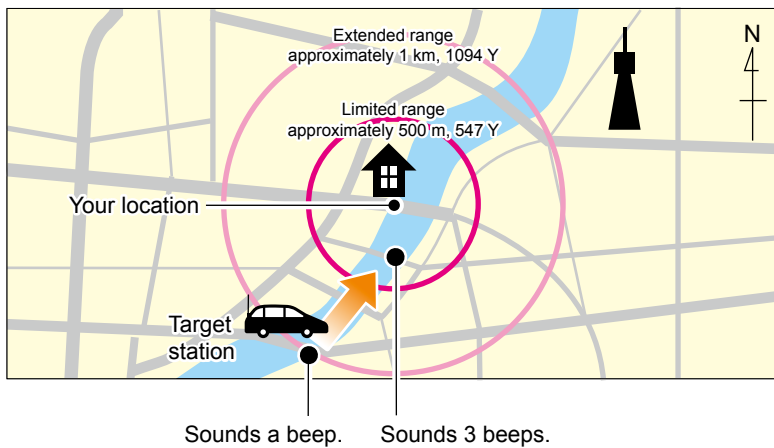

9. GPS OPERATION (ADVANCED)

GPS Alarm

◇ Setting the GPS Alarm function to All Memories (all GPS Memories)

1. Open the GPS ALARM screen.

MENU » **GPS > GPS Alarm**

2. Touch “Alarm Select.”

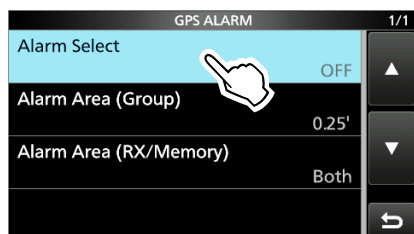

3. Touch “Group.”

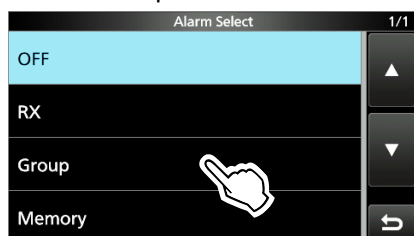

4. Touch “All Memories.”

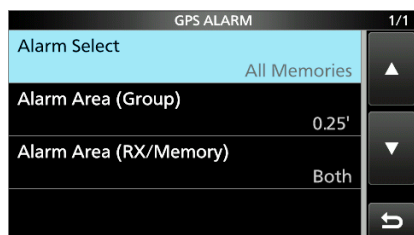
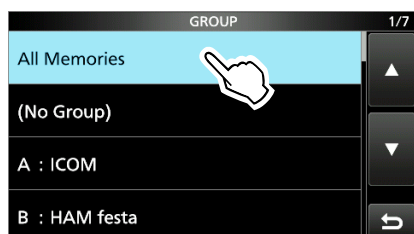

① If you want to set the alarm to a specific GPS Memory group, touch “(No Group)” or “A” to “Z.”

5. To close the GPS ALARM screen, push **EXIT** several times.

① Information

- When either one of the stations in the group enters the set range, the alarm sounds 3 times.
- When the transceiver sounds a GPS Alarm, “GPS ALARM” pops up on the screen, and “**7**” blinks. See the illustration below.
- To cancel the GPS Alarm function, touch “OFF” in step 3 to the left.



“GPS ALARM” pops up on the screen and the alarm sounds 3 times.

TIP: When selecting “All Memories,” “No Group,” or a GPS Memory group (A ~ Z) in step 4 to the left, you also have to set **Alarm Area (Group)** to use the GPS Alarm function.

MENU » **GPS > GPS Alarm > Alarm Area (Group)**

9. GPS OPERATION (ADVANCED)

GPS Alarm

◇ Setting the GPS Alarm function to RX (a caller station)

1. Open the GPS ALARM screen.

MENU » **GPS > GPS Alarm**

2. Touch “Alarm Select.”

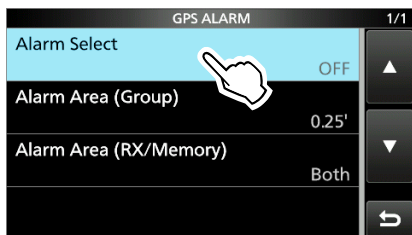

3. Touch “RX.”

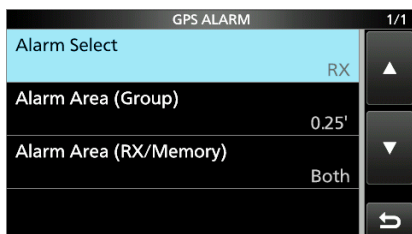
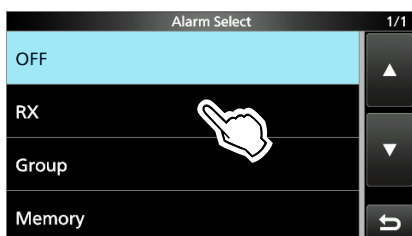

① If you want to set the alarm to a specific GPS Memory, touch “Memory” and then select a GPS Memory in a GPS Memory group.

4. To close the GPS ALARM screen, push **EXIT** several times.

① Information

- When a station with its GPS Alarm set enters within an approximate 1 kilometer (1094 yard) range, the alarm sounds once. When it enters within an approximate 500 meter (547 yard) range, the alarm sounds 3 times.
- When the transceiver sounds a GPS Alarm, “GPS ALARM” pops up on the screen, and “” blinks. See the illustration below.
- To cancel the GPS Alarm function, touch “OFF” in step 3 to the left.



“GPS ALARM” pops up on the screen and the alarm sounds, depending on the set range.

NOTE: Even if “RX” is selected in step 3, when the received signal has no position data, the GPS Alarm does not sound.

TIP: When selecting “RX” or a specific GPS Memory in step 3 to the left, you also have to set **Alarm Area (RX/Memory)** to use the GPS Alarm function.

MENU » **GPS > GPS Alarm > Alarm Area (RX/Memory)**

GPS SET

NOTE: The default settings shown below are for the USA transceiver version. The default settings may differ, depending on your transceiver version. To return to your transceiver version's default settings, push **QUICK** and touch "Default" returns to the default setting.

MENU » **GPS > GPS Set**

GPS Select (Default: External GPS)

Select how to capture position data.

① Data communication is disabled when you select "External GPS."

- OFF: A GPS receiver is not used.
- External GPS: Position data of an external GPS receiver is used for the GPS functions.
- Manual: Manually enter the current Latitude, Longitude, and Altitude in **Manual Position**.

GPS Receiver Baud Rate (Default: 9600)

Select the baud rate of the GPS receiver.

Manual Position (Default: LATITUDE: 0°00.00'N, LONGITUDE: 0°00.00'W, ALTITUDE: -----ft)

Manually enter the latitude, longitude, and Altitude of your current position.

① You can capture position data from the GPS receiver if "Capture From GPS" is selected.

MENU » **GPS**

GPS TX Mode (Default: OFF)

Select a GPS transmission mode to send a GPS position data while in the DV mode.

- OFF: Does not transmit a GPS data.
- D-PRS: Transmits a GPS data in the D-PRS format.
- NMEA: Transmits a GPS data in the NMEA format.

MENU » **GPS > GPS TX Mode > D-PRS**

Unproto Address (Default: API9700,DSTAR*)

Displays an unproto address of up to 56 alphanumeric characters.

NOTE: You should use the default address, and editing is not recommended.

TX Format (Default: Position)

Select the format to transmit the position data in the D-PRS mode.

- Position: The caller station is the mobile or base station.
- Object: Transmits a certain location's information, such as an event, earthquake, and so on. (time stamp data is included.)
- Item: Transmits repeater or antenna information that needs no time information. (time stamp data is not included.)
- Weather: Transmits weather information received from a weather device.

MENU » **GPS > GPS TX Mode > D-PRS > TX Format > Position**

Symbol (Default: House QTH (VHF))

Select the symbol that indicates your operating situation. The selected symbol channel's symbols (1~4) are transmitted along with the position data.

Editing a symbol

1. Touch the symbol channel for 1 second.
2. Touch "Edit Symbol."
3. Push **QUICK**.
4. Touch "Direct Input."
5. Touch [+]/[-] to edit the second digit.
6. Touch [+]/[-] to edit the first digit.

Selectable characters and symbols
<For the first digit> /, \, 0 to 9, A to Z
<For the second digit> A to Z, a to z, 0 to 9, ! " # \$ % & ' () * + , - . / : ; < = > ? @ [\] ^ _ ` { } ~

7. After selecting, touch [SET].
 - Sets the Symbol into the channel selected in step 1.

Selecting a preset symbol

1. Touch the symbol channel for 1 second.
2. Touch "Edit Symbol."
3. Touch the symbol.
 - Sets the Symbol into the channel selected in step 1.

9. GPS OPERATION (ADVANCED)

GPS SET

MENU » GPS > GPS TX Mode > D-PRS >
TX Format > **Position**

SSID (Default: ---)

Select an SSID based on APRS® to add to your call sign, to show your operating style to other stations. The addition methods of the SSID differ, depending on whether the call sign includes a space or not.

- ---: The space in call sign is converted to “-.”
 - ① If no text is entered after the space, the space will be deleted, and the space is not converted to “-.”
 - Example:** JA3YUA → JA3YUA
JA3YUA A → JA3YUA-A
- (-0): No SSID is added.
 - ① If a call sign includes a space, any text or digit after the space will be deleted.
 - Example:** JA3YUA → JA3YUA
JA3YUA A → JA3YUA
- -1~-15: Adds an SSID of -1 to -15 to your call sign.
 - ① **Example:** SSID is “-9.”
 - JA3YUA → JA3YUA-9
JA3YUA A → JA3YUA-9
- -A~-Z: Adds an SSID of -A to -Z to your call sign.
 - ① **Example:** SSID is “-Z.”
 - JA3YUA → JA3YUA-Z
JA3YUA A → JA3YUA-Z

TIP: About the SSID

To assist in identifying a station’s type, designated call sign SSIDs are used in D-PRS (or APRS®), according to a common guideline.

The guideline may be changed when the infrastructure environment, such as a product or network, is changed. Please check the latest guideline in the web site related to D-PRS and APRS®, and correctly set.

<http://aprs.org/aprs11/SSIDs.txt>

Comment

Enter a comment to transmit it with the D-PRS position data.

You can enter up to four comments.

The number of characters you can enter differs, depending on the Data Extension and Altitude settings.

Data Extension	Altitude	Characters entered (maximum)
OFF	OFF	43 (Default)
OFF	ON	35
Course/Speed	OFF	36
Course/Speed	ON	28
Power/Height/Gain/Directivity	OFF	36
Power/Height/Gain/Directivity	ON	28

The symbol “**J**” displays the transmittable comment range. Please note that the characters that exceed the range will not be transmitted.

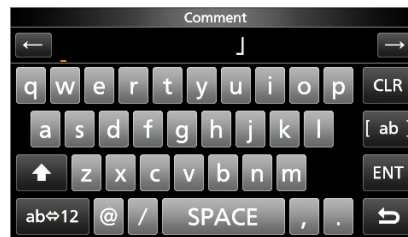

Transmittable comment range display
(In case of up to 28 characters)

9. GPS OPERATION (ADVANCED)

GPS SET

MENU » GPS > GPS TX Mode > D-PRS >
TX Format > **Position**

Time Stamp (Default: OFF)

Select the transmitting time stamp type.

The time stamp is transmitted with position data in the D-PRS mode, and UTC (Universal Time Coordinated) time is used.

① When your position is manually set, time stamp data is not transmitted.

- OFF: Does not transmit the time information.
- DHM: Transmits the time stamp in the Day, Hour, and Minute format.
- HMS: Transmits the time stamp in the Hour, Minute, and Second format.

Altitude (Default: OFF)

Select whether or not to transmit altitude data with the position data in the D-PRS mode.

① The number of characters you can enter in "Comment" differs, depending on the "Altitude" and "Data Extension" settings.

- OFF: No altitude data is transmitted.
- ON: Transmits altitude data with position data.

Data Extension (Default: OFF)

Select whether or not to transmit the Course/Speed data or Power/Height/Gain/Directivity data with position data in the D-PRS mode.

① The number of characters you can enter in "Comment" differs, depending on the "Altitude" and "Data Extension" settings.

- OFF: Does not transmit any information.
- Course/Speed: Transmits the course and speed data with the position data.
 - ① The course and speed data is not transmitted when your position is manually set.
 - ① When transmitting with this setting, your station is regarded as a mobile station.
- Power/Height/Gain/Directivity: Transmits the TX power level, height, antenna gain and antenna direction, along with the position data.
 - ① The Power, Height, Gain and Directivity data is transmitted even if your location is manually set.
 - ① When transmitting with this setting, your station is regarded as a base station.

Power (Default: 0W)

Select the TX power level of the base station, to transmit along with the position data.

① This item is displayed when "Data Extension" is set to "Power/Height/Gain/Directivity."

Options: Set to between 0, 1, 4, 9, 16, 25, 36, 49, 64, and 81 W.

Height (Default: 10ft)

Select the height of the base station's antenna, to transmit along with the position data.

① This item is displayed when "Data Extension" is set to "Power/Height/Gain/Directivity."

Options: Set to between 10, 20, 40, 80, 160, 320, 640, 1280, 2560, and 5120 feet.*

* If the Altitude/Distance unit is set to "m," select between 3, 6, 12, 24, 49, 98, 195, 390, 780, and 1561 meters.

Gain (Default: 0dB)

Select the gain of the base station's antenna, to transmit along with the position data.

① This item is displayed when "Data Extension" is set to "Power/Height/Gain/Directivity."

Options: Set to between 0 and 9 dB.

Directivity (Default: Omni)

Select the direction the base station's antenna was pointing, to transmit along with the position data.

① This item is displayed when "Data Extension" is set to "Power/Height/Gain/Directivity."

Options: Set to between Omni, 45° NE, 90° E, 135° SE, 180° S, 225° SW, 270° W, 315° NW and 360° N.

MENU » GPS > GPS TX Mode > D-PRS >
TX Format > **Object**

Object Name

Enter an Object name of up to 9 characters.

Data Type (Default: Live Object)

Set the Object's status.

- Live Object: The Object is valid.
- Killed Object: The Object is invalid.

Symbol (Default: Radio)

The symbol is an icon which represents Object's means of transportation or location. The saved symbol is transmitted along with the position data while in the D-PRS mode.

See page 9-28 for details of editing a symbol.

9. GPS OPERATION (ADVANCED)

GPS SET

MENU » GPS > GPS TX Mode > D-PRS >
TX Format > **Object**

Comment

Enter a comment.

The number of characters you can enter differs, depending on the Data Extension and Altitude data entry.

Data Extension	Altitude	Characters entered (maximum)
OFF	—	43 (Default)
OFF	Entered	35
Course/Speed	—	36
Course/Speed	Entered	28
Power/Height/Gain/Directivity	—	36
Power/Height/Gain/Directivity	Entered	28

The symbol "⏏" displays the transmittable comment range. Please note that the characters that exceed the range will not be transmitted.

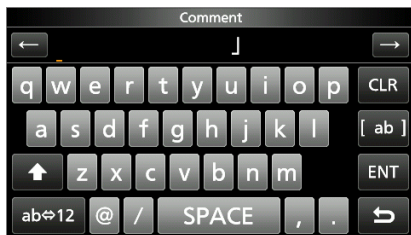

Transmittable comment range display
(In case of up to 28 characters)

Position

(Default: **LATITUDE: 0°00'00"N,**
LONGITUDE: 0°00'00"E, ALTITUDE: -----ft)

Displays the position information of the Object.
Push **QUICK** to open the window shown below.

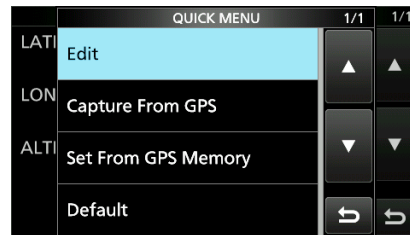

TIP: When you select "Capture From GPS" or "Set From GPS Memory," you can capture the position from the GPS, or set the Object's position from the GPS memory.

Entering the position information manually

1. Touch "Edit" on QUICK MENU.
 - The POSITION EDIT screen is displayed.
2. Touch "LATITUDE."
3. Enter a latitude.
 - ① Touch "N/S" to switch the north latitude and the south latitude.
4. Touch [ENT].
5. Touch "LONGITUDE."
6. Enter a longitude.
 - ① Touch "E/W" to switch the east longitude and the west longitude.
7. Touch [ENT].
8. Touch "ALTITUDE."
9. Enter an altitude.
 - ① After entering, touch [+/-] to switch "+" and "-."
10. Touch [ENT].
11. Touch "<<Write>>."
12. Touch "YES."
 - The position information is entered.

9. GPS OPERATION (ADVANCED)

GPS SET

MENU » GPS > GPS TX Mode > D-PRS >
TX Format > **Object**

Data Extension (Default: OFF)

Select whether or not to transmit the Course/Speed data or Power/Height/Gain/Directivity data along with the position data in the D-PRS mode.

① The number of characters you can enter in "Comment" differs, depending on the "Altitude" and "Data Extension" settings.

- OFF: Does not transmit any information.
- Course/Speed: Transmits the course and speed data with the position data.
 - ① The course and speed data is not transmitted when your position is manually set.
- Power/Height/Gain/Directivity: Transmits the TX power level, Height, Gain and Directivity data, along with the position data.
 - ① The Power, Height, Gain and Directivity data is transmitted even if your location is manually set.

Course (Default: 0°)

Set the Object's course to between 0° and 360°.

① This item is displayed when "Data Extension" is set to "Course/Speed."

Speed (Default: 0mph)

Set the Object's speed to between 0 and 1150 mph.*

* If the Speed unit is set to "km/h," select between 0 to 1850 km/h, or set to "knots," select between 0 and 999 knot.

① This item is displayed when "Data Extension" is set to "Course/Speed."

Power (Default: 0W)

Select the TX power level of Object, to transmit along with the position data.

① This item is displayed when "Data Extension" is set to "Power/Height/Gain/Directivity."

Options: Set to between 0, 1, 4, 9, 16, 25, 36, 49, 64, and 81 W.

Height (Default: 10ft)

Select the height of the Object's antenna, to transmit along with the position data.

① This item is displayed when "Data Extension" is set to "Power/Height/Gain/Directivity."

Options: Set to between 10, 20, 40, 80, 160, 320, 640, 1280, 2560, and 5120 feet.*

* If the Altitude/Distance unit is set to "m," select between 3, 6, 12, 24, 49, 98, 195, 390, 780, and 1561 meters.

Gain (Default: 0dB)

Select the gain of the Object's antenna, to transmit along with the position data.

① This item is displayed when "Data Extension" is set to "Power/Height/Gain/Directivity."

Options: Set to between 0 and 9 dB.

Directivity (Default: Omni)

Select the direction the Object's antenna was pointing, to transmit along with the position data.

① This item is displayed when "Data Extension" is set to "Power/Height/Gain/Directivity."

Options: Set to between Omni, 45° NE, 90° E, 135° SE, 180° S, 225° SW, 270° W, 315° NW and 360° N.

SSID (Default: ---)

Select an SSID based on APRS® to add to your call sign, to show your operating style to other stations. The addition methods of the SSID differ, depending on whether the call sign includes a space or not.

① See page 9-29 for details of the SSID.

- ---: The space in call sign is converted to "-."
- (-0): No SSID is added.
- -1~-15: Adds an SSID of -1 to -15 to your call sign.
- -A~Z: Adds an SSID of -A to -Z to your call sign.

Time Stamp (Default: OFF)

Select the transmitting time stamp type.

The time stamp is transmitted with position data in the D-PRS mode, and UTC (Universal Time Coordinated) time is used.

- DHM: Transmits the time stamp in the Day, Hour, and Minute format.
- HMS: Transmits the time stamp in the Hour, Minute, and Second format.

MENU » GPS > GPS TX Mode > D-PRS >
TX Format > **Item**

Item Name

Enter an Item name of up to 9 characters.

Data Type (Default: Live Item)

Set the Item's status.

- Live Item: The Item is valid.
- Killed Item: The Item is invalid.

Symbol (Default: Radio)

The symbol is an icon which represents Item's means of transportation or location. The saved symbol is transmitted along with the position data while in the D-PRS mode.

See page 9-28 for details of editing a symbol.

9. GPS OPERATION (ADVANCED)

GPS SET

MENU » GPS > GPS TX Mode > D-PRS > TX Format > **Item**

Comment

Enter a comment.

The number of characters you can enter differs, depending on the Data Extension and Altitude data entry.

Data Extension	Altitude	Characters entered (maximum)
OFF	—	43 (Default)
OFF	Entered	35
Course/Speed	—	36
Course/Speed	Entered	28
Power/Height/Gain/Directivity	—	36
Power/Height/Gain/Directivity	Entered	28

The symbol "␣" displays the transmittable comment range. Please note that the characters that exceed the range will not be transmitted.

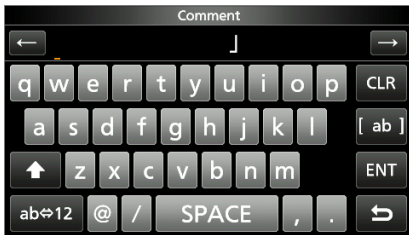

Transmittable comment range display
(In case of up to 28 characters)

Position

(Default: LATITUDE: 0°00'00"N, LONGITUDE: 0°00'00"E, ALTITUDE: -----ft)

Displays the position information of the Item.
Push **QUICK** to open the window shown below.

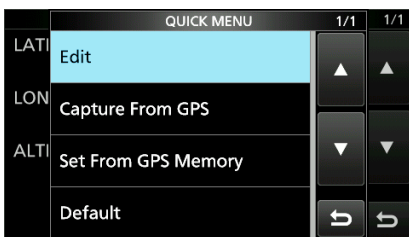

TIP: When you select "Capture From GPS" or "Set From GPS Memory," you can capture the position from the GPS, or set the Item's position from the GPS memory.

① See "Entering the position information manually" (p. 9-31) for details.

Data Extension **(Default: OFF)**

Select whether or not to transmit the Course/Speed data or Power/Height/Gain/Directivity data along with the position data in the D-PRS mode.

① The number of characters you can enter in "Comment" differs, depending on the "Altitude" and "Data Extension" settings.

- OFF: Does not transmit any information.
- Course/Speed: Transmits the course and speed data with the position data.
 - ① The course and speed data is not transmitted when your position is manually set.
- Power/Height/Gain/Directivity: Transmits the TX power level, Height, Gain and Directivity data, along with the position data.
 - ① The Power, Height, Gain and Directivity data is transmitted even if your location is manually set.

Course **(Default: 0°)**

Set the Item's course to between 0° and 360°.

① This item is displayed when "Data Extension" is set to "Course/Speed."

Speed **(Default: 0mph)**

Set the Item's speed to between 0 and 1150 mph.*

* If the Speed unit is set to "km/h," select between 0 to 1850 km/h, or set to "knots," select between 0 and 999 knot.

① This item is displayed when "Data Extension" is set to "Course/Speed."

Power **(Default: 0W)**

Select the TX power level of Item, to transmit along with the position data.

① This item is displayed when "Data Extension" is set to "Power/Height/Gain/Directivity."

Options: Set to between 0, 1, 4, 9, 16, 25, 36, 49, 64, and 81 W.

Height **(Default: 10ft)**

Select the height of the Item's antenna, to transmit along with the position data.

① This item is displayed when "Data Extension" is set to "Power/Height/Gain/Directivity."

Options: Set to between 10, 20, 40, 80, 160, 320, 640, 1280, 2560, and 5120 feet.*

* If the Altitude/Distance unit is set to "m," select between 3, 6, 12, 24, 49, 98, 195, 390, 780, and 1561 meters.

9. GPS OPERATION (ADVANCED)

GPS SET

MENU » GPS > GPS TX Mode > D-PRS >
TX Format > **Item**

Gain (Default: 0dB)

Select the gain of the Item's antenna, to transmit along with the position data.

① This item is displayed when "Data Extension" is set to "Power/Height/Gain/Directivity."

Options: Set to between 0 and 9 dB.

Directivity (Default: Omni)

Select the direction the Item's antenna was pointing, to transmit along with the position data.

① This item is displayed when "Data Extension" is set to "Power/Height/Gain/Directivity."

Options: Set to between Omni, 45° NE, 90° E, 135° SE, 180° S, 225° SW, 270° W, 315° NW and 360° N.

SSID (Default: ---)

Select an SSID based on APRS® to add to your call sign, to show your operating style to other stations. The addition methods of the SSID differ, depending on whether the call sign includes a space or not.

① See page 9-29 for details of the SSID.

- ---: The space in call sign is converted to "-."
- (-0): No SSID is added.
- -1~-15: Adds an SSID of -1 to -15 to your call sign.
- -A~-Z: Adds an SSID of -A to -Z to your call sign.

MENU » GPS > GPS TX Mode > D-PRS >
TX Format > **Weather**

Symbol (Default: WX Station)

The symbol is an icon which represents weather station's means of transportation or location. The saved symbol is transmitted along with the position data while in the D-PRS mode.

① See page 9-28 for details of editing a symbol.

SSID (Default: ---)

Select an SSID based on APRS® to add to your call sign, to show your operating style to other stations. The addition methods of the SSID differ, depending on whether the call sign includes a space or not.

① See page 9-29 for details of the SSID.

- ---: The space in call sign is converted to "-."
- (-0): No SSID is added.
- -1~-15: Adds an SSID of -1 to -15 to your call sign.
- -A~-Z: Adds an SSID of -A to -Z to your call sign.

Comment

Enter a comment of up to 43 characters.

Time Stamp (Default: OFF)

Select the transmitting time stamp type.

The time stamp is transmitted with position data in the D-PRS mode, and UTC (Universal Time Coordinated) time is used.

- OFF: Does not transmit the time information.
- DHM: Transmits the time stamp in the Day, Hour, and Minute format.
- HMS: Transmits the time stamp in the Hour, Minute, and Second format.

9. GPS OPERATION (ADVANCED)

GPS SET

MENU » **GPS > GPS TX Mode > NMEA**

GPS Sentence (Default: GGA)

Select sentences to be transmitted in the GPS mode to transmit position data. Set to between RMC, GGA, GLL, VTG, GSA, and GSV.

NOTE: Set the GSV sentence to OFF when sending the GPS message to conventional digital transceivers. The GSV sentence is incompatible with them.

① Information

- Up to 4 GPS sentences can be set at a time.
- Displays "✓" when the sentence is set to ON.
- Even if **GPS Auto TX** is set to "5 sec," when 4 sentences are selected, the time is automatically changed to "10 sec." (p. 9-40)
- "VTG," "GSA," and "GSV" sentences is not transmitted when your position has been manually set.

GPS Message

Enter a GPS message of up to 20 alphanumeric characters. (p. 9-19)

NOTE: When you do not want to send a message, delete the entered message.

MENU » **GPS**

GPS Information

Displays the GPS satellite direction, elevation angle, satellite number, and receiving status. (p. 9-9)

TIP: Contents of GPS sentence

The Time Stamp is displayed based on the UTC (Universal Time Coordinated) time.

Sentence	Lon/Lat	Alt	GPS Time Stamp (UTC)	Date (UTC)	Status	2D/3D	COG (True)	SOG (knot)
RMC	✓		✓	✓	✓		✓	✓
GGA	✓	✓	✓		✓			
GLL	✓		✓		✓			
VTG							✓	✓
GSA					✓	✓		
GSV								

Sentence	Others
RMC	Magnetic variation, Mode Indicator
GGA	Number of satellites in use, HDOP, Geoidal separation, Age of Differential GPS data Differential reference station ID
GLL	Mode Indicator
VTG	COG (Magnetic north), SOG (km/h), Mode Indicator
GSA	PRN number of satellites used in solution, PDOP, HDOP, VDOP
GSV	Total number of sentences, Sentence number, Total number of satellites in view, Satellite information (ID, Elevation, Azimuth, S/N)

9. GPS OPERATION (ADVANCED)

GPS SET

MENU » **GPS**

GPS Position

Your current position, received position, or GPS Memory Alarm position information is displayed. (p. 9-4)

Rotating **MAIN DIAL** selects the MY, RX, MEM, and ALM screens.

MY screen (MY Position)

Compass*1	Displays your direction.
Latitude	Displays your latitude.
Longitude	Displays your longitude.
GL	Displays the grid locator based on the latitude and longitude of your position.
ALT	Displays your own altitude.
SPEED	Displays your speed over ground.
TIME	Displays current time received from the GPS.
COURSE	Displays your direction heading.

① When **GPS Select** is set to “Manual,” the screen displays only latitude, longitude, altitude, GL (Grid locator), and time (internal clock).

RX screen (Received position of the other station)
Depending on the caller’s TX mode or TX format, the displayed items and these meanings are different. The following lists describe the items for each category.

No data is displayed when no position data is received on your transceiver.

<1. When the caller’s TX mode is NMEA>

Compass*1	Displays the caller’s direction from your position.
Latitude	Displays the caller’s latitude.
Longitude	Displays the caller’s longitude.
GL	Displays the grid locator based on the latitude and longitude of the caller’s position.
ALT	Displays the caller’s altitude.
DST	Displays the caller’s distance from your position.
COURSE	Displays the caller’s direction over ground.
SPEED	Displays the caller’s speed.
GPS Time Stamp	Displays the time that the caller acquired the position data.
Call sign	Displays the caller’s call sign.

<2. When the caller’s TX format is D-PRS Position (Mobile station)>

Compass*1	Displays the caller’s direction from your position.
Latitude	Displays the caller’s latitude.
Longitude	Displays the caller’s longitude.
GL	Displays the grid locator based on the latitude and longitude of the caller’s position.
ALT	Displays the caller’s altitude.
DST	Displays the caller’s distance from your position.
COURSE	Displays the caller’s direction over ground.
SPEED	Displays the caller’s speed.
Symbol	Displays the caller’s D-PRS symbol.
SSID	Displays the caller’s SSID.
GPS Time Stamp	Displays the time that the caller acquired the position data.
Call sign	Displays the caller’s call sign (with SSID).

*1 You can change the direction in the Quick Menu window.

9. GPS OPERATION (ADVANCED)

GPS SET

MENU » **GPS**

GPS Position (continued)

<3. When the caller's TX format is D-PRS Position (Base station)>

Compass*1	Displays the caller's direction from your position.
Latitude	Displays the caller's latitude.
Longitude	Displays the caller's longitude.
GL	Displays the grid locator based on the latitude and longitude of the caller's position.
ALT	Displays the caller's altitude.
DST	Displays the caller's distance from your position.
POWER	Displays the caller's TX power level.
HEIGHT	Displays the caller's antenna height.
GAIN	Displays the caller's antenna gain.
DIRECT	Displays the direction of caller's antenna was pointing.
Symbol	Displays the caller's D-PRS symbol.
SSID	Displays the caller's SSID.
GPS Time Stamp	Displays the time that the caller acquired the position data.
Call sign	Displays the caller's call sign (with SSID).

<4. When the caller's TX format is D-PRS Object/Item>

Compass*1	Displays the Object/Item's direction from your position.
Object/Item name	Displays the Object/Item's name.
Latitude	Displays the Object/Item's latitude.
Longitude	Displays the Object/Item's longitude.
GL	Displays the grid locator based on the latitude and longitude of the Object/Item's position.
ALT	Displays the Object/Item's altitude.
DST	Displays the Object/Item's distance from your position.
COURSE	Displays the Object/Item's direction over ground.
SPEED	Displays the Object/Item's speed.
POWER	Displays the Object/Item's TX power level.
HEIGHT	Displays the Object/Item's antenna height.
GAIN	Displays the Object/Item's antenna gain.
DIRECT	Displays the direction that the Object/Item's antenna was pointing.
Symbol	Displays the Object/Item's D-PRS symbol.
SSID	Displays the caller's SSID.
GPS Time Stamp	Displays the time that the caller sent the Object's data.
Call sign	Displays the caller's call sign (with SSID).

① When the object or Item is disabled, "KILLED" is displayed.

*1 You can change the direction in the Quick Menu window.

9. GPS OPERATION (ADVANCED)

GPS SET

MENU » **GPS**

GPS Position (continued)

<5. When the caller's TX format is D-PRS Weather>

Compass*1	Displays the caller's direction from your position.
Latitude	Displays the caller's latitude.
Longitude	Displays the caller's longitude.
GL	Displays the grid locator based on the latitude and longitude of the caller's position.
DST	Displays the caller's distance from your position.
TEMP	Displays the temperature of the caller station's area.
RAIN	Displays the rainfall of the caller station's area.
WIND DIR	Displays the wind direction of the caller station's area.
WIND SPD	Displays the wind speed of the caller station's area.
BARO	Displays the barometric pressure of the caller station's area.
HUMI	Displays the humidity of the caller station's area.
Symbol	Displays the caller station's D-PRS symbol.
SSID	Displays the caller's SSID.
GPS Time Stamp	Displays the time that the caller acquired the position data.
Call sign	Displays the caller's call sign (with SSID).

MEM screen (GPS memory alarm position)

Compass*1	Displays GPS Memory channel's direction from your position.
Latitude	Displays GPS Memory channel's latitude.
Longitude	Displays GPS Memory channel's longitude.
GL	Displays the grid locator based on the latitude and longitude of GPS Memory channel's.
DST	Displays GPS Memory channel's distance from your position.
GPS memory name*2	Displays the selected GPS memory name.

ALM screen (GPS alarm position)

Compass*1	Displays GPS Alarm area's direction from your position.
Latitude	Displays GPS Alarm area's latitude.
Longitude	Displays GPS Alarm area's longitude.
GL	Displays the grid locator based on the latitude and longitude of GPS Alarm area's.
DST	Displays GPS Alarm area's distance from your position.
GPS Alarm*2	Displays "RX," GPS memory group name, or GPS memory name specified for the GPS Alarm function.

*1 You can change the direction in the Quick Menu window.

*2 You can change these items in the Quick Menu window.

9. GPS OPERATION (ADVANCED)

GPS SET

MENU » **GPS**

GPS Memory

The transceiver has 300 GPS Memory channels to save the received position data, or often-used position data, with an alphanumeric channel name. The channels can be divided into the "(No Group)" group and each Memory group (A to Z) for easy Memory management.

The display of the GPS Memory

(No Group)	GPS Memories not assigned to any group
A ~ Z : Group Name	GPS Memories assigned to the selected group.

GPS Memory Groups (A ~ Z)

GROUP NAME	GPS Memory Group name (Up to 16 alphanumeric characters)
------------	---

① You can edit the GPS Memory Group name. (p. 9-22)

GPS Memory channels

NAME	GPS memory channel name (Up to 16 alphanumeric characters)
DATE	Saved date
TIME	Saved time
LATITUDE	Saved position (latitude)
LONGITUDE	Saved position (longitude)
ALTITUDE	Saved altitude
GROUP	The group letter and the name of the group

① When you save the received position data on the GPS POSITION screen, the received station's call sign is used as the GPS Memory name.

① In the Quick Menu window, you can edit the GPS Memory contents, such as the GPS Memory name.

MENU » **GPS > GPS Alarm**

Alarm Select

(Default: OFF)

Select the target positions for the GPS Alarm function.

- OFF: Turns OFF the function.
- RX: The GPS Alarm sounds when a target (the last received position) enters in your active alarm range.
- Group: The GPS Alarm sounds when a target (positions in the GPS Memory, or in the selected GPS Memory Group) enters in your active alarm range.
- Memory: The GPS Alarm sounds when a target (the entered position in the GPS Memory) enters in the active alarm range.

Alarm Area (Group)

(Default: 0.25')

Set the GPS active alarm range.

When a target enters in this set active alarm range, the GPS Alarm sounds and the GPS Alarm icon blinks.

① When **Alarm Select** is set to "Group," this setting is enabled.

Ranges differs, depending on **Latitude/Longitude** setting.

- Latitude/Longitude = ddd°mm.mm'
Ranges: 00.08' to 59.99' (0.01' steps)
- Latitude/Longitude = ddd°mm'ss"
Ranges: 00'05" to 59'59" (0'01" steps)
- Latitude/Longitude = ddd.dddd°
Ranges: 0.0014° to 0.9999° (0.0001° steps)

Example:

When a target enters in the active alarm range, the GPS Alarm sounds and the GPS alarm icon blinks.

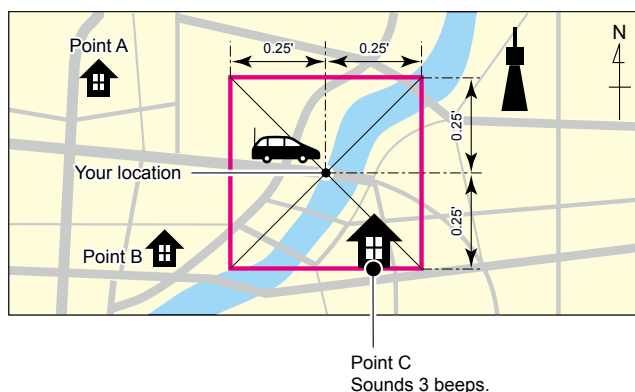

9. GPS OPERATION (ADVANCED)

GPS SET

MENU » **GPS > GPS Alarm**

Alarm Area (RX/Memory) (Default: Both)

Select the GPS active alarm range.

When a target enters in the active alarm range, the GPS Alarm sounds and the GPS alarm icon blinks.

① When **Alarm Select** is set to “RX” or “Memory,” this setting is enabled. (p. 9-39)

- **Limited:** The transceiver sounds 3 beeps and the GPS Alarm icon blinks when the target enters the 500 meter range.
- **Extended:** The transceiver sounds 3 beeps and the GPS Alarm icon blinks when the target enters the 1 kilometer range.
- **Both:** The transceiver sounds a beep and the GPS Alarm icon blinks when the target enters the 1 kilometer range, and sounds 3 beeps and the icon blinks when it enters the 500 meter range. When the target exits the 500 meter range, but is still in the 1 kilometer range, the icon continues to blink, but no beeps sound.

Example:

When a target station enters in the active alarm range (500 meter or 1 kilometer range, depending on the setting), the GPS Alarm sounds and the GPS Alarm icon blinks.

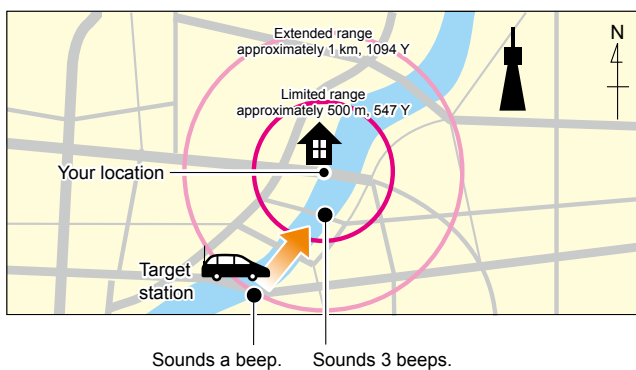

MENU » **GPS**

GPS Auto TX (Default: OFF)

Select an option for the GPS automatic transmission function.

This function automatically transmits the current position data received from a GPS receiver, as well as any entered GPS message, at the set interval.

NOTE: When **GPS TX Mode** is “NMEA,” set **GPS Select** to “External GPS.” If you set to “Manual” or “OFF,” the current position data is automatically transmitted.

- **OFF:** Does not automatically transmit the position data. (When you push **TRANSMIT** or microphone’s [PTT], the transceiver transmits the position data.)
- **5 sec to 30 min:** Transmits the current position data at the selected interval (5*, 10, or 30 seconds, or 1, 3, 5, 10, or 30 minutes).
* Not displayed when you set 4 GPS sentences in **GPS Sentence**. (p. 9-18)

Section 10 D-STAR OPERATION (BASIC)

Unique features of D-STAR	10-2
What is D-STAR?	10-2
About the DR function	10-3
Ways to Communicate with the DR function	10-3
DV and DD modes.....	10-3
Enter your call sign (MY) into the transceiver.....	10-4
Register your call sign at a gateway repeater	10-5
Making a Simplex call.....	10-6
Accessing repeaters	10-7
Receiving.....	10-8
Capturing a call sign.....	10-9
Making a Local CQ call.....	10-9
Making a Gateway CQ call.....	10-10
Calling an individual station.....	10-10
Saving settings	10-11
Updating the repeater list	10-12
“FROM” (Access repeater) setting.....	10-14
“TO” (Destination) setting	10-15

10. D-STAR OPERATION (BASIC)

Unique features of D-STAR

- Easy Cross band operation through the repeater

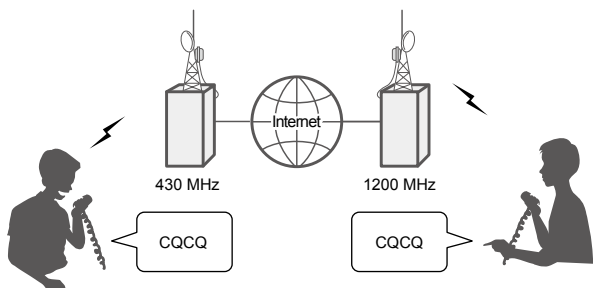

- The Call Sign Capture key **TONE(RX-CS)** makes call sign capture easy!

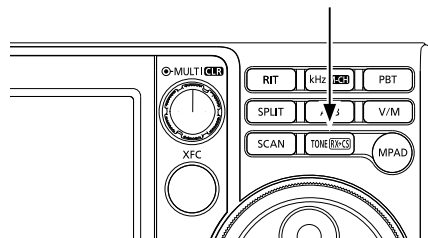

- Easy call sign entry with the Repeater list or TX/RX History

What is D-STAR?

- D-STAR is a digital protocol standard developed by the Japan Amateur Radio League (JARL). The system includes the DV mode for Digital Voice and the DD mode for Digital Data communications.
- D-STAR supports a comprehensive repeater system linked through the Internet, enabling you to make QSOs with stations near or far from your location.
- D-STAR supports the DV mode at 4.8 kbps. Your call sign data, and either a short message, or GPS data can be transmitted simultaneously with your voice signal.

Advanced Amateur radio technology of D-STAR

The DV mode has a bandwidth of only 6 kHz, compared to 16 kHz for the analog FM mode, with 5 kHz deviation. D-STAR utilizes the well-know GMSK modulation method that makes very efficient use of occupied bandwidth.

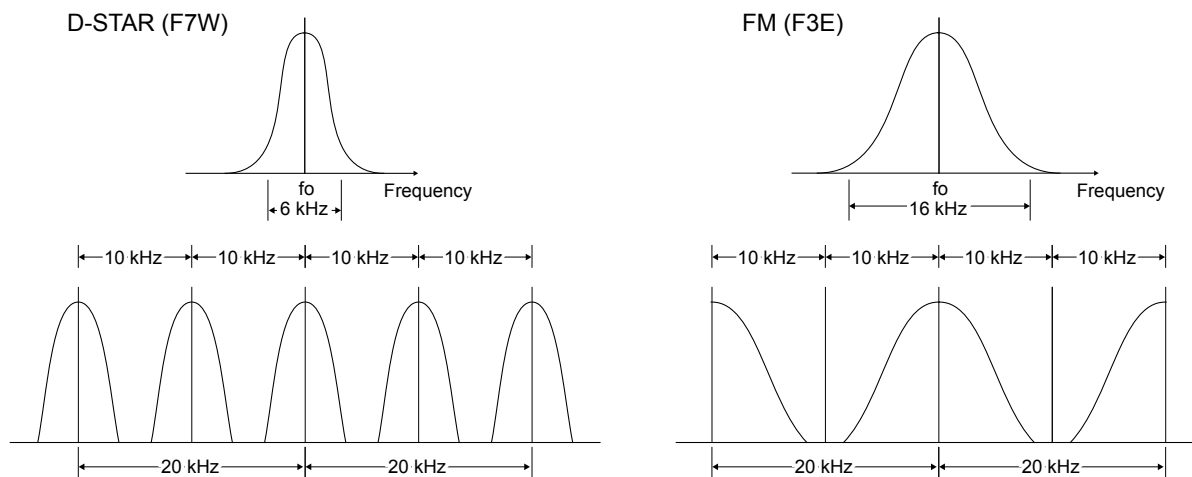

D-STAR occupies 10 kHz. The sound quality is good even though the bandwidth is narrow.

The regular FM mode occupies 20 kHz that is a double the bandwidth of D-STAR.

10. D-STAR OPERATION (BASIC)

Before starting D-STAR, the following steps are needed.

- IMPORTANT!**
- STEP 1** Enter your call sign (MY) into the transceiver. (p. 10-4)
 - STEP 2** Register your call sign (MY) to a gateway repeater. (p. 10-5)
 - STEP 3** Enter your D-STAR equipment into your registration form. (p. 10-5)

► You have completed the steps!!

About the DR function

You can easily use D-STAR repeaters with the D-STAR Repeater (DR) function. With this function, you can select the preset repeater or frequency in "FROM" (access repeater), and Your call sign in "TO" (destination) on the DR screen, as shown below.

To display the DR screen, hold down **CALLDR** for 1 second.

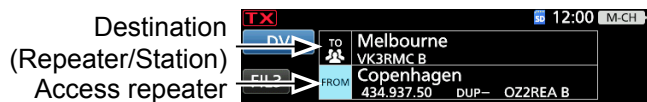

NOTE: If the repeater set in "FROM" (Access Repeater) has no Gateway, you cannot make a Gateway call.

DV and DD modes

DV (Digital Voice) mode

- Clear voice communication
- Simultaneous communication of the voice and simple data

DD (Digital Data) mode

- 128 kbps data communication
- Internet connection

① See section 13 for details of the DD mode.

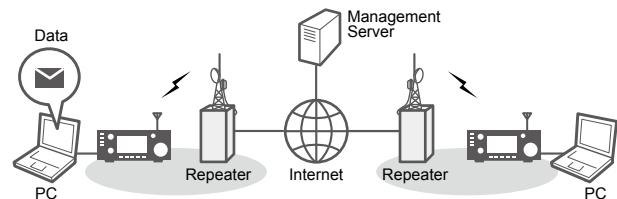

Ways to Communicate with the DR function

With the DR function, the transceiver has 3 ways to communicate.

Local Area call: To call through your local area (access) repeater.

Gateway call: To call through your local area (access) repeater, repeater gateway, and the Internet to your destination repeater or individual station's last used repeater, using Call Sign Routing.

Simplex call*: To call another station not using a repeater.

* You can make a simplex call. (p. 10-6)

NOTE:

- Using the repeater list is required to use the DR function. (p. 10-12)
- Before operating in the Duplex mode, BE SURE to check whether the repeater is busy, or not. If the repeater is busy, wait until it is clear, or ask for a 'break' using a method acceptable to your local procedures.
- The transceiver has the Time-Out Timer function for the DV Repeater operation. The timer limits a continuous transmission. Warning beeps will sound approximately 30 seconds before time-out and then again immediately before the time-out.

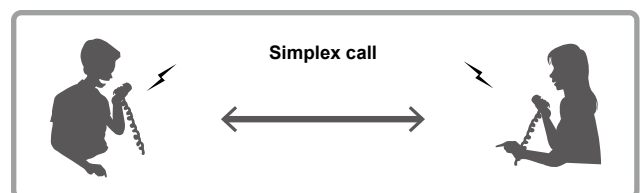
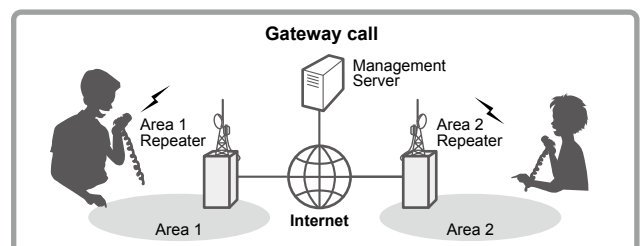
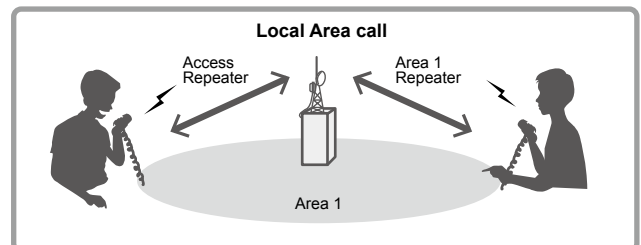

10. D-STAR OPERATION (BASIC)

Enter your call sign (MY) into the transceiver

To operate D-STAR, you must first enter your call sign into the MY call sign memory. You can enter up to 6 MY call signs.

NOTE:

- Your MY call sign must match the call sign registered on a gateway repeater. (p. 10-5)
- The MY Call sign in the instructions is ONLY an example that is used in explanations. You MUST enter your own call sign, the one that was assigned to you and is on your license.

Example: Enter "JA3YUA" as your own call sign into "1."

1. Open the MY CALL SIGN screen.

MENU » **SET > My Station > My Call Sign (DV)**

2. Touch the number for 1 second.

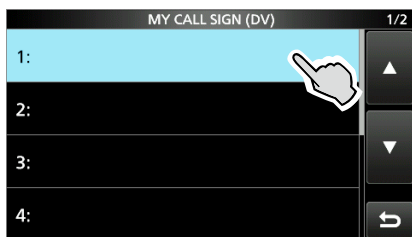

3. Touch "Edit."

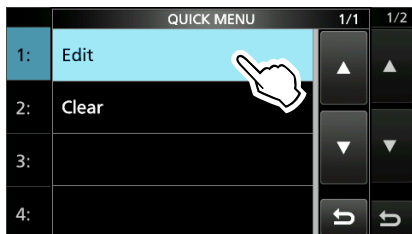

4. Enter your own call sign, then touch [ENT].

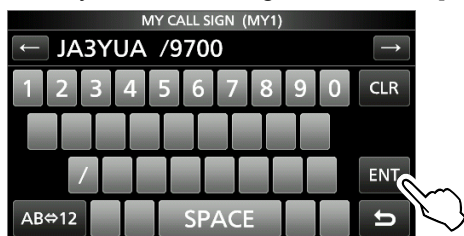

5. Touch the entered call sign.

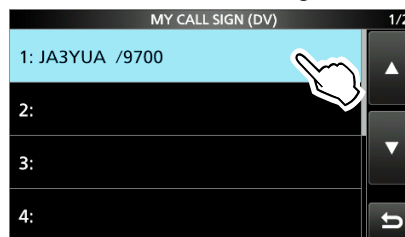

- Sets the call sign to be used as MY call sign.

6. To close the MY STATION screen, push **EXIT** several times.

TIP: You can enter a note of up to 4 characters, such as the model of the transceiver, name, area name, after your call sign.

10. D-STAR OPERATION (BASIC)

Register your call sign at a gateway repeater

To make a Gateway call through the Internet, you must register your call sign at a repeater that has a gateway, usually one near you.

About the registration process described:

This section describes the call sign registration process at a repeater that is connected to the US Trust server.

There are other systems as well, and they have their own registration process. For information on how to register on one of them, contact the administrator of a repeater that uses the alternate system.

NOTE: If needed, ask the gateway repeater administrator for call sign registration instructions.

Step 1: Access the call sign registration screen

1. Access the following URL to find the gateway repeater closest to you.
<http://www.dstarusers.org/repeaters.php>
2. Click the call sign of the repeater that you want to register to.
3. Click the "Gateway Registration URL:" link address.
4. The "D-STAR Gateway System" screen is displayed.
Click <Register> to start the New User registration.

The screenshot shows the "D-STAR Gateway System" interface. At the top left is the D-STAR logo, and at the top right is the text "D-STAR Gateway System (REV 1.0)". Below this, there are two main sections: "Already registered?" and "New user?". The "Already registered?" section includes the text "Login with CallSign and Password" and "Please note that CallSign and Password are case sensitive! CallSign must be in Upper Case!". It features input fields for "CallSign:" and "Password:", a "Login" button, and a "Click" label. The "New user?" section includes the text "Register here for D-STAR access. Registering takes just a few seconds, and you won't have to enter your personal information again the next time you visit here." It features a "Register" button and a "Click" label. At the bottom, there is a small disclaimer: "D-STAR is a digital protocol developed by the Japan Amateur Radio League (the JARL) and stands for Digital Smart Technology for Amateur Radio."

Step 2: Register your call sign

1. Follow the registration instructions found there.
2. When you receive a notification from the administrator, your call sign registration has been approved.

NOTE: It may take a few days for the administrator to approve you.

Step 3: Register your personal information

After your registration is approved, log in your personal account with your registered call sign and password.

This is a duplicate of the screenshot in Step 1, showing the "D-STAR Gateway System" interface with login and registration options.

Step 4: Register your D-Star equipment

1. Register your D-STAR equipment information. Ask the gateway repeater administrator for details.
2. When your registration is complete, log out of your personal account, and start using the D-STAR network.

NOTE: You must register your D-STAR equipment **BEFORE** you make Gateway Repeater calls.

10. D-STAR OPERATION (BASIC)

Making a Simplex call

This section describes the simplex operation (through no repeater).

NOTE: Depending on the transceiver's version, the frequencies may be different. Check for usable frequencies for your operating area.

What is a Simplex Call?

A simplex call is a direct call to another station on a single frequency, not using a repeater.

Example: Making a simplex call on 445.670 MHz.

Step 1: Set "FROM" (Simplex channel)

1. Select the operating band.
2. Hold down **CALLDR** for 1 second to display the DR screen.
3. Touch "FROM" to select, and then touch "FROM" again.



4. Touch "Repeater List."
5. Touch "Simplex."
6. Touch the desired frequency.
(Example: 445.670 MHz)

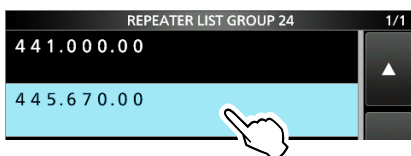

- Return to the DR screen, and the selected frequency is displayed in "FROM."
 - "CQCQCQ" is displayed in "TO."
- ① If a station call sign is set in "TO," select "Local CQ" in the "TO SELECT" screen to set "CQCQCQ" in "TO."

Step 2: Hold down [PTT] to transmit

Push **TRANSMIT**, or hold down the microphone's [PTT] to transmit.

TIP: You can change the simplex frequencies on the MENU screen.

MENU » DV/DD MEMORY > Repeater List > Simplex

Accessing repeaters

This section describes how to check whether or not you can access your local area repeater (Access repeater), and if your signal is successfully sent to a destination repeater.

TIP: If your call sign (MY) has not been set, or your call sign and equipment have not been registered at a D-STAR repeater, see pages 10-4, 10-5.

Step 1: Set "FROM" (Access repeater)

1. Select the operating band.
2. Hold down **CALLDR** for 1 second to display the DR screen.
3. Touch "FROM" to select, and then touch "FROM" again.



4. Touch "Repeater List."
5. Touch the repeater group where your access repeater is listed.
6. Touch your access repeater. (Example: Kirkland (IA))

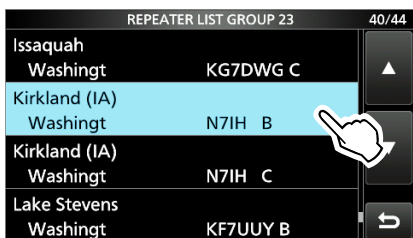

- Returns to the DR screen, and the selected repeater name is displayed in "FROM."
- ① By just selecting the repeater call sign, its frequency, duplex setting, and frequency offset are automatically set.
- ① A repeater list here is just an example.

TIP: There are several ways to set your access repeater. (p. 11-2)

- Rotating **MAIN DIAL** on the DR screen with "FROM" is selected
- Searching for the nearest repeater
- Setting from the TX History
- Searching for a repeater using the DR scan

Step 2: Set "TO" (Destination)

1. Touch "TO" twice.

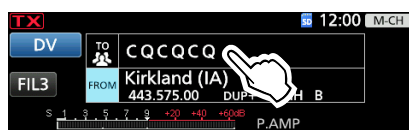

2. Touch "Gateway CQ."
3. Select the repeater group where your destination repeater is listed.
4. Select your destination repeater. (Example: Melbourne)



- Returns to the DR screen, and the selected repeater name is displayed in "TO."

Step 3: Check whether you can access the repeater

Push **TRANSMIT**, or hold down the microphone's [PTT] to transmit.

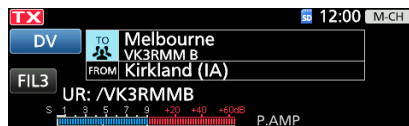

- If you get a reply call, or "UR?" is displayed within 3 seconds, your signal reached your access repeater and your call was successfully sent from your destination repeater.

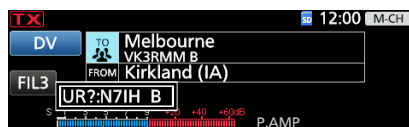

TIP: See "Troubleshooting" in the BASIC MANUAL for status indications after a reply is received.

Receiving

When a DV call is received, the call signs of the caller, the called station, and the called station's access repeater are saved in the RX History. Up to 50 calls can be saved.

Even if you turn OFF the transceiver, the RX History is retained.

This section describes how to display the RX History screen and how to save the call sign to your memory.

When receiving a call from "JM1ZLK":

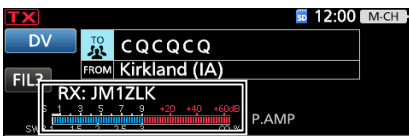

The S-meter and the caller's call sign are displayed.

Step 1: To display a received call sign

Open the RX HISTORY screen.

MENU » **CD**

- Rotate **MAIN DIAL** to confirm other RX history records.

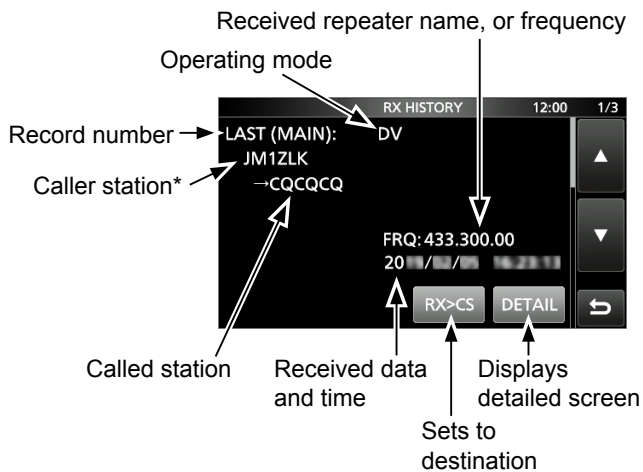

* The caller name is displayed when the name is set in "Your Call Sign" list.

Push **QUICK** to switch between name display and call sign display.

- ① "I" and a note may be displayed after the call sign.
- ① If a call is received from an area, not from a specific station, "CQCQCQ" is displayed.

Step 2: Save the destination call sign into your call sign memory from RX History

1. Rotate **MAIN DIAL** to select the RX history record with the call sign that you want to save to memory.
2. Touch [DETAIL].
3. Push **QUICK**.
4. Touch "Add To Your Memory."

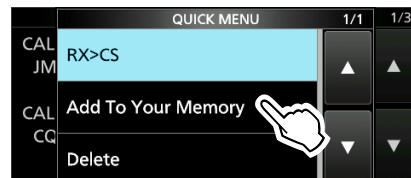

5. Touch the call sign that you want to save. (Example: "JM1ZLK")

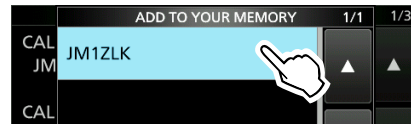

6. Touch "NAME."
7. Enter a name of up to 16 characters, then touch [ENT].

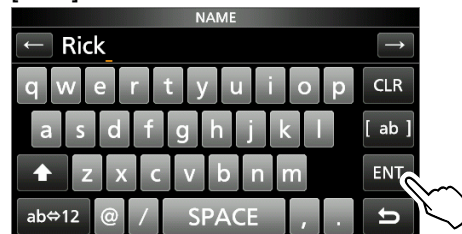

① See "Keyboard entering and editing" in the BASIC MANUAL for details.

8. Touch "<<Add Write>>."



9. Touch "YES."
 - Returns to the RX HISTORY DETAIL screen.
10. To close the RX HISTORY screen, push **EXIT** several times.

10. D-STAR OPERATION (BASIC)

Capturing a call sign

After you receive a signal, the calling station's call sign can be captured by holding down the Call Sign Capture key (**TONE<RX>CS**) for 1 second. After releasing, you can quickly and easily reply to the call.

What is the Call Sign Capture key?

Holding down the Call Sign Capture key for 1 second sets the last received station's call sign as a temporary destination, and makes replying quick and easy.

Step 1: Set the received call sign to "TO" (Destination)

While receiving, hold down **TONE<RX>CS** for 1 second.

- Announces the station call sign.



Information

- If you want to select another call sign in the RX History, push **TONE<RX>CS**, and then rotate **(MAIN DIAL)**.
- When a received signal is weak, or during a DV scan, the call sign may not be correctly received. In that case, you cannot capture the call sign.
- When "RX>CS SPEECH" is set to "OFF," the transceiver does not announce the call sign.

MENU » **SET > Function > SPEECH > RX>CS SPEECH**

Step 2: Hold down [PTT] to transmit

Push **TRANSMIT**, or hold down the microphone's [PTT] to transmit.

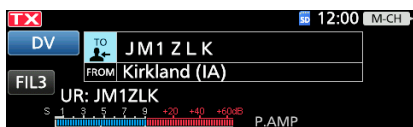

- Push **TONE<RX>CS** to return to the previous call sign setting.

TIP: The Local CQ call is used to call anyone, but you can call a specific station by simply saying their call sign.

Making a Local CQ call

You can make a Local CQ call when "Local CQ" is set to "TO" (Destination).

What is a Local CQ Call?

To call a CQ through only your local area (access repeater).

Step 1: Set "FROM" (Access repeater)

- Select the operating band.
- Hold down **CALLDR** for 1 second.
- Touch "FROM" to select, and then touch "FROM" again.



- Touch "Repeater List."
- Select the repeater group where your access repeater is listed.
- Touch your access repeater. (Example: Melbourne)



- Returns to the DR screen, and the selected repeater name is displayed in "FROM."

Step 2: Set "TO" (Destination)

- Touch "TO" twice.



- Touch "Local CQ."
 - Returns to the DR screen, and "CQCQCQ" is displayed in "TO."

Step 3: Hold down [PTT] to transmit

Push **TRANSMIT**, or hold down the microphone's [PTT] to transmit.

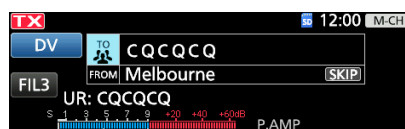

10. D-STAR OPERATION (BASIC)

Making a Gateway CQ call

You can make a Gateway CQ call when a destination repeater is selected in "TO" (Destination).

What is a Gateway CQ call?

- To call a CQ through a repeater connected to the Internet.
- You can call a CQ to the areas where you cannot directly access because the communication is routed through the Internet.

Step 1: Set "FROM" (Access repeater)

1. Select the operating band.
2. Hold down **CALLDR** for 1 second.
3. Touch "FROM" to select, and then touch "FROM" again.
4. Touch "Repeater List."
5. Select the repeater group where your access repeater is listed.
6. Touch your access repeater. (Example: Melbourne)
 - Returns to the DR screen, and the selected repeater name is displayed in "FROM."

Step 2: Set "TO" (Destination)

1. Touch "TO" twice.



2. Touch "Gateway CQ."
3. Select the repeater group where your destination repeater is listed.
4. Select your destination repeater. (Example: Inage)



- Returns to the DR screen, and the selected repeater name is displayed in "TO."

Step 3: Hold down [PTT] to transmit

Push **TRANSMIT**, or hold down the microphone's [PTT] to transmit.

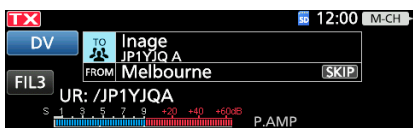

NOTE: If the selected Access repeater does not connect to the gateway, "**XGW**" is displayed. In that case, you cannot select "Gateway CQ."

Calling an individual station

You can make a call to an individual station when the station call sign is selected in "TO" (Destination). When you call an individual station through a gateway, your call is automatically sent to the last repeater that the station accessed. So, even if you don't know where the station is, you can make a call using Call Sign Routing.

Step 1: Set "FROM" (Access repeater)

1. Select the operating band.
2. Hold down **CALLDR** for 1 second.
3. Touch "FROM" to select, and then touch "FROM" again.
4. Touch "Repeater List."
5. Select the repeater group where your access repeater is listed.
6. Touch your access repeater. (Example: Melbourne)
 - Returns to the DR screen, and the selected repeater name is displayed in "FROM."

Step 2: Set "TO" (Destination)

1. Touch "TO" twice.



2. Touch "Your Call Sign."
3. Select your destination station. (Example: Rick)



- Returns to the DR screen, and the selected name is displayed in "TO."

Step 3: Hold down [PTT] to transmit

Push **TRANSMIT**, or hold down the microphone's [PTT] to transmit.

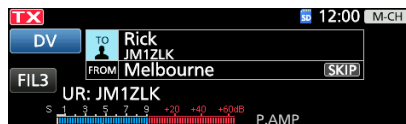

10. D-STAR OPERATION (BASIC)

Saving settings

When “FROM” (Access repeater) and “TO” (Destination) settings are saved, the settings can be selected by rotating **MULTI**.

Step 1: Saving settings into memory

1. On the DR screen, select the settings to be saved into memory.

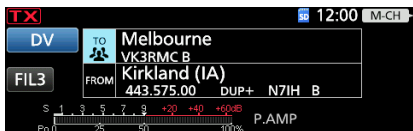

2. Push **QUICK**.
3. Touch “Memory Write.”

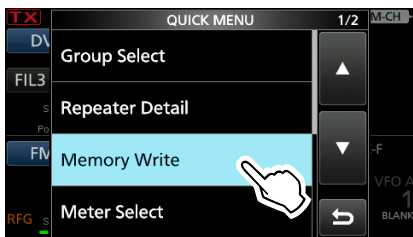

4. Touch the settings to be saved into memory. (Example: 1)



5. Touch “YES.”



- The operating data is saved into a blank channel. “FROM” and “TO” names are automatically entered as the Memory name. (Up to 16 alphanumeric characters.)

Step 2: View the saved contents

1. Hold down **CALLDR** for 1 second to cancel the DR screen.
2. Push **V/M** to enter the Memory mode.
3. Push **kHzM-CH**.
4. Rotate **MULTI** to select the saved channel. (Example: “1”)

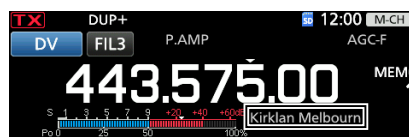

Memory name

TIP: Checking the Memory contents

You can check the Memory contents on the MEMORY LIST screen.

MENU » **MEMORY**

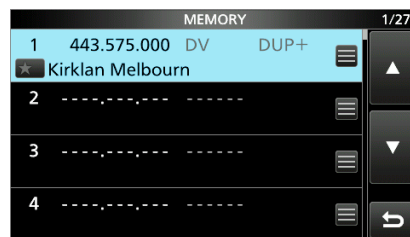

10. D-STAR OPERATION (BASIC)

Updating the repeater list

For easy operation, a repeater list is preloaded into your transceiver.

This section describes how to update the repeater list using an SD card.

You can download the repeater list from the Icom website.

NOTE: Before using an SD card, see Section 6 of the basic manual for details of a card.

TIP: The file name “9700_USA_yymmdd” is used as an example in the following instructions.

File Name: 9700_USA_yymmdd.zip

Depending on the transceiver version.

Depending on the updated file date.

Step 1: Downloading the repeater list

1. Access the following URL to download the data files.

<https://www.icomjapan.com/support/>

- The repeater list and GPS data (CSV: Comma Separated Values file) are contained in the downloaded ZIP file.

TIP: IC-9700's repeater list is uploaded to “Firmware/Software” in the Icom website.

① The displayed contents may differ.

Type	Model Name	ASC / DESC	Version	last update
Repeater List, GPS Data	IC-9700	Version *	20yy/mm/dd	

2. Decompress the file that is downloaded from the Icom website.

- “9700_USA_yymmdd” folder is created on the same place where the downloaded file is saved.

Step 2: Inserting the SD card into a PC

Turn OFF the transceiver, then remove the SD card from the transceiver. Insert it into the SD card drive or a memory card reader* on your PC.

*User supplied.

① To use the SD card with the transceiver, format the card using the transceiver, even preformatted for PCs or other uses.

See Section 6 of the basic manual for details.

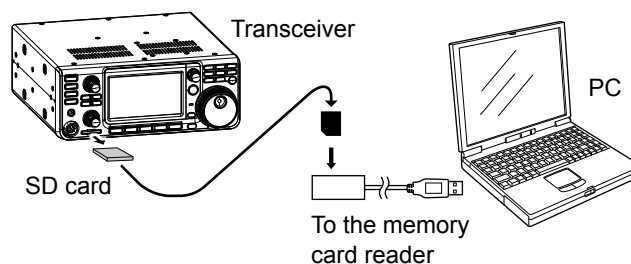

10. D-STAR OPERATION (BASIC)

Updating the repeater list

Step 3: Copying the CSV file to the SD card

1. Double-click the "9700_USA_yymmdd" folder created in the same place where the downloaded file is saved.
2. Copy the CSV file (Example: "9700_USA_Rpt_yymmdd.csv") in the folder and paste it in the "RptList" folder ("IC-9700" > "Csv" > "RptList") of the SD card.

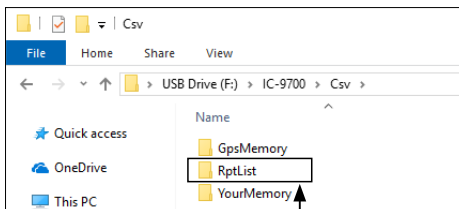
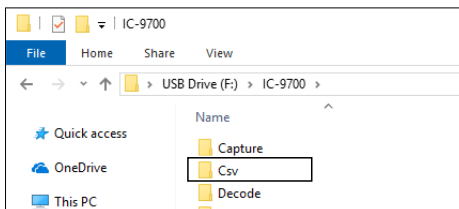
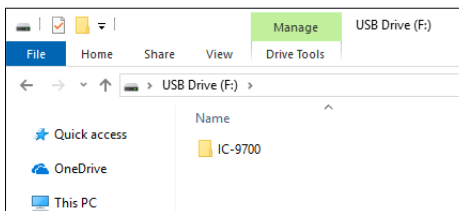

Paste the copied CSV file in this folder.

Step 4: Removing the SD card

Turn OFF the transceiver, then remove the SD card from your PC, and insert it into the transceiver's slot.

TIP: We recommends that you save the current data before loading other data into the transceiver.

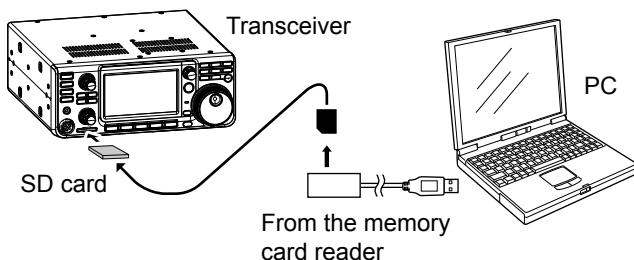

Step 5: Updating the repeater list

1. Open the IMPORT/EXPORT screen.
MENU » **SET > SD Card > Import/Export**

2. Touch "Import."



3. Touch "Repeater List."



4. Touch the CSV file to be loaded.
(Example: 9700_USA_Rpt_yymmdd)

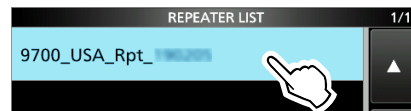

5. Touch [YES] or [NO].

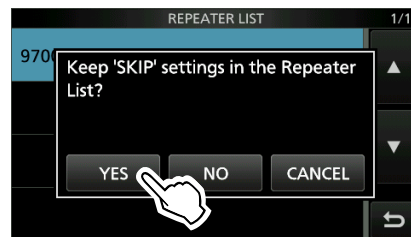

- YES: Retains the skip settings of the repeater list. (See page 11-26.)
- NO: Does not retain the skip settings of the repeater list.

6. Touch [YES].

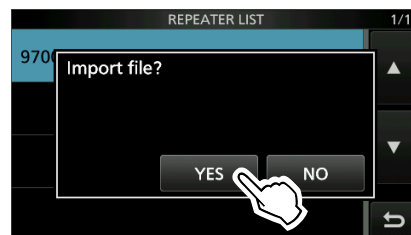

- Starts the import.
- After importing ends, "COMPLETED!" is displayed.

7. To complete the importing, reboot the transceiver.

TIP: If you copy the ICF file to the "Setting" folder of the SD card, the repeater list can be updated with the same procedures. In that case, select "Load Setting" on the SD CARD screen. And on the LOAD FILE screen, select "Repeater List Only."

MENU » **SET > SD Card > Load Setting**

“FROM” (Access repeater) setting

Set by rotating **MAIN DIAL:**
 Select a preset repeater by rotating **MAIN DIAL** on the DR screen.
 ⓘ You can also select the repeater by rotating **MULTI** after pushing **KHzM-CH**.

When you know your access repeater:

From the repeater list:
 When your access repeater is in your transceiver’s repeater list, you can select it by selecting the repeater area and name, if entered, or call sign.

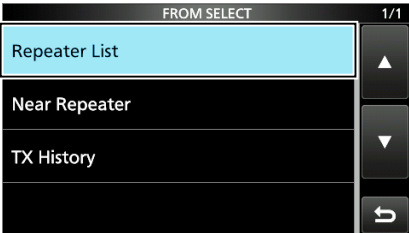

The screenshot shows a 'FROM SELECT' menu with '1/1' in the top right. The menu items are 'Repeater List' (highlighted in light blue), 'Near Repeater', and 'TX History'. On the right side, there are up and down arrow buttons and a return key.

When you do not know which repeater you can access:

Search for a repeater using the DR scan:
 The Normal DR scan searches for output repeater frequencies or simplex signals.
 You can also find FM repeaters.

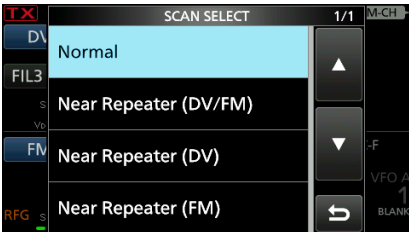

The screenshot shows a 'SCAN SELECT' menu with '1/1' and 'M-CH' in the top right. The menu items are 'Normal' (highlighted), 'Near Repeater (DV/FM)', 'Near Repeater (DV)', and 'Near Repeater (FM)'. On the right side, there are up and down arrow buttons and a return key.

Search for the nearest repeater:
 Searches for the nearest repeater by using your location and the repeater’s location if it is entered in the Repeater List.
 The nearest repeaters in your transceiver’s Repeater List are displayed as selectable choices.
 You can select a nearby repeater type (DV, FM, or DD).

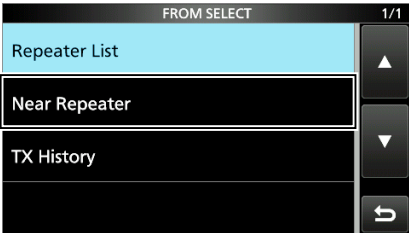

The screenshot shows a 'FROM SELECT' menu with '1/1' in the top right. The menu items are 'Repeater List', 'Near Repeater' (highlighted), and 'TX History'. On the right side, there are up and down arrow buttons and a return key.

When the “FROM” data is saved in the TX History:

Set from the TX History:
 Select a repeater that you have accessed before, from the TX History record.

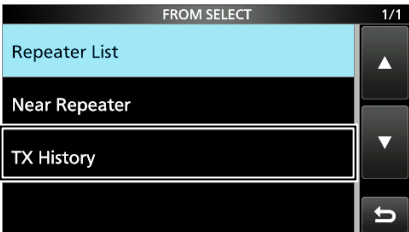

The screenshot shows a 'FROM SELECT' menu with '1/1' in the top right. The menu items are 'Repeater List', 'Near Repeater', and 'TX History' (highlighted). On the right side, there are up and down arrow buttons and a return key.

“TO” (Destination) setting

Set by rotating (MAIN DIAL):

Rotate (MAIN DIAL) to select a repeater or Your Call Sign that is displayed on the DR screen.
(This operation is disabled when “CQCQCQ” is set.)

TIP: After you receive the individual station or repeater’s signal, the call sign can be captured by holding down the Call Sign Capture key (TONE[RX-CS]), and you can quickly and easily reply to a call.

To make a Local Area CQ call:

Set “CQCQCQ” in “TO” (Destination).

To make a Gateway CQ call:

Select a repeater from the repeater list, if you want to make a Gateway call.

To make a call to a specific station:

Select the station call sign in the Your Call Sign.

To make a call through a reflector:

Select a reflector that is connected to the repeater you want to call through.

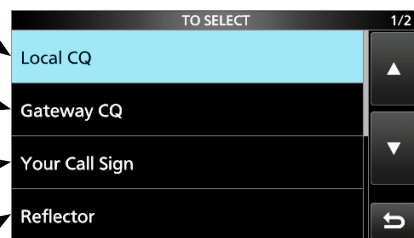

To select from RX History:

When you receive a call, the caller station data is saved in RX History. You can select the destination from the record.

To select from TX History:

When you make a call, the destination repeater or called station data is saved in TX History. You can select the destination from the record.

To directly enter the destination station call sign:

Directly enter the destination station’s call sign.

To directly enter the destination repeater call sign:

Directly enter the destination repeater’s call sign.

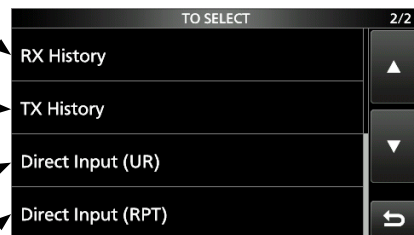

Section 11 D-STAR OPERATION (ADVANCED)

“FROM” (Access repeater) setting.....	11-2
◇ Using your transceiver’s repeater list	11-3
◇ Using the DR scan	11-4
◇ Using the Near Repeater Search function.....	11-5
◇ Using TX History.....	11-6
“TO” (Destination) setting	11-7
◇ Using the “Local CQ” (Local Area call).....	11-8
◇ Using the “Gateway CQ” (Gateway call)	11-8
◇ Using “Your Call Sign”	11-8
◇ Using RX History	11-9
◇ Using TX History.....	11-9
◇ Directly entering (UR).....	11-10
◇ Directly entering (RPT).....	11-10
REPEATER DETAIL screen	11-11
Connecting to a reflector	11-12
◇ What is a reflector?	11-12
◇ Using a reflector	11-12
◇ Linking to a reflector.....	11-13
◇ Unlinking a reflector.....	11-14
◇ Reflector Echo Testing.....	11-14
◇ Requesting repeater information	11-14
Message operation	11-15
◇ Entering a TX message	11-15
◇ Transmitting a message	11-15
◇ Deleting a TX message	11-15
Viewing received call signs	11-16
◇ Viewing the call signs on the RX History screen	11-16
DV Repeater Monitor function	11-18
BK mode communication.....	11-19
EMR communication	11-20
◇ Adjusting the EMR AF level.....	11-20
Automatic DV detection	11-21
Automatic Reply function.....	11-22
◇ Recording an Auto Reply message	11-23
◇ When receiving a position data	11-23
Data communication.....	11-24
◇ Connection	11-24
◇ Data communication application setting.....	11-24
◇ Sending data	11-24
◇ DV Fast Data function	11-25
Digital squelch functions.....	11-26
◇ The Digital Call Sign squelch setting.....	11-26
◇ The Digital Code Squelch setting.....	11-26
Repeater list	11-27
◇ Repeater list contents.....	11-27
Entering new information into the repeater list.....	11-28
◇ Required items for the communication cases	11-28
◇ Entering new information into the repeater list.....	11-29
◇ Editing repeater data	11-32
◇ Deleting repeater data.....	11-33
◇ Rearranging the display order of the repeaters.....	11-34
◇ Adding a new repeater information from RX History	11-34
◇ Skip setting for the DR scan.....	11-35
◇ Entering or editing a repeater group name.....	11-36
Your Call Sign.....	11-37
◇ Entering Your Call Sign	11-37
◇ Deleting Your Call Sign.....	11-38
◇ Rearranging the display order of Your Call Signs.....	11-38
Manually setting Call Signs	11-39
Are your settings correct?.....	11-40
Using the RS-MS1A.....	11-41
◇ Required items	11-41
◇ Installing the application.....	11-41
◇ Connecting the OPC-2350LU.....	11-41

11. D-STAR OPERATION (ADVANCED)

“FROM” (Access repeater) setting

Your Access repeater must be set in “FROM” when you make a call on the DR screen.
You have 5 ways to set the Access repeater.

By rotating **MAIN DIAL**

Select the preset repeater by rotating **MAIN DIAL** on the DR screen.

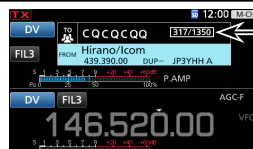

Displayed while rotating **MAIN DIAL**

• When you know your access repeater

From the repeater list (p. 11-3)

You can select your access repeater from the repeater list by selecting the repeater area and name, if entered, or call sign.

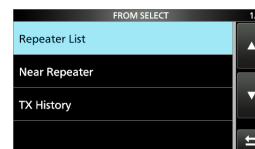

• When you do not know which repeater you can access

Search for a repeater using the DR scan (p. 11-4)

The Normal DR scan searches for output repeater frequencies of nearby repeaters. The scan stops when a signal is detected.

- The scan also stops on Simplex signals.

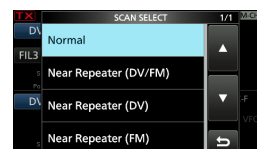

Scan items

The Near Repeater scan searches for output repeater frequencies of nearby repeaters that are within 160 kilometer (100 miles) from your position and the repeater's position that is entered in the repeater list. The DR scan starts scanning and stops when a signal is detected.

You can also find only FM repeaters using the Near Repeater (FM) scan.

Search for near repeaters (p. 11-5)

Searches for near repeaters that are within 160 kilometer (100 miles) from your position using your GPS position and the repeater's position that is entered in the repeater list.

The nearest repeaters in your transceiver's repeater list are displayed as selectable options.

You can select the nearby DV only, FM only, or both repeater types.

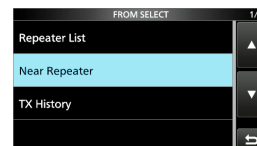

• When “FROM” data is saved in the TX History.

From the TX History (p. 11-6)

Select a repeater that you have accessed before from the TX History.

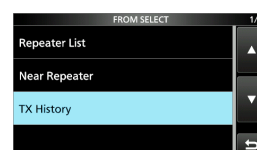

11. D-STAR OPERATION (ADVANCED)

“FROM” (Access repeater) setting

◇ Using your transceiver’s repeater list

When your access repeater is in your transceiver’s repeater list, you can select it from the list. By just selecting the repeater from the list, the repeater call sign, its frequency, duplex setting, and frequency offset are automatically set, for easy operation.

Example: Selecting the “Kirkland (IA)” repeater in Washington, USA from the repeater list.

1. Select the operating band. (Example: 430 MHz)
2. Hold down **CALL/DR** for 1 second to display the DR screen.
3. Touch **[FROM]** to select “FROM.”
4. Touch **[FROM]**.



5. Touch “Repeater List.”
6. Select the repeater group where your access repeater is listed.
7. Select your access repeater.

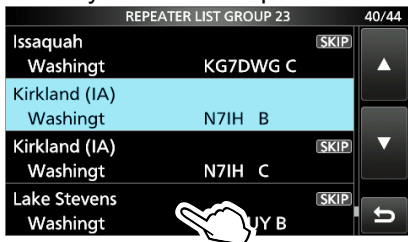

- Returns to the DR screen, and the selected repeater name, frequency, and call sign are displayed in “FROM.”
- ⓘ The repeater list, described in this manual, may differ from your transceiver’s preloaded contents.

TIP:

When you select an FM repeater:

When an FM repeater is in your transceiver’s repeater list, you can select it from the list. When selecting an FM repeater, the “TO” setting is not necessary and a “---” is displayed in “TO.”

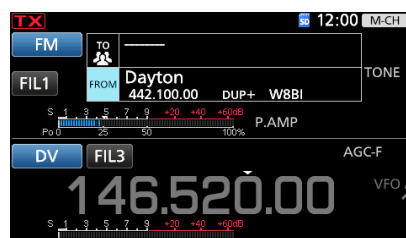

When selecting an FM repeater.

How to change the repeater group:

To change the repeater group on the DR screen, push **QUICK**, then select “Group Select.”

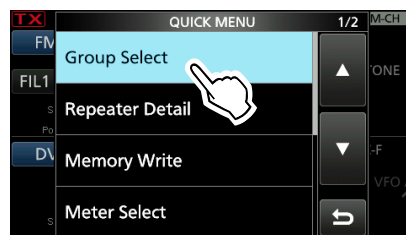

11. D-STAR OPERATION (ADVANCED)

“FROM” (Access repeater) setting

◇ Using the DR scan

The DR scan scans frequencies to find a signal on a repeater, or on a simplex frequency.

You can use 2 kinds of DR scans, Normal scan and Near Repeater scan.

Normal scan

To quickly find a repeater, the Normal scan skips repeaters that are not set as an access repeater.

① The “USE (FROM)” setting is set to “NO” on the repeater list.

(MENU > DV/DD Memory > **Repeater List**)

Near Repeater scan

The Near Repeater scan searches for up to 20 nearby repeaters by using your position and the repeater’s entered position, and then lists the repeaters.

① The Near Repeater scan continues, even if you turn OFF the transceiver, and then turn it ON again during the scan.

② If your own position data is not being received from GPS satellites, the last received position is used.

NOTE: Even if your transceiver receives a repeater signal, the repeater may not receive your signal, because the repeater’s output power is higher than your transceiver’s, and your signal does not reach the repeater.

TIP: The DR scan scans the simplex frequencies in the repeater list, in addition to D-STAR repeaters.

Example: Selecting an active repeater using the DR scan.

1. Select the operating band. (Example: 430 MHz)
2. Hold down **CALLDR** for 1 second to display the DR screen.

3. Touch [FROM] to select “FROM.”



4. Push **SCAN**.
 - Displays the SCAN SELECT window.
 5. Rotate [DIAL] to select the scan type.
 - Normal: Searches for repeaters whose “USE (FROM)” setting is set to “YES.”
 - Near Repeater (DV/FM): Searches for up to 20 nearby DV or FM repeaters. (Total 40 repeaters)
 - Near Repeater (DV): Searches for up to 20 nearby DV repeaters.
 - Near Repeater (FM): Searches for up to 20 nearby FM repeaters.
 - The selected scan starts.
 - In the DR scan, the repeaters are sequentially displayed by distance, in descending order.
- ① The scan resumes the same as other scans.



Blinks

← The repeaters are sequentially displayed.

6. When the transceiver receives a signal from a repeater, the scan stops. Push **SCAN**.

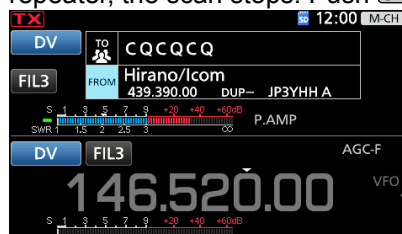

- The DR scan is canceled, and the repeater is set to “FROM.”

“FROM” (Access repeater) setting

◇ Using the Near Repeater Search function

The transceiver searches for the nearest repeaters by using your position and the repeater’s entered position.

The nearest repeaters in your transceivers’ repeater list are displayed as selectable options.

NOTE:

- When using the Near Repeater Search function, BE SURE to first receive your own GPS position data, or manually enter your position data.
- If no repeater is found within a 160 kilometer (100 miles) range, “No Repeater Found” is displayed.
- If the last received position can be used, “GPS is invalid. Search by last valid position” is displayed.

Example: Selecting a nearby repeater from the Near Repeater list.

Step 1: Receiving your own position from the GPS satellite

Confirm the GPS receiver is receiving your position.

- The GPS icon blinks when searching for satellites.

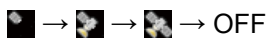

- The GPS icon stops blinking when the minimum needed number of satellites is found.



- ① It may take only a few seconds to receive, or it may take a few minutes, depending on your operating environment. If you have difficulties receiving, we recommend that you try a different position.
- ① If your own position is not being received, the last received position is used for your location.
- ① If the “GPS Select” item is set to “Manual,” the GPS icon is not displayed.

Step 2: Selecting the Access repeater from the Near Repeater list

1. Select the operating band. (Example: 430 MHz)
2. Hold down **CALL/DR** for 1 second to display the DR screen.
3. Touch **[FROM]** to open the FROM SELECT screen.



4. Touch **[Near Repeater]**.
5. Select the type of nearby repeater to display.
 - Near Repeater (ALL): Displays up to 20 nearby DV and FM repeaters. (A total 40 repeaters)
 - Near Repeater (DV): Displays up to 20 nearby DV repeaters.
 - Near Repeater (FM): Displays up to 20 nearby FM repeaters.
 - Near Repeater (DD): Displays up to 20 nearby DD repeaters.
6. Select the repeater to use as your access repeater, considering the distance from your position to the repeater.

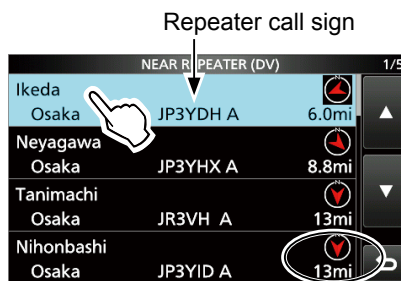

Repeater call sign

Distance and direction from your position to the repeater*

* When the “POSITION” setting (p. 8-41) is set to “Approximate” on the repeater list, the direction data is not displayed if the distance to the repeater is less than 5 kilometers.

(MENU > DV/DD MEMORY > **Repeater List**)

- Returns to the DR screen, and the selected repeater is set in “FROM.”

11. D-STAR OPERATION (ADVANCED)

“FROM” (Access repeater) setting

◇ Using TX History

The TX History saves up to 10 of the latest Access (From) repeaters you transmitted on. You can select a repeater from TX History as your Access repeater.

Example: Selecting the “Hirano” repeater from TX History.

TIP: When you push **QUICK** in step 6, you can display the REPEATER DETAIL screen, or delete the repeater information from the TX HISTORY screen.

1. Select the operating band. (Example: 430 MHz)
2. Hold down **CALLDR** for 1 second to display the DR screen.
3. Touch **[FROM]** to open the FROM SELECT screen.

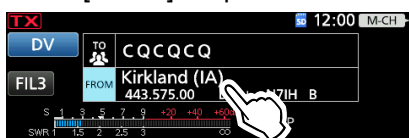

4. Touch “TX History.”

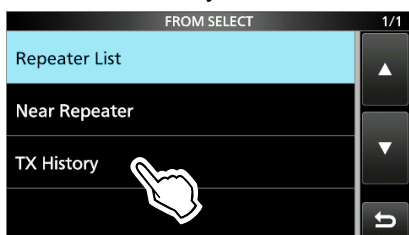

5. Touch the TX History type.

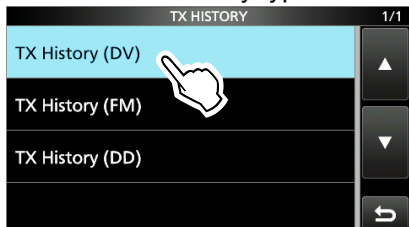

- TX History (DV): Displays the TX History of the DV repeaters.
- TX History (FM): Displays the TX History of the FM repeaters.
- TX History (DD): Displays the TX History of the DD repeaters.

6. Select the repeater to use it as your Access repeater.

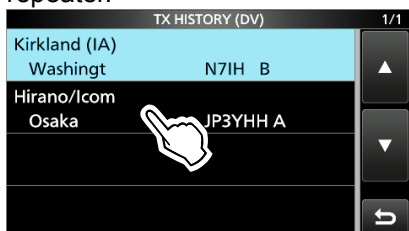

- Returns to the DR screen, and the selected repeater is set in “FROM.”

“TO” (Destination) setting

“CQCQCQ,” a destination repeater, or a station call sign must be set in “TO” when you make a call in the DV mode. You have 8 ways to set “TO” (destination).

TIP: After you receive the individual station or repeater’s signal, the call sign can be captured by holding down the Call Sign Capture key (**TONE****RX-CS**), and you can quickly and easily reply to a call.

By rotating **MAIN DIAL**

Rotate **MAIN DIAL** to select the repeater or Your Call Sign that is displayed on the DR screen. (This operation is disabled when “CQCQCQ” is set.)

• **To make a Local Area CQ call**

“Local CQ” setting (p. 11-8)
Set “CQCQCQ” in “TO” (Destination).

• **To make a Gateway CQ call**

“Gateway CQ” setting (p. 11-8)
Select a repeater from the repeater List, if you want to make a Gateway call.

• **To make a call to a specific station**

“Your Call Sign” setting (p. 11-8)
Select the station call sign in the Your Call Sign memory.

• **To make a call through a Reflector**

“Reflector” setting (p. 11-12)
Select a reflector you want to call through.

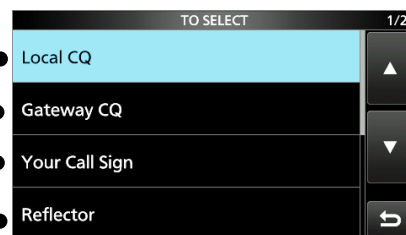

• **To select from RX History**

Setting from RX History (p. 11-9)
When you receive a call, repeater or caller station data is saved in RX History. Select the destination from the record.

• **To select from TX History**

Setting from TX History (p. 11-9)
When you make a call, the destination repeater or called station data is saved in TX History. Select the destination from the record.

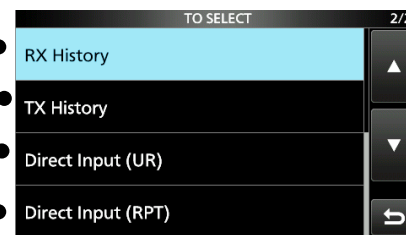

• **To directly enter the destination station call sign**

Direct Input (UR) (p. 11-10)
Directly enter the destination station’s call sign.

• **To directly enter the destination repeater call sign**

Direct Input (RPT) (p. 11-10)
Directly enter the destination repeater’s call sign.

11. D-STAR OPERATION (ADVANCED)

“TO” (Destination) setting

◇ Using the “Local CQ” (Local Area call)

When “Local CQ” is selected on the TO SELECT screen, “CQCQCQ” is set in “TO.”

Example: Making a Local area call by accessing the “Kirkland (IA)” repeater.

1. Touch “TO” to select, then open the TO SELECT screen.



2. Touch “Local CQ.”
 - Returns to the DR screen, and “CQCQCQ” is set in “TO.”

◇ Using the “Gateway CQ” (Gateway call)

When “Gateway CQ” is selected on the TO SELECT screen, you can select the repeater to make a gateway call on the repeater list.

Example: Making a Gateway CQ call to the “Issaquah” repeater from the “Kirkland (IA)” repeater.

1. Touch “TO” to select, then open the TO SELECT screen.

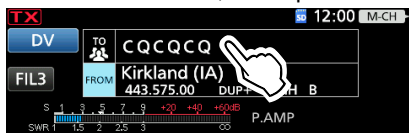

2. Touch “Gateway CQ.”
3. Touch the repeater group where your destination repeater is listed.
4. Touch the destination repeater.
 - Each repeater has a correct node (A, B, or C band) that you want to transmit on. See page 11-29, “NOTE” for band letter details.



(Example: “23: USA West”)

- Returns to the DR screen, and “Issaquah” is set in “TO.”

◇ Using “Your Call Sign”

The “Your Call Sign” memory saves individual or repeater station call signs. When you select the call sign for the “TO” (Destination) setting, you can make a Gateway call. When you call an individual station through a gateway, the signal is automatically sent to the last repeater that the individual station accessed. Therefore, even if you do not know where the individual station is located, you can make a call.

NOTE: If the repeater, set in “FROM” (Access repeater) has no Gateway call sign, you cannot make a gateway call.

Example: Selecting “Rick” from “Your Call Sign.”

1. Touch “TO” to select, then open the TO SELECT screen.



2. Touch “Your Call Sign.”
3. Touch a destination name or call sign.

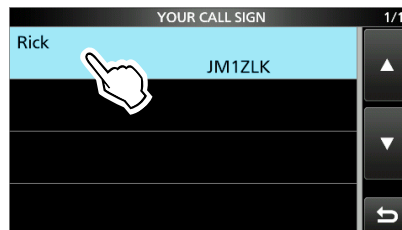

- Returns to the DR screen, and “Rick” is set in “TO.”

TIP: After selecting a destination repeater or station, you can select another repeater or station preset in your transceiver by rotating **(MAIN DIAL)**.

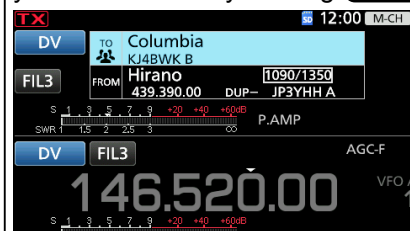

11. D-STAR OPERATION (ADVANCED)

“TO” (Destination) setting

◇ Using RX History

When a call is received in the DV mode, the call data is saved in the RX History. Up to 50 callers, and only the last called call signs, for a total of 51 histories can be saved.

Example: Selecting “Rick” in the RX History.

1. Touch “TO” to select, then open the TO SELECT screen.

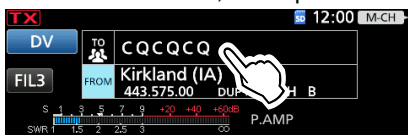

2. Touch “RX History.”
3. Touch a destination name or call sign.

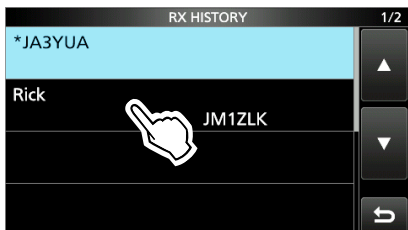

- Returns to the DR screen, and “Rick” is displayed in “TO.”

◇ Using TX History

TX History saves the repeater and station name and call sign of up to 20 “TO” (Destination) settings that were used when you made the calls.

NOTE: Until you make a call in the DV mode, you cannot select “TO” (destination) from the TX History.

Example: Selecting the “Melbourne” repeater in the TX History.

1. Touch “TO” to select, then open the TO SELECT screen.



2. Touch “TX History.”
3. Touch a destination repeater.

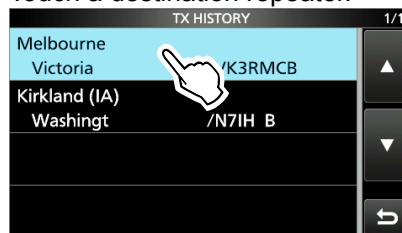

- Returns to the DR screen, and “Melbourne” is displayed in “TO.”

TIP: To add RX HISTORY data to a “Your Call Sign” memory, push **QUICK**, then select “Add To Your Memory.”

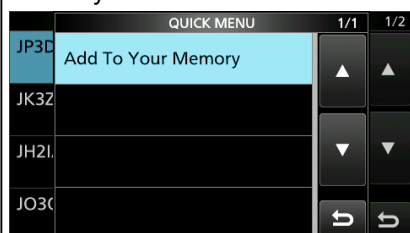

TIP: You can add the TX HISTORY data to memory, or delete it from the TX HISTORY screen. Push **QUICK**, then select the option.

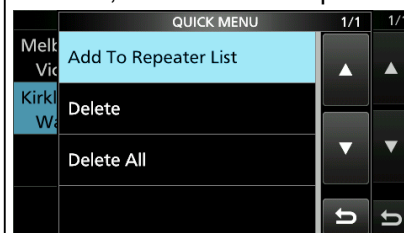

11. D-STAR OPERATION (ADVANCED)

“TO” (Destination) setting

◇ Directly entering (UR)

The destination station call sign can be directly entered.

Example: Directly entering the call sign “JM1ZLK.”

1. Touch “TO” to select, then open the TO SELECT screen.



2. Touch “Direct Input (UR).”
3. Enter the station’s call sign of up to 8 characters, including spaces.

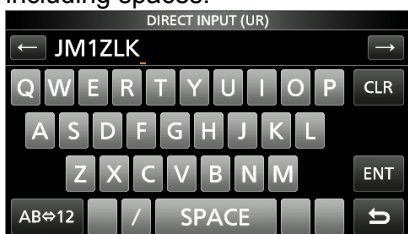

4. After entering, touch [ENT].
 - Returns to the DR screen, and “JM1ZLK” is set in “TO.”
 - ① After entry, you can correct the call sign in the DIRECT INPUT (UR) screen.
 - ① The entered call sign remains on the DIRECT INPUT (UR) screen, until you enter a new call sign.

◇ Directly entering (RPT)

The destination repeater call sign can be directly entered.

NOTE: BE SURE to include a “/” at the beginning and the node letter as the 8th digit. See page 11-29 “NOTE” about the node letters.

Example: Directly entering the call sign “/JP3YDHA.”

1. Touch “TO” to select, then open the TO SELECT screen.

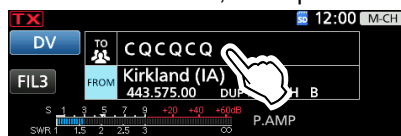

2. Touch “Direct Input (RPT).”
3. Enter a repeater call sign of up to 8 characters, including spaces.



4. After entering, touch [ENT].
 - Returns to the DR screen, and “/JP3YDHA” is set in “TO.”
 - ① After entry, you can correct the call sign in the DIRECT INPUT (RPT) screen.
 - ① The entered call sign remains on the DIRECT INPUT (RPT) screen, until you enter a new call sign.

TIP: If the entered call sign has a duplicate in the “Your Call Sign” memory, the name is displayed. (Only when the name has been entered.)

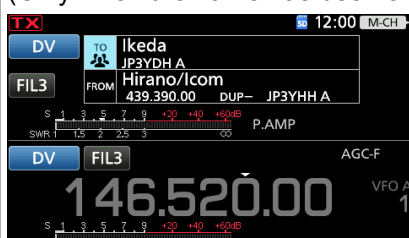

REPEATER DETAIL screen

Depending on the content, such as position data or UTC offset, the distance between your position and the repeater or the repeater time can be displayed on the REPEATER DETAIL screen.
 The detail screen can also be entered from the FROM SELECT screen.

Example: Displaying the “Hirano” repeater detail screen

1. Touch “TO” to select, then open the TO SELECT screen.



2. Touch “Gateway CQ.”
3. Touch “11: Japan.”
4. Touch “Hirano” for 1 second.
5. Touch “Detail.”

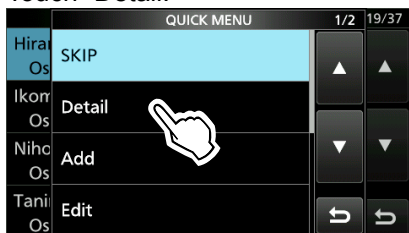

6. Push **EXIT** to return to the Repeater List screen.
- ① If there is no position data, the distance and direction from your position are not displayed. See page 8-2 to confirm your position.
 ② When selecting the FM repeater, either of “FM” or “FM-N” and the tone setting are displayed.

The REPEATER DETAIL screen

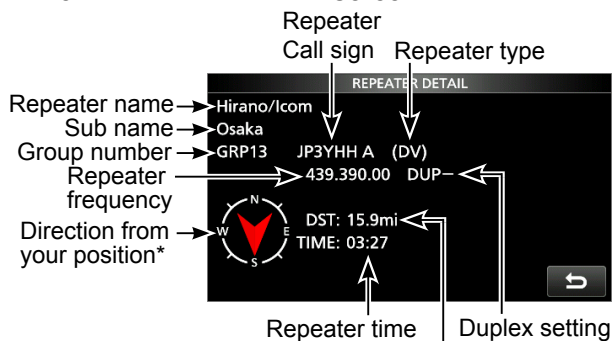

* When the “POSITION” setting (p. 11-31) is set to “Approximate” on the repeater list, the direction data is not displayed if the distance to the repeater is less than 5 kilometers.

TIP: You can display the REPEATER DETAIL screen when the DR screen is displayed. When you set the repeater as shown below, push **QUICK**, then select “Repeater Detail.”

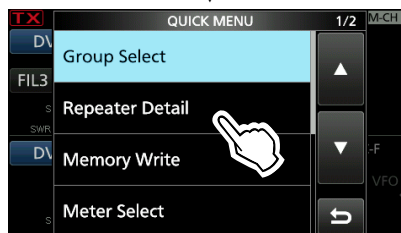

- Displays the REPEATER DETAIL screen.

Connecting to a reflector

◇ What is a reflector?

A reflector is a special server connected to the Internet and running a version of the D-Plus software. If the D-Plus software is installed on your Access repeater, it provides various functions including gateway and reflector linking capabilities (It is known as the D-STAR reflector system). The D-STAR reflector system enables a number of D-STAR repeaters anywhere to link to a reflector. This means that when you transmit through a D-STAR repeater linked to a reflector, your voice can be heard on other repeaters linked to the reflector, and you can hear other stations that are connected to the reflector.

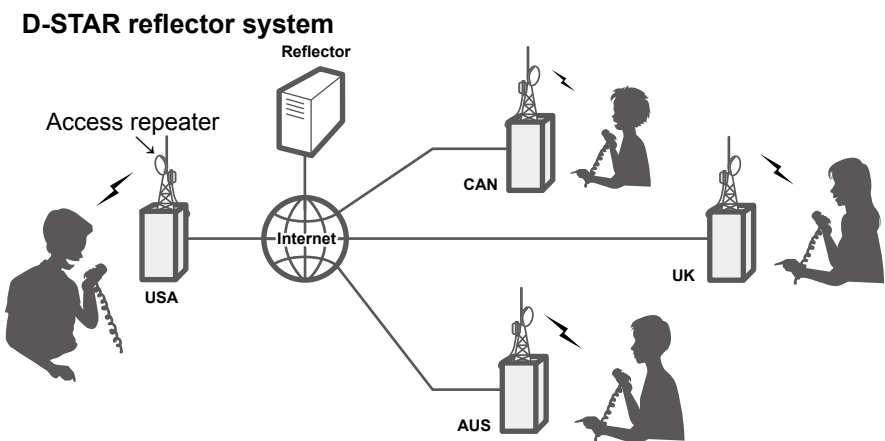

◇ Using a reflector

1. Touch "TO" to select, then open the TO SELECT screen.

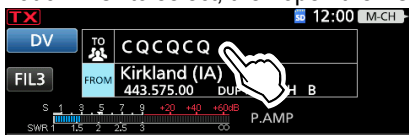

2. Touch "Reflector."

 - Displays the REFLECTOR screen.

3. Touch "Use Reflector."

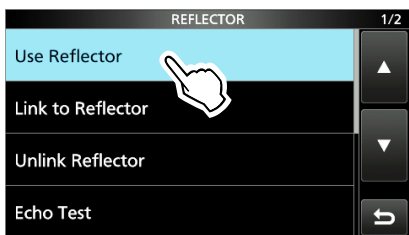

- Returns to the DR screen, and "Use Reflector" and "CQCQCQ" are set in "TO."

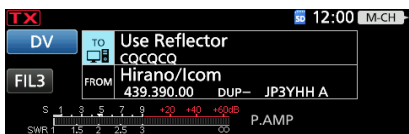

4. Push **[TRANSMIT]**, or hold down the microphone's **[PTT]** to transmit.

11. D-STAR OPERATION (ADVANCED)

Connecting to a reflector

◇ Linking to a reflector

If your repeater is not currently linked to a Reflector, or if you want to change it to another Reflector, follow the steps below. Before linking to another Reflector, BE SURE to unlink the current Reflector. (p. 11-14)

Direct inputting a Reflector

Example: Directly enter “REF010BL.”

1. Touch “TO” to select, then open the TO SELECT screen.



2. Touch “Reflector.”
3. Touch “Link to Reflector.”



4. Touch “Direct Input.”
5. Touch the number item, then rotate **(MAIN DIAL)** to select the reflector number and module letter, then touch [SET].

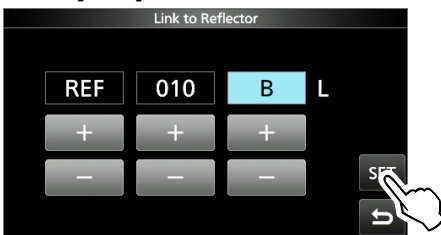

- Returns to the DR screen, and “Link to Reflector” and “REF010BL” are set in “TO.”

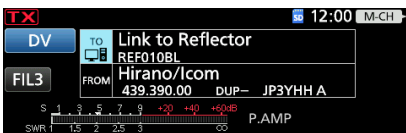

6. Push **(TRANSMIT)**, or hold down the microphone’s [PTT] to link to the Reflector.

Using TX History

TX History saves up to 5 reflectors that your Access repeater linked to before.

Example: Select the “REF010BL” in TX History.

1. Touch “TO” to select, then open the TO SELECT screen.

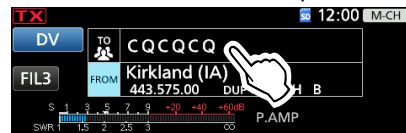

2. Touch “Reflector.”
3. Touch “Link to Reflector.”



4. Touch the reflector that you want to link to.

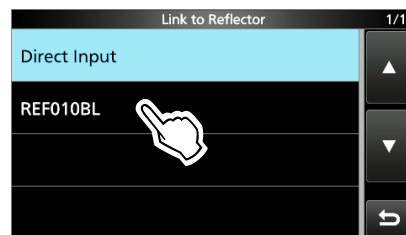

- Returns to the DR screen, and “Link to Reflector” and “REF010BL” are set in “TO.”



5. Push **(TRANSMIT)**, or hold down the microphone’s [PTT] to link to the reflector.

11. D-STAR OPERATION (ADVANCED)

Connecting to a reflector

◇ Unlinking a reflector

Before trying to link to another reflector, BE SURE to unlink the current connected reflector.

1. Touch "TO" to select, then open the TO SELECT screen.



2. Touch "Reflector."
3. Touch "Unlink Reflector."



- Returns to the DR screen, and "Unlink Reflector" and "U" are set in "TO."

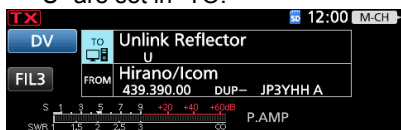

4. Push **TRANSMIT**, or hold down the microphone's [PTT] to unlink the reflector.

◇ Reflector Echo Testing

To confirm that your signal is correctly getting into the repeater, you can transmit a short message as a trial. After stopping transmission, your message will be played back.

1. Touch "TO" to select, then open the TO SELECT screen.

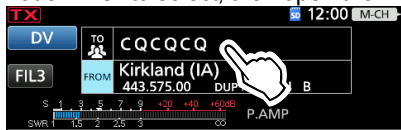

2. Touch "Reflector."
3. Touch "Echo Test."



- Returns to the DR screen, and "Echo Test" and "E" are displayed in "TO."

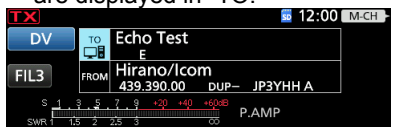

◇ Reflector Echo Testing

4. Push **TRANSMIT**, or hold down the microphone's [PTT] and speak into the microphone.
5. Stop transmitting to hear your message.

◇ Requesting repeater information

When you send the repeater information command, an ID message is sent back.

1. Touch "TO" to select, then open the TO SELECT screen.



2. Touch "Reflector."
3. Touch "Repeater Information."



- Returns to the DR screen, and "Repeater Information" and "I" are set in "TO."



4. Push **TRANSMIT**, or hold down the microphone's [PTT] to transmit the repeater Information command.
5. Stop transmitting to hear the repeater ID message.

NOTE: If a reflector is already connected, ask on the air whether or not you can change reflectors and wait for responses. BE SURE to reconnect back to the same reflector when you finish your conversation.

Message operation

You can save up to 5 short messages in the transceiver's memory to transmit in the DV mode. Each message can be up to 20 characters.

◇ Entering a TX message

Example: Entering "JAPAN TOM" into TX message memory number 1.

1. Open the TX MESSAGE (DV) screen.
MENU » **SET > My Station > TX Message (DV)**
2. Touch a TX message memory number for 1 second.

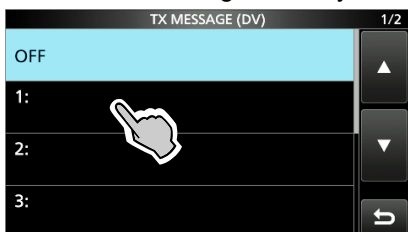

3. Touch "Edit."

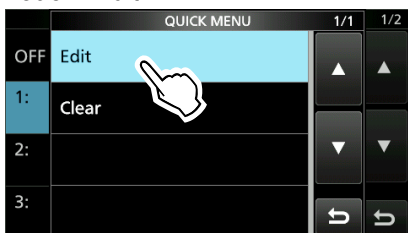

4. Enter a message of up to 20 characters, then touch [ENT].

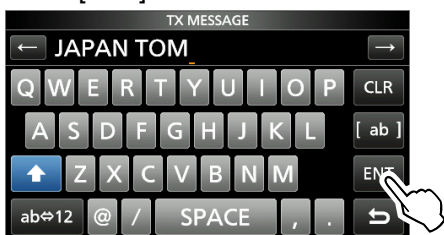

Selectable characters and symbols

A to Z, a to z, 0 to 9, ! " # \$ % & ' () * + , - . / : ; < = > ? @ [\] ^ _ ` { | } ~ (space)

- Returns to the TX MESSAGE (DV) screen.
5. To close the TX MESSAGE (DV) screen, push **EXIT**.

◇ Transmitting a message

You can transmit a preset TX message by pushing [PTT] in the DV mode. First, select a TX message which also turns ON the Message Transmission function.

1. Open the TX MESSAGE (DV) screen.
MENU » **SET > My Station > TX Message (DV)**
2. Touch a TX message memory number.

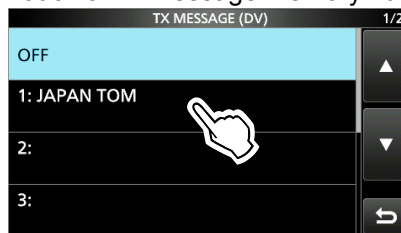

- ① To not transmit any message, select "OFF."
3. To close the TX MESSAGE (DV) screen, push **EXIT**.

① Information

- The message is transmitted with your voice signal.
- The message is transmitted each time you transmit.
- When continuously transmitting, the selected TX message is transmitted every 30 seconds.

◇ Deleting a TX message

You can delete the TX messages.

Example: Deleting TX message "JAPAN TOM" from TX message memory number 1.

1. Open the TX MESSAGE (DV) screen.
MENU » **SET > My Station > TX Message (DV)**
2. Touch a TX message memory number for 1 second.

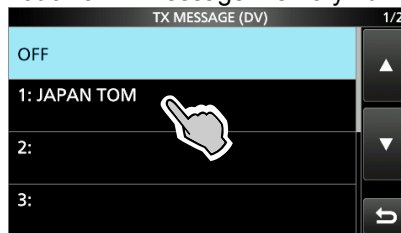

3. Select "Clear."

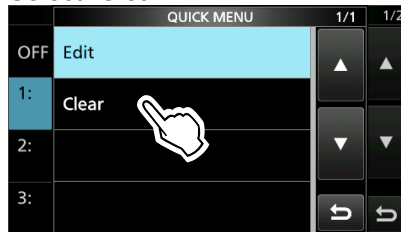

- The confirmation dialog is displayed.
4. Touch <YES>.
 - Clears the entered message.
- ① To exit the MENU screen, push **MENU**.

Viewing received call signs

When you receive a DV call, the calling station and the repeater call signs are saved. Up to 50 calls can be saved. When you receive the 51st call, the oldest history is deleted.

① Even if the transceiver is turned OFF, the RX record is not deleted.

◇ Viewing the call signs on the RX History screen

1. Open the RX HISTORY screen.

MENU » **(2) > CD**

2. Touch an RX history memory to view the details.

① Information

- The RX history number, the caller's name (or call sign), destination, RX message, RX date and time, "GW," and "GPS" are displayed.
- "GW" is displayed when a Gateway call is received.
- "GPS" is displayed when the received call includes position data.
- "UP" is displayed when a repeater uplink signal is received.
- In the Quick Menu, you can select the following options.

- RX>CS:** Temporarily sets the call sign into TO.
- Call Sign Display:** The received data is displayed in the Call Sign Display mode.
- Name Display:** The received data is displayed in the Name Display mode.
- Add to RPT List:** Adds the repeater's call sign to the **Repeater List**.
- Add to Your Memory:** Adds the caller station's call sign to **Your Call Sign**.
- Delete:** Deletes the selected RX history.

RX HISTORY screen (RX01)

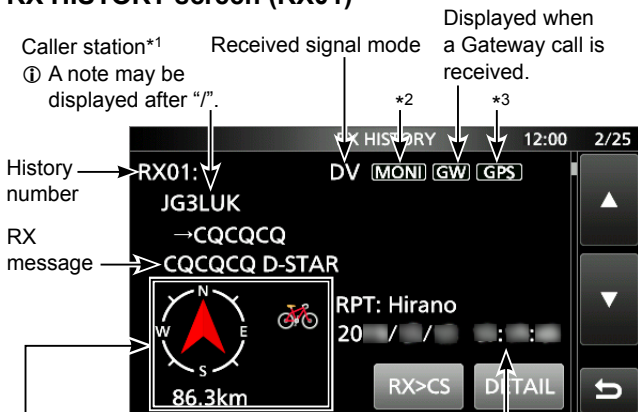

- D-PRS information
- Compass direction
 - Distance
 - D-PRS symbol

Received date and time

- *1 When a name is not entered in the DV Memory, the call sign is displayed.
- *2 The icon differs, depending on how the signal is received.
 - (No icon): The Normal mode (RF)
 - TM: The Terminal mode
 - MONI: The DV Repeater Monitor function
- *3 The icon differs, depending on the D-PRS TX format.
 - GPS: Position
 - OBJ: Object
 - ITEM: Item
 - WX: Weather

3. Touch [DETAIL].

- Displays the RX history detail screen.
- Rotate **(MAIN DIAL)** to select the page.

<1st page>

- **CALLER:** Displays the caller station's name*2 and any note entered after the call sign.
- **CALLED:** Displays the called station's name*2.
 - ① "CQCQCQ" is displayed when receiving a Local Area call or Gateway call.

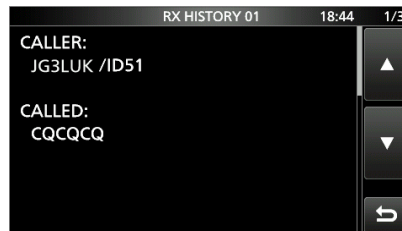

<2nd page>

- **RXRPT1:** Displays the repeater's name*2 that was accessed by the caller station. If the received call was a Gateway call, this item displays the gateway call sign of the repeater you received the call from.
- **RXRPT2:** Displays the repeater's name*2 you received the call from.

① The operating frequency is displayed instead of above items when the call was not through a repeater (Simplex call).



▶ Continued on the next page

11. D-STAR OPERATION (ADVANCED)

Viewing received call signs

◇ View the call signs on the RX History screen

<3rd page>

- **RX MESSAGE:** Displays any message included in the received call, if entered.
- **RX TIME:** Displays the date and time the call was received.



<4th, 5th page>

Displays position data of the caller station. If a received signal has no data, then no position data is displayed.



4. To close the RX HISTORY screen, push **EXIT**.

TIP: To delete RX HISTORY data
On the RX HISTORY or the detail screen, push **QUICK**, then touch “Delete” or “Delete All.”

QUICK MENU 1/1 2/31

RX0
JP
CC
W
Y

Detail

Call Sign Display

Delete

Delete All

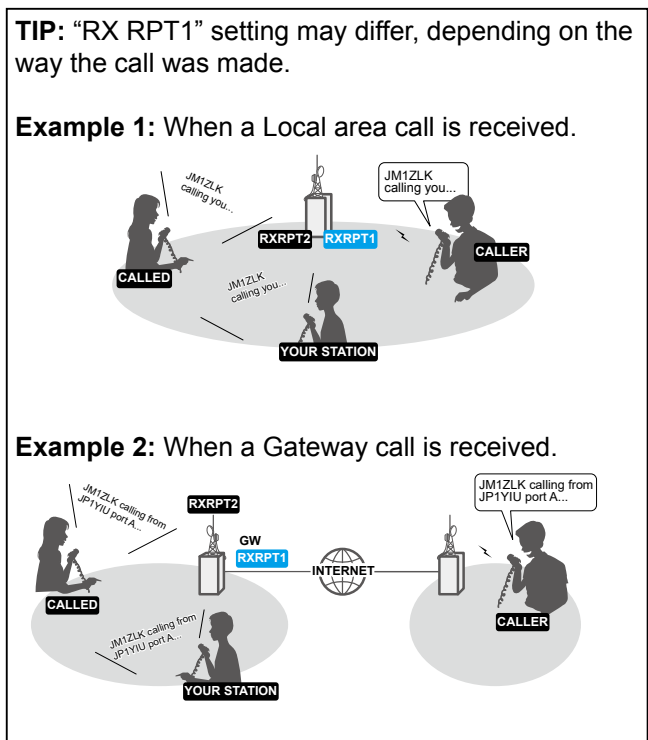

DV Repeater Monitor function

You can monitor a repeater that is selected in “TO” (Destination) through the Internet. While monitoring, you can receive a signal from an access repeater that is selected in “FROM.”

① Information

- You need an SD card and an Internet connection to use the DV Repeater Monitor function.
- You can use this function while displaying the DR screen or in the Terminal mode, and the DV repeater is selected.
- Only the repeater that is set in the Main band can be monitored.
- Some repeaters cannot be monitored.

Example: Station A and B are communicating through a repeater.

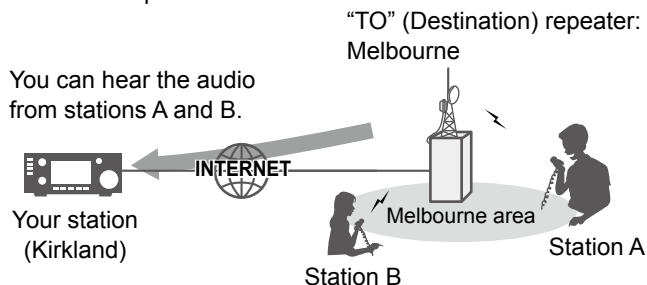

Step 1. Save the DV repeater’s IP address list file to the SD card (PC)

1. Download the IP address list file (Example: RepMoni_sample.csv) from the Icom website. <https://www.icomjapan.com/support/>
2. Copy a file into the “IC-9700” > “RptMoni” folder on the SD card.

Step 2. Select the IP address list file to use (Transceiver)

1. Insert the SD card into the transceiver.
2. Open the “Connection IP Address List” screen.

MENU » **SET > DV Repeater Monitor Set > Connection IP Address List**

3. Touch a file to use.

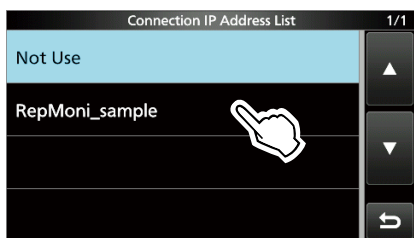

4. To close the DV REPEATER MONITOR SET screen, push **EXIT** several times.

Step 3. Connect to the Internet (Transceiver)

Connect the transceiver to the Internet by using a LAN cable.

- ① See the Basic Manual for details of the Network settings.

Step 4. Set “TO” (Destination repeater) (Transceiver)

1. Hold down **CALLDR** for 1 second to display the DR screen.
2. Touch “FROM” to set your access repeater.
3. Touch “TO” to set a repeater that you want to monitor.
4. Confirm the “MONI” icon is displayed.

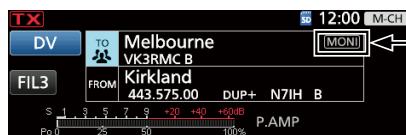

Displayed if the repeater can be monitored.

- ① The “MONI” icon is not displayed when:
 - The transceiver is not connected to the Internet.
 - The IP address list file is not selected.
 - The selected repeater’s call sign and IP address (or domain name) are not included in the IP address list file.

TIP: When using the Terminal mode, open the DV GATEWAY screen, and then touch “<<Terminal Mode>>.” (Section 12)

MENU » **DV GW**

- ① When using the External Gateway function, you cannot monitor the repeater.

Step 5. Turn ON the DV Repeater Monitor function (Transceiver)

1. Push **MULTI**.
2. Touch [RPT MONI] to turn ON this function.

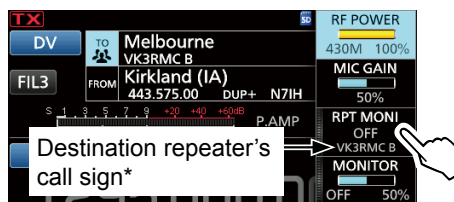

- * The call sign is not displayed when you select a repeater that cannot be monitored.
- Starts connecting to the destination repeater through the Internet.
- When using this function, the “MONI” icon displays the status.

Icon	Status
	The repeater can be monitored, but no connection
	Connected to the repeater
	Outputting the monitoring audio
	Muting the monitoring audio (For example, while receiving a signal from your access repeater that is selected in “FROM.”)

- ① Touching [RPT MONI] turns this function ON or OFF.
- ① This function is not turned OFF even if you change the destination repeater.
- ① The “MONI” icon may not change, depending on the repeater settings.

11. D-STAR OPERATION (ADVANCED)

BK mode communication

The Break-in (BK) function enables you to break into a conversation, where the 2 stations are communicating with the call sign squelch (DSQL) enabled.

- ① The BK function is automatically turned OFF when you turn OFF the transceiver.
- ① This function can be used in the DV or DD mode.

1. While 2 stations are communicating in the DV mode, touch **TONERX-CS** for 1 second.
 - After releasing **TONERX-CS**, the calling station's call sign or the repeater's call sign is set to "TO" (Destination).
 - Beeps sound and the calling station's call sign is announced.

① When a call sign is not received correctly, error beeps sound, and no call sign is set.

2. Open the BK screen.

MENU » **SET > DV/DD SET > BK**

3. Touch "ON."

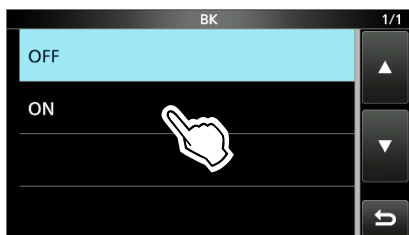

4. Push **EXIT** several times.

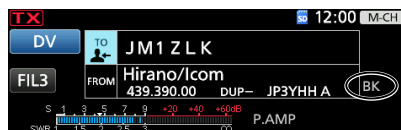

- Returns to the standby screen, and "BK" is displayed.

5. When both stations are in standby, push **TRANSMIT**, or hold down the microphone's [PTT] to transmit.

① "BK" blinks when receiving a Break-in call.

① To cancel the BK mode, select "OFF" in step 3, or turn OFF the transceiver.

How to use Break-in?

While using the Digital Call Sign squelch (DSQL), the squelch never opens (no audio is heard) even if a call is received, unless the call is addressed to your own call sign.

However, when a call including the "BK ON" signal (break-in call) is received, the squelch opens and audio is heard even if the call is addressed to another station.

Station C calling to Station A with "BK OFF"

Station A and B are communicating using the Digital Call Sign squelch.

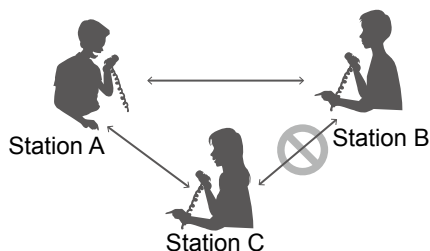

Station B does not hear that Station C is calling Station A.

Station C calling to Station A with "BK ON"

Station A and B are communicating using the Digital Call Sign squelch.

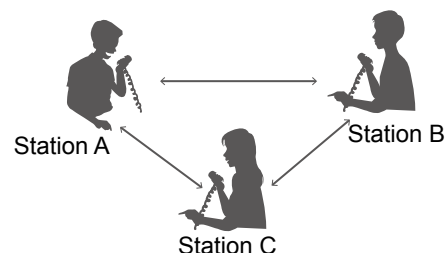

Station B also hears that Station C is calling Station A.

EMR communication

The Enhanced Monitor Request (EMR) communication function can be used in only the DV mode. Using the EMR function, no call sign setting is necessary.

① Information

- All transceivers that receive an EMR signal automatically open their squelch to receive the signal. DO NOT use this function except in the case of emergency.
- When an EMR signal is received, the audio (voice) is heard at the set level, even if the volume setting level is set to the minimum level.
- The EMR communication function is automatically turned OFF when you turn OFF the transceiver.

Example: Transmitting from the “Hirano” repeater using the EMR function.

1. Open the EMR screen.

MENU » **SET > DV/DD SET > EMR**

2. Touch “ON.”

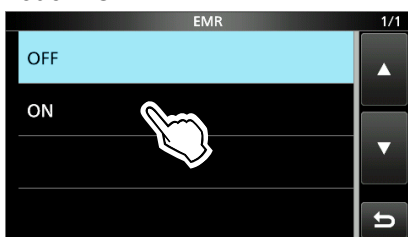

3. Push **MENU**.

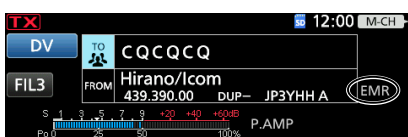

- Returns to the standby screen, and “EMR” is displayed.

4. Push **TRANSMIT**, or hold down the microphone’s [PTT] to transmit.

① “EMR” blinks on a station that receives the EMR signal. The audio (voice) is heard at the set EMR AF Level, or the **AF→RF/SQL** control level, whichever is higher.

① To cancel the EMR mode, select “OFF” in step 2, or turn OFF the transceiver.

◇ Adjusting the EMR AF level

The audio output level, when an EMR signal is received, is adjustable between 0 and 100%. When an EMR signal is received, the audio is heard at the preset level, or the **AF→RF/SQL** control level, whichever is higher.

To turn OFF the setting, set to “0.”

1. Open the EMR AF Level screen.

MENU » **SET > DV/DD SET > EMR AF Level**

2. Touch [+] or [-] to adjust the EMR audio output level between 0% (OFF) and 100% (maximum). (Default: 50%)

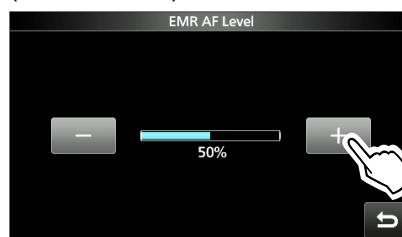

3. To close the EMR AF Level screen, push **EXIT**.

Automatic DV detection

If you receive an FM signal while in the DV mode, the “DV” and “FM” icons alternately blink to indicate the received signal is FM.

When the DV Auto Detect function is ON, the transceiver automatically selects the FM mode to temporarily monitor the signal. (Default: OFF)

① Regardless of this setting, the “DV” and “FM” icons alternately blink if you receive an FM signal while in the DV mode.

NOTE: When Digital Call Sign squelch (DSQL) or Digital Code squelch (CSQL) is selected, the transceiver does not receive FM signals, even if this function is ON. You can silently wait for calls from others.

1. Open the “DV Auto Detect” screen.
MENU » **SET > DV/DD SET > DV Auto Detect**

2. Touch “ON.”

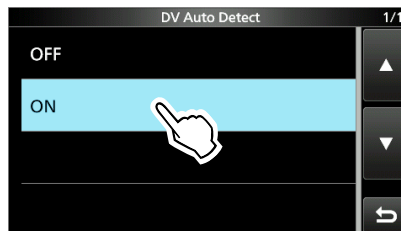

3. To close the DV/DD SET screen, push **EXIT**.
 ① When an FM signal is received while in the DV mode, the “DV” and “FM” icons sequentially blink, and the transceiver receives the signal in the FM mode.

When an FM signal is received while in the DV mode

DV Auto Detect function: OFF

The “DV” and “FM” icons alternately blink, but the audio cannot be heard.



The icons alternately blink. ▲ ▼

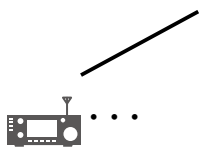

You cannot hear the audio.



DV Auto Detect function: ON

The “DV” and “FM” icons alternately blink, and the audio can be heard.



The icons alternately blink. ▲ ▼

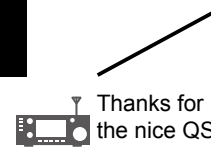

You can hear the audio!

11. D-STAR OPERATION (ADVANCED)

Automatic Reply function

When a call addressed to your own call sign is received, the Automatic Reply function sounds beeps and automatically replies with your call sign.

(Default: OFF)

Depending on the setting, a recorded message may be transmitted with the call sign.

1. Open the Auto Reply screen.

MENU » **SET > DV/DD SET > Auto Reply**

2. Touch an option.

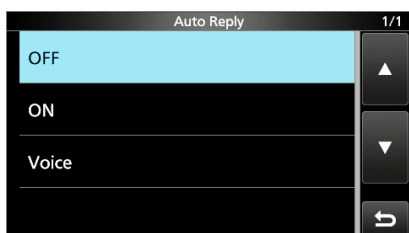

- ON: Automatically replies with your own call sign. (No audio reply is sent)
- Voice: Automatically replies with your call sign and an Auto Reply message recorded on the SD card (up to 10 seconds).
 - ① If no SD card is inserted, or no message is recorded, replies with your own call sign (No audio reply is sent).

3. To close the Auto Reply screen, push **EXIT**.



Auto Reply icon

- Returns to the standby screen, and displays the Auto Reply icon.
- ① When "ON" or "Voice" is selected, the Automatic Reply function is automatically turned OFF, when you transmit.

Example: After receiving a call from "JM1ZLK," beeps sound and the transceiver automatically sends a reply call.



The "TO" setting does not change, but "UR: JM1ZLK (Caller's call sign)" is displayed.

NOTE: The Automatic Reply function temporarily sets the received call sign to "TO" (destination).

TIP: To record the Auto Reply message

You can record the Auto Reply message. See page 11-23 for details.
(MENU > DV A-RPLY)

11. D-STAR OPERATION (ADVANCED)

Automatic Reply function

◇ Recording an Auto Reply message

You can record an Auto Reply message and save it on an SD card to reply to the call with your voice.



NOTE: Confirm an SD card is in the card slot.

1. Open the DV Auto Reply screen.

MENU » (2) > **DV A-RPLY**

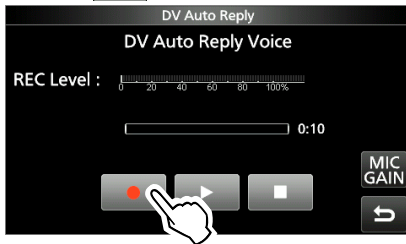
2. Touch “” to start recording.



- Touch “” to stop recording.
- Touch “” to playback the recorded message.

① Information

- The Maximum recording time is 10 seconds.
 - Hold the microphone 5 ~ 10 cm (2 ~ 4 inches) from your mouth, then speak at your normal voice level.
 - Touch [MIC GAIN] to open the MIC GAIN ADJUST screen.
 - Only 1 message can be recorded. The current contents is overwritten if you record again.
3. To close the DV Auto Reply screen, push **EXIT**.

The DV AUTO REPLY screen

Audio level is displayed Adjust the Mic gain so that the REC Level does not reach to this range.

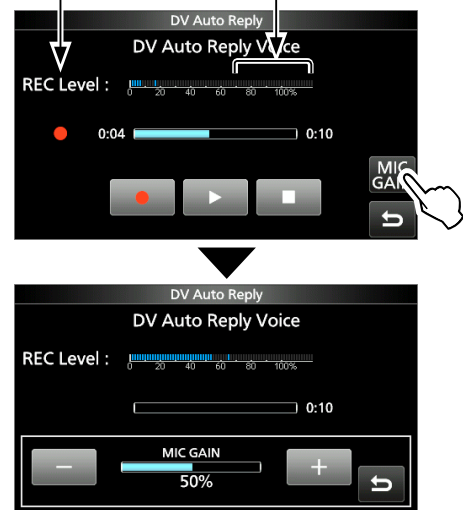

TIP: To delete the recorded message, push **QUICK** on the DV AUTO REPLY screen, then touch [Clear].

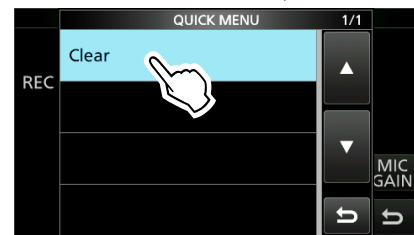

◇ When receiving a position data

When you transmitted a call to a station and the station automatically replies with the station's position data, the received position data is displayed in a window.

- ① Distance and direction are displayed only when the “GPS Select” item is set to “Manual.”
(**MENU** > **GPS** > **GPS Set** > **GPS Select**)
- ① You can turn OFF the caller's position display.
(**MENU** > **SET** > **Display** > **Reply Position Display**)

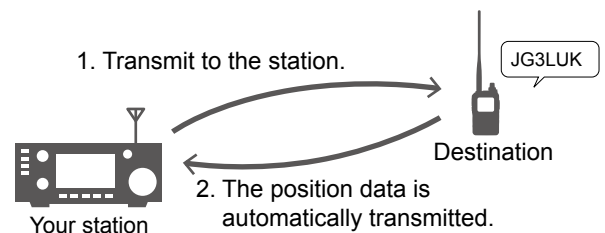

3. Received position data is displayed.



Scrolls received call sign or the TX message.

Data communication

In addition to digital voice communication, you can send and receive data. Also, you can use the DV Fast Data function for data communication. To send and receive data, the optional OPC-2350LU or a USB cable (user supplied), and a data communication software (user supplied) are required.

NOTE: DV Data TX is set to “Auto” as the default setting. When you enter text data into your communication software, the transceiver may automatically transmit it, depending on the software and the software settings.

◇ Connection

Connect the transceiver to your PC using the optional shown below.

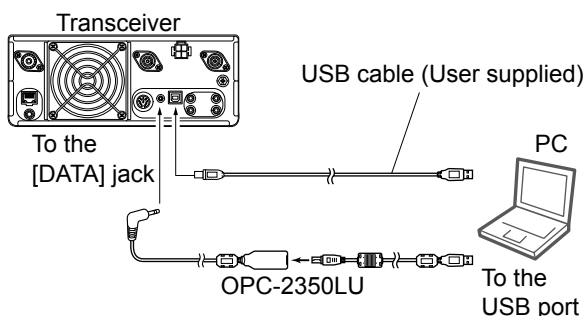

NOTE: Before you start sending data, BE SURE to set the following items.

- Set **GPS Select** to other than “External GPS.” (MENU > GPS > GPS Set > **GPS Select**)
- Set **GPS Out** to “OFF.” (MENU > SET > Connectors > USB (B)/DATA Function > **GPS Out**)

When using a USB cable (User supplied)

- Set **USB (B) Function** to “DV Data.” (MENU > SET > Connectors > USB (B)/DATA Function > **USB (B) Function**)

When using optional data communication cable

- Set **USB (B) Function** to “DV Data.” (MENU > SET > Connectors > USB (B)/DATA Function > **DATA Function**)

◇ Data communication application setting

Set the communication software, as shown below.

- Port: The COM port number that is used by the IC-9700.*1
- Baud rate: 4800/9600 bps*2
- Data: 8 bit
- Parity: none
- Stop: 1 bit
- Flow control: Xon/Xoff

*1 Depending on the PC environment, the COM port number used by the IC-9700 may be higher than 5. In that case, use an application that can set it to higher than 5.

*2 Set the baud rate in **Data Speed**.

(MENU > SET > Connectors > USB (B)/DATA Function > **DV Data/GPS Out Baud Rate**)

◇ Sending data

1. Set your own call sign, the destination call sign, and the repeater call sign.
2. Follow the instructions of your data communication application software.
3. When you enter text data into your communication software, the transceiver may automatically transmit it, depending on the software and the software settings.
 - ① When **DV Data TX** is set to “PTT,” pushing **TRANSMIT** or [PTT] on the microphone transmits the text data and a voice signal. (MENU > SET > DV/DD Set > **DV Data TX**)
 - ② Before transmitting, the transceiver sends approximately 500 milliseconds of carrier sense.

NOTE:

- Only ASCII code can be used for data communication.
- The transceiver has also a Message Transmission function that transmits up to 20 characters. (p. 11-15)
- Depending on the combination of your PC and your communication software, some data may be lost.
- While receiving voice or data through the Internet, some packets may be lost due to network error (poor data throughput performance). In such a case, an “L” is displayed on the screen to indicate that packet loss has occurred.

11. D-STAR OPERATION (ADVANCED)

Data communication

◇ DV Fast Data function

To send data using the DV Fast Data function, follow the instructions below.

The DV Fast Data communication can be made by only the following Icom transceivers: (As of May 2023)

- IC-705
- IC-905
- IC-9700
- ID-31A/E PLUS
- ID-4100A/E
- ID-5100A/E*
- ID-52A/E
- ID-51A/E (PLUS, PLUS2, 50th Anniversary model)

* Usable only when firmware versions CPU M 1.10, S 1.00, C 1.10, and DSP 1.10 or later are installed.

1. Open the DV FAST DATA screen.

MENU » **SET > DV/DD SET > DV Fast Data**

2. Touch "Fast Data."
3. Touch "ON."

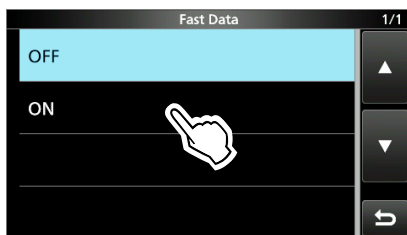

4. To close the DV Fast Data screen, push **EXIT**.

Digital squelch functions

The digital squelch opens only when you receive a signal addressed to your own call sign, or a signal that includes a matching digital code.

You can silently wait for calls from others.

You can independently set the Digital squelch function in the VFO mode, Memory mode, Call channel mode, or DR function.

◇ The Digital Call Sign squelch setting

1. Push **[FUNCTION]**.
2. Touch **[D.SQL]** several times to select "DSQL."
 - ① Each touch selects "DSQL," "CSQL" or "OFF."



3. Push **[EXIT]** to close the FUNCTION screen.



← "DSQL" is displayed.

- When the received signal includes a matching call sign, the squelch opens and you can hear the audio.
- ① When the received signal does not include a matching call sign, the digital call sign squelch does not open. However, the S/Rf meter displays the received signal level.

◇ The Digital Code Squelch setting

1. Push **[FUNCTION]**.
2. Touch **[D.SQL]** several times to select "CSQL."
 - ① Each touch selects "DSQL," "CSQL" or "OFF."



3. Touch **[D.SQL]** for 1 second.
4. Rotate **[MAIN DIAL]** to select a digital code.



← "CSQL" is displayed.

- Range: 00 ~ 99
- ① Touch **[DEF]** for 1 second to return the value to the default.

NOTE:

- **DO NOT** use the Digital Call Sign Squelch function when communicating with 2 or more stations, because the function opens only when receiving a signal addressed to your own call sign. Therefore the function can be used when communicating with only 1 station.
- Even if the squelch is closed by the Digital Call Sign Squelch function, you can receive data in the DV mode.

NOTE: Even if the squelch is closed by the Digital Code Squelch function, you can receive data in the DV mode.

Repeater list

You can save repeater information for quick and simple communication in up to 2500 repeaters (repeater list) on up to 50 Groups. Data must be in the repeater list to use the DR function. You can add and edit repeater content and groups in the repeater list.

You can enter 6 types of frequencies into the repeater list, as shown below:

- DV Repeater
- DV Simplex
- FM Repeater
- FM Simplex
- DD Repeater
- DD Simplex

◆ Repeater list contents

The following contents are included in the repeater list: See page 11-28 for details.

- TYPE: Communication type
- NAME: Repeater name
- SUB NAME: Repeater sub name
- CALL SIGN: Repeater call sign and port letter
- GW CALL SIGN: Gateway repeater's call sign and port "G"
- GW IP ADDRESS: Gateway IP address
- GROUP: Repeater group
- USE(FROM): Access repeater use
- FREQUENCY: Access repeater's frequency
- DUP: Duplex direction
- OFFSET FREQ: Frequency offset
- TONE: Tone setting
- REPEATER TONE: Repeater tone
- POSITION: Position data accuracy level
- LATITUDE: Latitude of the repeater
- LONGITUDE: Longitude of the repeater
- UTC OFFSET: UTC Offset

TIP:

- For easy operation, the repeater list is preloaded into your transceiver. However, if you do an All Reset, the CPU deletes all setting data, the Memory channels, and the repeater list. We recommend that you back up the memory data to an SD card or save it to a PC using the CS-9700 CLONING SOFTWARE.
- The repeater list can be downloaded from the Icom website.

<https://www.icomjapan.com/support/>

Example: "Hirano" repeater information

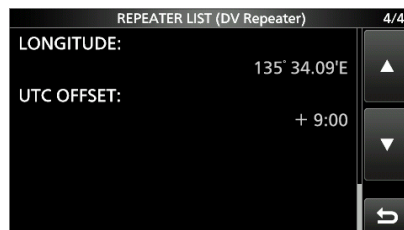
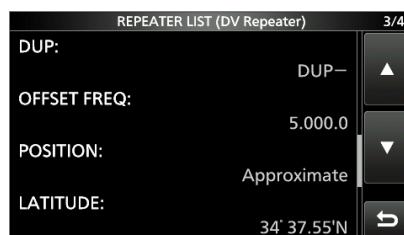
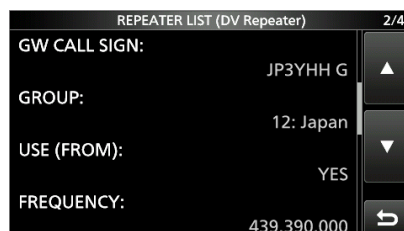

11. D-STAR OPERATION (ADVANCED)

Entering new information into the repeater list

This section describes how to manually enter new repeater information into the repeater list. The required setting items differ, depending on your communication usage. Confirm the required items, as shown below.

NOTE: To enter repeater information into the repeater list, the repeater's call sign must be entered first.

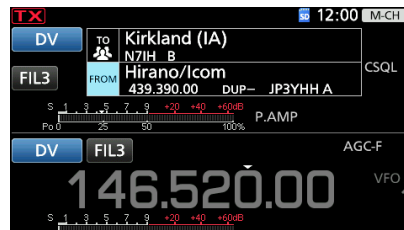

◇ Required items for the communication cases

Repeater list contents	Used as an access repeater		Used as a destination repeater		Used as an FM repeater	Simplex (FROM)		
	DV Repeater	DD Repeater	DV Repeater	DD Repeater	FM Repeater	DV Simplex	DD Simplex	FM Simplex
NAME	<input type="radio"/>	<input type="radio"/>	<input type="radio"/>	<input type="radio"/>	<input type="radio"/>	<input type="radio"/>	<input type="radio"/>	<input type="radio"/>
SUB NAME	<input type="radio"/>	<input type="radio"/>	<input type="radio"/>	<input type="radio"/>	<input type="radio"/>	<input type="radio"/>	<input type="radio"/>	<input type="radio"/>
CALL SIGN	<input checked="" type="radio"/>	<input checked="" type="radio"/>	<input checked="" type="radio"/>	<input checked="" type="radio"/>	<input type="radio"/>	N/A	N/A	N/A
GW CALL SIGN	<input checked="" type="radio"/> (For a Gateway call)	<input type="radio"/>	<input type="radio"/>	<input type="radio"/>	N/A	N/A	N/A	N/A
GW IP ADDRESS	N/A	<input checked="" type="radio"/>	N/A	<input checked="" type="radio"/>	N/A	N/A	N/A	N/A
GROUP	<input type="radio"/>	<input type="radio"/>	<input type="radio"/>	<input type="radio"/>	<input type="radio"/>	<input type="radio"/>	<input type="radio"/>	<input type="radio"/>
USE(FROM)	<input checked="" type="radio"/>	<input checked="" type="radio"/>	<input type="radio"/>	<input type="radio"/>	<input checked="" type="radio"/>	<input checked="" type="radio"/>	<input checked="" type="radio"/>	<input checked="" type="radio"/>
FREQUENCY	<input checked="" type="radio"/>	<input checked="" type="radio"/>	<input type="radio"/>	<input type="radio"/>	<input checked="" type="radio"/>	<input checked="" type="radio"/>	<input checked="" type="radio"/>	<input checked="" type="radio"/>
DUP	<input checked="" type="radio"/>	N/A	<input type="radio"/>	N/A	<input checked="" type="radio"/>	N/A	N/A	N/A
OFFSET FREQ	<input checked="" type="radio"/>	N/A	<input type="radio"/>	N/A	<input checked="" type="radio"/>	N/A	N/A	N/A
TONE	N/A	N/A	N/A	N/A	<input type="radio"/>	N/A	N/A	<input type="radio"/>
REPEATER TONE	N/A	N/A	N/A	N/A	<input type="radio"/>	N/A	N/A	<input type="radio"/>
POSITION	<input type="radio"/>	<input type="radio"/>	<input type="radio"/>	<input type="radio"/>	<input type="radio"/>	<input type="radio"/>	<input type="radio"/>	<input type="radio"/>
LATITUDE	<input type="radio"/>	<input type="radio"/>	<input type="radio"/>	<input type="radio"/>	<input type="radio"/>	<input type="radio"/>	<input type="radio"/>	<input type="radio"/>
LONGITUDE	<input type="radio"/>	<input type="radio"/>	<input type="radio"/>	<input type="radio"/>	<input type="radio"/>	<input type="radio"/>	<input type="radio"/>	<input type="radio"/>
UTC OFFSET	<input type="radio"/>	<input type="radio"/>	<input type="radio"/>	<input type="radio"/>	<input type="radio"/>	<input type="radio"/>	<input type="radio"/>	<input type="radio"/>

- : Must be entered
- : Possible to enter
- N/A: Not Applicable

11. D-STAR OPERATION (ADVANCED)

Entering new information into the repeater list

◇ Entering new information into the repeater list

Step 1. Selecting the repeater group

1. Open the DV/DD MEMORY screen.

MENU » (2) > **DV/DD MEMORY**



2. Touch "Repeater List."

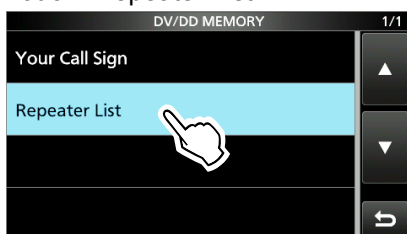

3. Touch a repeater group to add a repeater to.

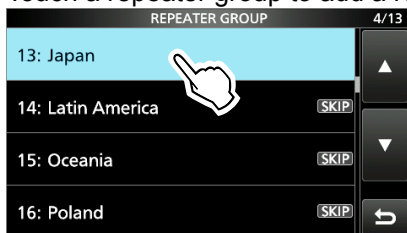

- Displays the repeater list of the selected repeater group.

4. Push **QUICK**.

5. Touch "Add."

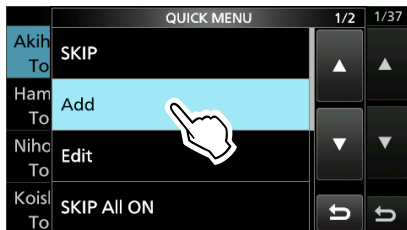

- The REPEATER LIST EDIT screen is displayed.

Step 2. Selecting the communication type

1. Touch "TYPE."
2. Touch the communication type.
 - DV Repeater: Repeater operation in the DV mode.
 - DV Simplex: Simplex operation in the DV mode.
 - FM Repeater: Repeater operation in the FM mode.
 - FM Simplex: Simplex operation in the FM mode.
 - DD Repeater: Repeater operation in the DD mode.
 - DD Simplex: Simplex operation in the DD mode.

Step 3. Entering the repeater name

1. Touch "NAME."
2. Enter a name of up to 16 characters.
3. After entering, touch [ENT].

Step 4. Entering the repeater sub name

1. Touch "SUB NAME."
2. Enter a sub name of up to 8 characters.
3. After entering, touch [ENT].

Step 5. Entering the repeater call sign

- ① When **Step 2. Selecting the communication type** is set to "DV Simplex," "FM Simplex" or "DD Simplex," go to **Step 8. Changing the repeater group**.

1. Touch "CALL SIGN."
2. Enter the repeater call sign of up to 8 characters, including spaces and the node letter.

NOTE: BE SURE to add the repeater node letter in the 8th digit of the call sign, according to the frequency band shown below. Note that there are almost always different node letters between Japanese D-STAR repeaters and repeaters in other countries.

Cross band operation between different nodes at the same repeater site can be made.

- 1200 MHz: A (B in Japan)
- 430 MHz: B (A in Japan)
- 144 MHz: C (no D-STAR repeaters in Japan)

3. After entering, touch [ENT].

► Continued on the next page

11. D-STAR OPERATION (ADVANCED)

Entering new information into the repeater list

◇ Entering new information into the repeater list

Step 6. Entering the gateway repeater call sign

- ① This item is displayed when **Step 2. Selecting the communication type** is set to “DV Repeater” or “DD Repeater.”
- ① The 8th digit in the call sign, entered in **Step 5. Entering the repeater call sign** is automatically set to “G” as the gateway port, so you can skip this setting and go to the next item.

1. Touch “GW CALL SIGN.”
2. Enter a gateway repeater call sign of up to 8 characters, including spaces.
 - ① Only a space or “G” can be entered in the 8th digit.
3. After entering, touch [ENT].

Step 7. Entering the Gateway IP address

- ① This item is displayed when **Step 2. Selecting the communication type** is set to “DD Repeater.”
1. Touch “GW IP ADDRESS.”
 2. Enter the IP address.
 - Range: 0.0.0.1 ~ 255.255.255.254
 3. After entering, touch [ENT].

Step 8. Changing the repeater group

1. Touch “GROUP.”
2. Touch the repeater group. (01 ~ 50)

Step 9. Setting “USE(FROM)” to be used as an Access repeater

- ① You can use the entered repeaters as an access repeater when using the DR function. When not using as an access repeater, select “NO,” and go to **Step 15. Selecting the position data accuracy level**. In that case, the entered repeater is not displayed in “FROM” on the DR screen.

1. Touch “USE(FROM).”
2. Touch “YES” to use the repeater as an access repeater.

Step 10. Entering the access repeater frequency

1. Touch “FREQUENCY.”
2. Enter the repeater frequency.
3. After entering, touch [ENT].

Step 11. Selecting the Duplex direction

- ① This item is displayed when **Step 2. Selecting the communication type** is set to “DV Repeater” or “FM Repeater.”
- ① “DUP-” is automatically set when the access repeater frequency is entered in **Step 10. Entering the access repeater frequency**. If necessary, you can change the Duplex direction.

1. Touch “DUP.”
2. Touch a Duplex direction.
 - OFF: Turn the duplex function OFF.
 - DUP-: The transmit frequency shifts down from the receive frequency by the offset amount.
 - DUP+: The transmit frequency shifts up from the receive frequency by the offset amount.

Step 12. Entering the frequency offset

- ① This item is displayed when **Step 2. Selecting the communication type** is set to “DV Repeater” or “FM Repeater.”
- ① The offset value* is automatically set when the access repeater frequency is entered in **Step 10. Entering the access repeater frequency**. If necessary, you can change the frequency offset.
- * The default value differs, depending on the transceiver version.

1. Touch “OFFSET FREQ.”
2. Enter the frequency offset.
 - Range: 0.000.00 ~ 99.999.9 MHz
3. After entering, touch [ENT].

Step 13. Setting the tone

- ① This item is displayed when **Step 2. Selecting the communication type** is set to “FM Repeater” or “FM Simplex.”
1. Touch “TONE.”
 2. Touch an option.
 - OFF: Turn OFF the Tone function.
 - TONE: Select when the repeater requires an access tone.
 - TSQL: Select when you want to use the tone squelch operation in simplex.

► Continued on the next page

11. D-STAR OPERATION (ADVANCED)

Entering new information into the repeater list

◇ Entering new information into the repeater list

Step 14. Selecting the repeater tone frequency

- ① This item is displayed when **Step 2. Selecting the communication type** is set to "FM Repeater" or "FM Simplex."
- ① This setting is required when **Step 13. Setting the tone** is set to "TONE" or "TSQL."

1. Touch "REPEATER TONE."
2. Set the repeater tone frequency.
3. Push **EXIT**.

Step 15. Selecting the position data accuracy level

- ① When the Near Repeater Search function is not used, or the distance between your position and a repeater is not needed, select "None," and go to **Step 18. Setting the UTC offset**.

1. Touch "POSITION."
2. Touch the position data accuracy level.
 - None: Select when the repeater has no position data.
 - Approximate: Select when the entered position data is approximately correct.
 - Exact: Select when the entered position data is exactly correct.

Step 16. Entering the latitude

- ① This item is displayed only when **Step 15. Selecting the position data accuracy level** is set to "Approximate" or "Exact."

1. Touch "LATITUDE."
2. Enter the latitude.
 - ① To enter a north latitude, select "N," and to enter a south latitude, select "S."
3. After entering, touch [ENT].

Step 17. Entering the longitude

- ① This item is displayed only when **Step 15. Selecting the position data accuracy level** is set to "Approximate" or "Exact."

1. Touch "LONGITUDE."
2. Enter the longitude.
 - ① To enter an east longitude, select "E," and to enter a west longitude, select "W."
3. After entering, touch [ENT].

Step 18. Setting the UTC offset

- ① Universal Time Coordinated (UTC) offset is the time difference between UTC and repeater local time. This is a useful function to know the local time of the destination repeater before you make a call.

1. Touch "UTC OFFSET."
2. Set the time difference between UTC and the local time.
3. Push **EXIT**.

Step 19. Saving the repeater list

1. Touch "<<Add Write>>".
 - The confirmation dialog is displayed.
2. Touch <YES>.
 - The entered contents are saved in the repeater list, and the display returns to the selected repeater group screen.

TIP: To cancel the entered data

1. Push **EXIT** to display the "Cancel edit?" window.
2. Touch <YES>.

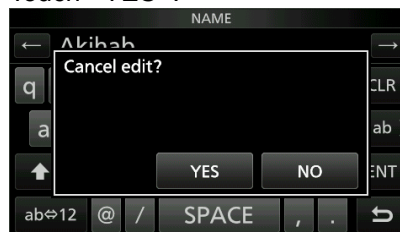

- Cancels entry and returns to the selected repeater group screen.

11. D-STAR OPERATION (ADVANCED)

Entering new information into the repeater list

◇ Editing repeater data

You can edit repeater data. This is useful when already-entered data is incorrect, has changed, or some data needs to be added to the list.

1. Open the REPEATER GROUP screen.

MENU » (2) > DV/DD Memory > **Repeater List**

2. Touch a repeater group where the repeater you want to edit is listed.



3. Touch a repeater you want to edit for 1 second.



4. Touch "Edit."

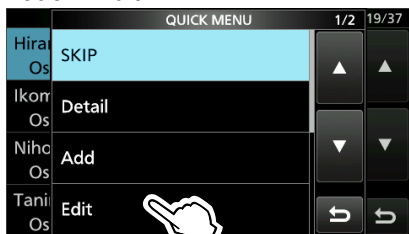

5. Touch an item, then edit it.
① See pages 11-29 ~ 11-31 for details.
6. After editing, touch "<<Overwrite>>."

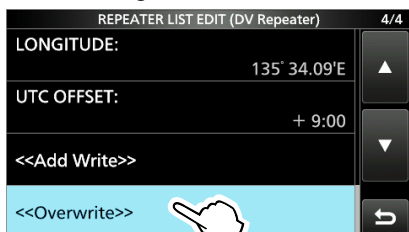

- The confirmation dialog is displayed.

7. Touch <YES>.

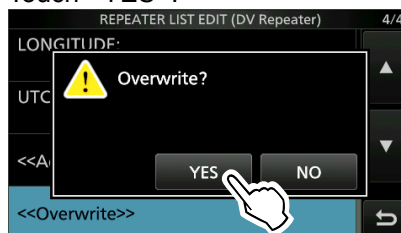

- The edited contents are saved into the repeater list, and returns to the selected repeater group screen.

8. Push **EXIT** several times to close the Repeater List screen.

11. D-STAR OPERATION (ADVANCED)

Entering new information into the repeater list

◇ Deleting repeater data

1. Open the REPEATER GROUP screen.
MENU » **(2)** > DV/DD Memory > **Repeater List**
2. Touch a repeater group where the repeater you want to delete is listed.



3. Touch the repeater to be deleted for 1 second.



4. Touch "Delete."

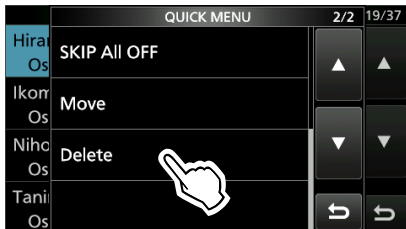

- The confirmation dialog is displayed.

5. Touch <YES>.

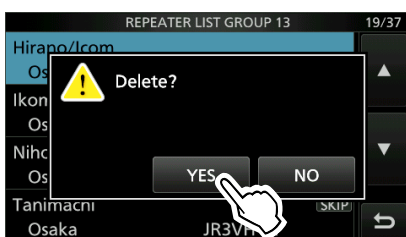

- The selected repeater contents are deleted from the repeater list, and returns to the selected repeater group screen.

6. Push **EXIT** several times to close the Repeater List screen.

NOTE: The currently selected repeater on the DR screen cannot be edited or deleted. To edit or delete the repeater, select another repeater on the DR screen.



11. D-STAR OPERATION (ADVANCED)

Entering new information into the repeater list

◇Rearranging the display order of the repeaters

You can move the entered repeaters to rearrange their display order in the selected repeater group.

Example: Moving “Hirano/Icom” above “Nakano.”

1. Open the REPEATER GROUP screen.
MENU » **(2) > DV/DD Memory > Repeater List**

2. Touch a repeater group where the repeater you want to move is listed.

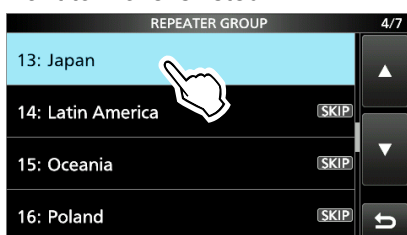

3. Touch the repeater to be moved for 1 second.



4. Touch “Move.”

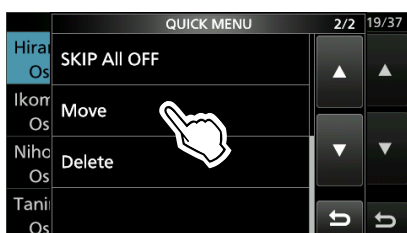

5. Touch a repeater to insert the repeater you want to move above it.

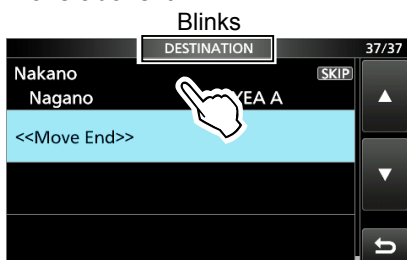

- The selected repeater is inserted above the destination repeater name.
- ① If “<<Move End>>” is selected, the repeater is moved to the bottom of the group.

6. Push **EXIT** several times to close the Repeater List screen.

◇Adding a new repeater information from RX History

1. Open the RX HISTORY screen.
MENU » **(2) > CD**
2. Rotate **MAIN DIAL** to display the repeater you want to add to the repeater list.

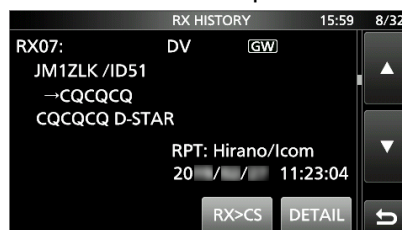

3. Touch [DETAIL].
4. Rotate **MAIN DIAL** to display “RXRPT1” and “RXRPT2.”

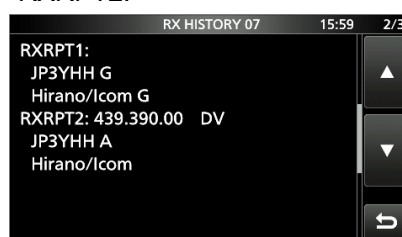

5. Push **QUICK**.
6. Touch “Add To Repeater List.”

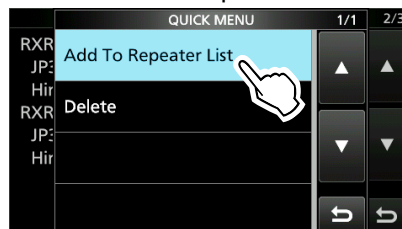

7. Touch the repeater call sign that you want to add to the repeater list.

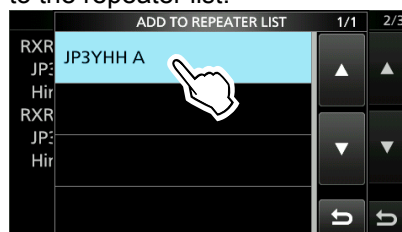

- Displays the REPEATER LIST EDIT screen. The selected repeater call sign is automatically entered.
 - ① See pages 11-29 ~ 11-31 to edit the contents.
8. Touch “<<Add Write>>.”
 - The confirmation dialog is displayed.
 9. Touch <YES>.
 - The repeater contents are added to the repeater list, and the display returns to the RX HISTORY screen.

11. D-STAR OPERATION (ADVANCED)

Entering new information into the repeater list

◇ Skip setting for the DR scan

You can set repeaters as scan skip repeaters. The selected repeaters are skipped for faster scanning. You can set the skip setting to all repeaters in the selected repeater group, or to individual repeaters.

- ① When a repeater is set as a skip repeater, its “USE (FROM)” setting is automatically set to “NO.” In that case, the repeater cannot be selected in “FROM” (Access repeater) on the DR screen.

<Individual skip setting>

- Open the REPEATER GROUP screen.
MENU » (2) > DV/DD Memory > **Repeater List**
- Select a repeater group where the repeater you set the skip setting is listed.

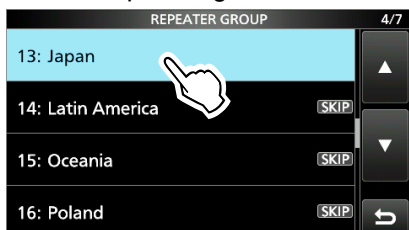

- Touch the repeater to be skipped for 1 second.



- Touch “SKIP.”

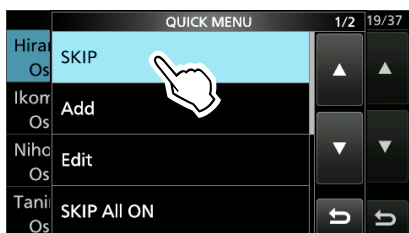

- Displays “SKIP” in the upper right corner.
- ① Select “SKIP” again to cancel the skip setting.
- ① Select “SKIP All ON” to set the skip setting to all repeaters in the group.

- Push **EXIT** several times to close the Repeater List screen.

<Group skip setting>

On the REPEATER GROUP screen, push **QUICK**, then select “SKIP All ON” to skip the repeaters in the group during the DR scan.

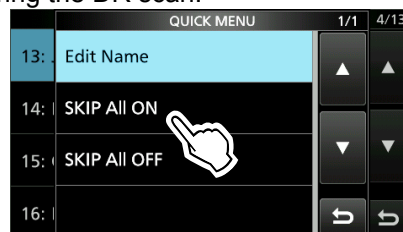

- ① To cancel the skip settings in the group, select “SKIP All OFF.”

TIP:

- When you select “Repeater List” on the FROM SELECT screen, you can set the skip setting as described to the left.

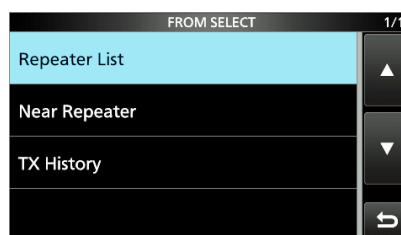

- When “FROM” is selected on the DR screen, push **QUICK** to set the skip setting, as shown below. Rotate **MAIN DIAL** to select SKIP, then touch it.

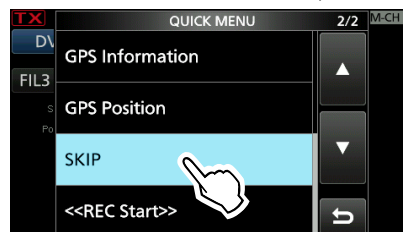

- ① Displays “SKIP” in the “FROM” field.

11. D-STAR OPERATION (ADVANCED)

Entering new information into the repeater list

◇ Entering or editing a repeater group name

1. Open the REPEATER GROUP screen.
MENU » (2) > DV/DD Memory > **Repeater List**
2. Touch a Repeater group that you edit the name for 1 second.

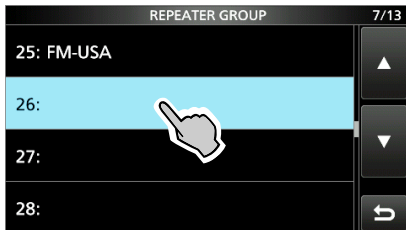

3. Touch "Edit Name."

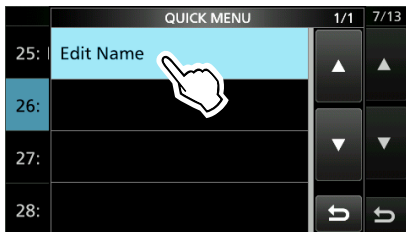

4. Enter a group name of up to 16 characters, and then touch [ENT].

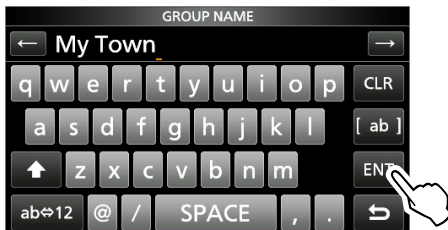

Selectable characters and symbols

A to Z, a to z, 0 to 9, ! " # \$ % & ' () * +
, - . / : ; < = > ? @ [\] ^ _ ` { | } ~ (space)

5. Push **EXIT** several times to close the Repeater Group screen.

Your Call Sign

◇ Entering Your Call Sign

You can manually enter a Your (destination) Call Sign. When a Your Call Sign is set to "TO," you can make a call to the station, even if you do not know where the station is currently located. Up to 300 "Your Call Signs" can be entered.

Example: Entering "Tom/JG3LUK" to the Your Call Sign memory.

1. Open the YOUR CALL SIGN screen.
MENU » **DV/DD Memory > Your Call Sign**

2. Push **QUICK**.
3. Touch "Add."

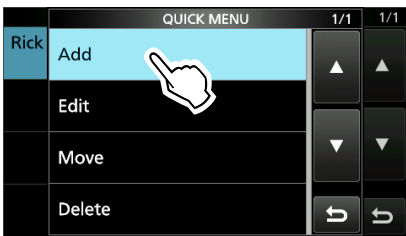

4. Touch "NAME."

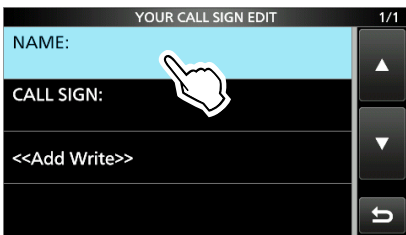

5. Enter a station name of up to 16 characters, and then touch [ENT].

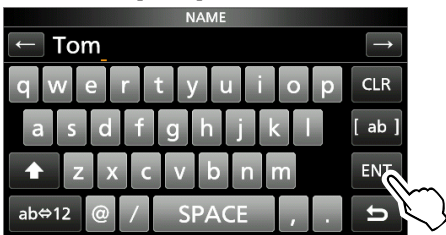

Selectable characters and symbols
 A to Z, a to z, 0 to 9, ! " # \$ % & ' () * + , - . / : ; < = > ? @ [\] ^ _ ` { | } ~ (space)

6. Touch "CALL SIGN."

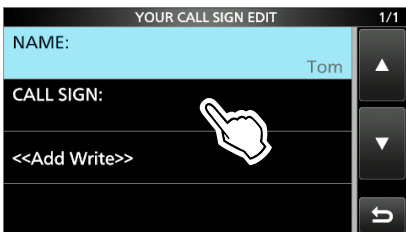

7. Enter Your call sign of up to 8 characters, including spaces, and then touch [ENT].

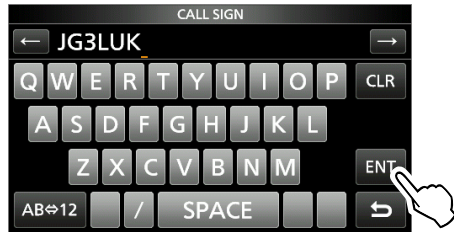

8. Touch "<<Add Write>>."

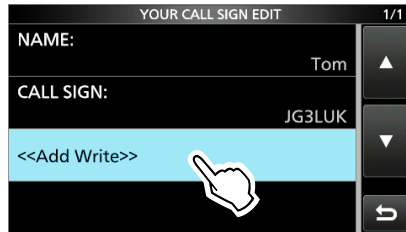

• The confirmation dialog is displayed.

9. Touch <YES>.

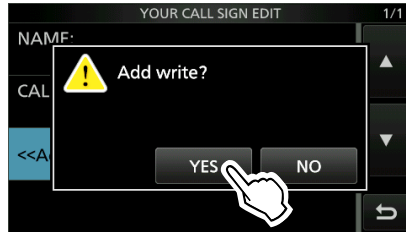

10. Push **EXIT** several times to close the YOUR CALL SIGN screen.

TIP:
To cancel the entered call sign
 Push **EXIT** to display the "Cancel edit?" window. Touch "YES" to cancel the entry and return to the YOUR CALL SIGN screen.



To edit the entered call sign
 To edit the entered call sign, select "Edit" in step 3.

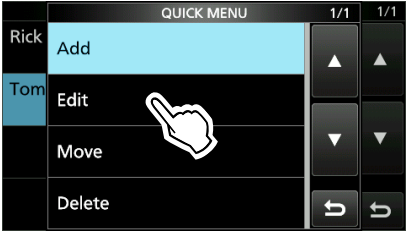

11. D-STAR OPERATION (ADVANCED)

Your Call Sign

◇ Deleting Your Call Sign

1. Open the YOUR CALL SIGN screen.
MENU » **DV/DD Memory > Your Call Sign**
2. Touch a call sign you want to delete for 1 second.

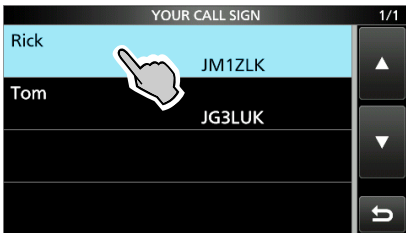

3. Touch "Delete."

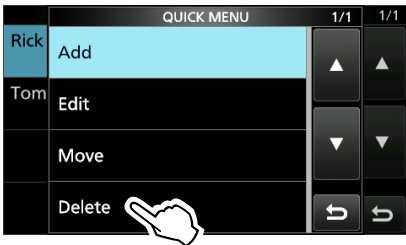

- A confirmation dialog is displayed.

4. Touch <YES>.

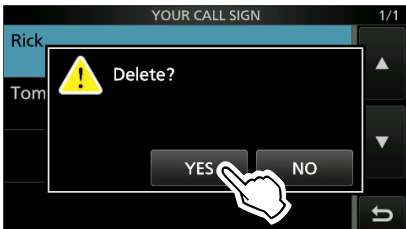

- The selected call sign is deleted from the Your Call Sign list, and the returns to the YOUR CALL SIGN screen.

5. Push **EXIT** several times to close the YOUR CALL SIGN screen.

NOTE: The currently selected Your Call Sign on the DR screen cannot be edited or deleted. To edit or delete the Your Call Sign, select another Your Call Sign on the DR screen.

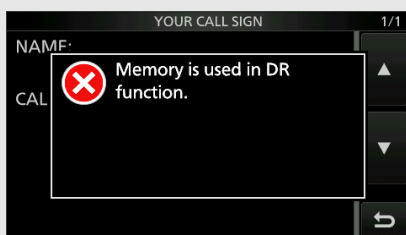

◇ Rearranging the display order of Your Call Signs

You can move Your Call Signs to rearrange their display order.

If the stations you often communicate with are moved to the top of the list, it is easy to find them.

Example: Moving "Rick" above "Eddy."

1. Open the YOUR CALL SIGN screen.
MENU » **DV/DD Memory > Your Call Sign**
2. Touch a Your Call Sign to be moved for 1 second.

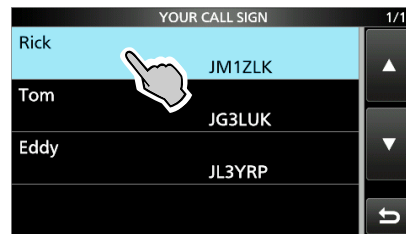

3. Touch "Move."

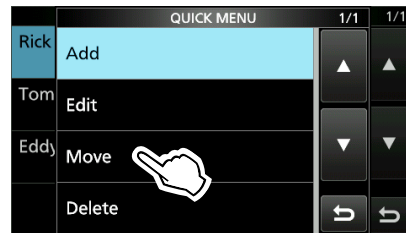

4. Touch the position to insert the Your Call Sign you want to move the call sign above.



- While moving, "DESTINATION" blinks.
- The selected call sign is inserted above the destination call sign.

① If "<<Move End>>" is selected, the Your Call Sign is moved to the bottom of the group.

5. Push **EXIT** several times to close the YOUR CALL SIGN screen.

Manually setting Call Signs

Set or view the “UR,” “R1,” “R2,” and “MY” call signs to use in the DV mode.

MENU » (2) > **CS**

When not using the DR function, sets the call signs on this screen.

For Simplex operation (DV mode/DD mode)

You can set the “UR” and “MY” call signs.

For Duplex (repeater) operation (DV mode/DD mode/DR function)

You can set only the “MY” call sign when the DR function is ON.

<To manually set the Duplex (repeater) operation>

Example: Making a gateway CQ call to Kirkland repeater (N71H B) from the Hirano repeater (JP3YHH A), in the DV mode.

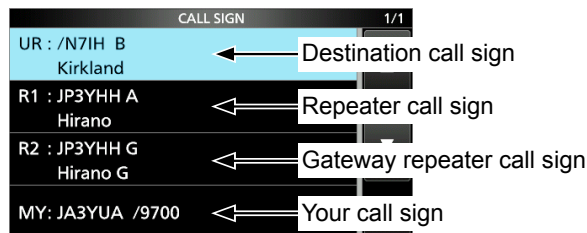

① Before starting to set the call sign, set the frequency of your Access repeater and duplex direction on the standby screen.

TIP: When the Digital Repeater Set function is ON, the repeater call sign is automatically set.

MENU » SET > DV/DD Set > **Digital Repeater Set**

Step 1. Setting the call sign “R1”

1. Touch “R1” for 1 second.
2. Touch “Edit.”
3. Enter the repeater call sign of up to 8 characters, including spaces. (Example: JP3YHH A)
4. Touch [ENT].
 - Sets the entered repeater call sign.

Step 2. Gateway “R2” setting

1. Touch “R2.”
 - ① To manually enter a call sign, touch “R2” for 1 second, then touch “Edit.”
2. Touch “GW.”

About the RPT2 SELECT screen

NOT USED*	For local area calls
GW	To select the gateway call sign from the repeater list.
Repeater name	To select the repeater that has the same gateway as the “R1” repeater.

Step 3. Destination “UR” setting

1. Touch “UR.”
 - ① To manually enter a call sign, touch “UR” for 1 second, then touch “Edit.”
2. Touch “Gateway CQ.”
3. Touch repeater group where your destination repeater is listed.
4. Touch a destination repeater.

About the YOUR SELECT screen

CQCQCQ	To select “CQCQCQ” to make a non-call sign specific call.
Gateway CQ*	To select “Gateway CQ” to make a call using the repeater list.
Your Call Sign	To select the destination “UR” call sign using the Your Call Sign memory.
RX History	To select the destination “UR” call sign using RX History.
TX History	To select the destination “UR” call sign using TX History.

* Not displayed in the Simplex mode.

11. D-STAR OPERATION (ADVANCED)

Are your settings correct?

If you make a Local Area call with a gateway setting still selected in "TO," the destination repeater will be busy while you transmit.

The stations that want to use the repeater as their Access repeater cannot access it, as shown below.

BE SURE to set CQCQCQ in "TO" on the DR screen when you intend to make a Local Area call, or after you finish a Gateway call.

Example: JG3LUK wants to make a Local Area call.

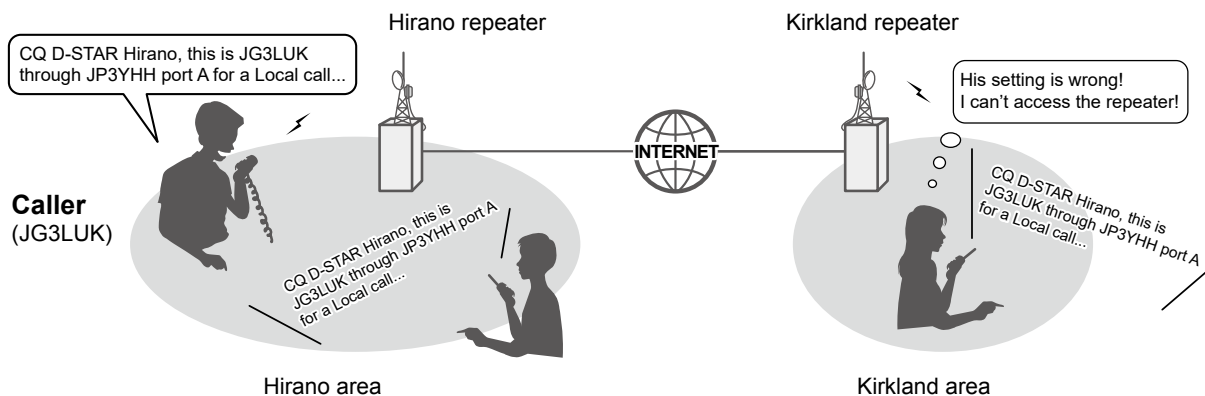

JG3LUK's setting

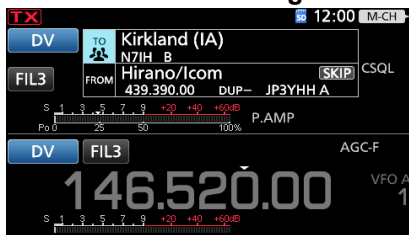

The destination ("TO") setting is incorrect.

NOTE: With this setting, you can make a Local Area call, but the destination Repeater, selected in "TO," is also busy while you transmit. The stations that want to use the repeater as their Access Repeater cannot access it.

Correct setting



To make a Local Area call, set the destination ("TO") to "CQCQCQ." See page 11-8 for details.

Using the RS-MS1A

The RS-MS1A is a freeware application for Android devices.

With the RS-MS1A, you can use the extended D-STAR functions to exchange image files or text messages, or display the received D-PRS station data on a map program.

To use the RS-MS1A, download it from the Google Play store of your Android device.

NOTE:

- Before starting, be sure to set the following items.

MENU » **SET > Connectors > CI-V**

- Set "CI-V Transceive" to "ON."
- Set "CI-V DATA Baud Rate" to the same baud rate as the RS-MS1A.
- Set "CI-V DATA Echo Back" to "OFF."

MENU » **SET > Connectors > USB (B)/DATA Function**

- Set "USB (B) Function" to "OFF."
- Set "DATA Function" to "CI-V."
- Set "GPS Out" to "OFF."

- You cannot use the RS-MS1A while in the Access Point mode.

◆ Required items

The following system is required to use the RS-MS1A.
(As of May 2023)

- **Android device**
Android 5.0 or later with the USB host function.
① The RS-MS1A has been tested with the Android 5.x.x, 6.x.x, 7.0, 8.0, 9, and 10.
- **Cable** (purchase separately)
OPC-2350LU DATA CABLE
① If your Android device has a USB Type-C port, you need a USB On-The-Go (OTG) adapter to convert the data cable's plug to USB Type-C.

NOTE: Some function may not work correctly,
• depending on other applications installed in the Android device.
• depending on the memory capacity.

TIP: The USB host function is needed to use a USB device with an Android device. To check whether or not your Android device has the USB host system, ask the Android device's manufacturer.

- ① For operations or settings of the Android device, read the Android device's instruction manual.
- ① Display indications may differ depending on the OS version or settings.

◆ Installing the application

1. Start the Android device.
2. Touch "Play store."
3. Enter "RS-MS1A."
① **DO NOT** abbreviate the application name to be sure to find it.
4. Touch "🔍 (search)."
• The RS-MS1A application information is displayed.
① If your Android device is not compatible with the RS-MS1A, the application is not displayed.
5. Touch "RS-MS1A."
6. Touch "Install."
7. Touch "Agree to download."
• Starts installing the application.
• After the installation is completed, the icon is displayed on your home screen.

◆ Connecting the OPC-2350LU

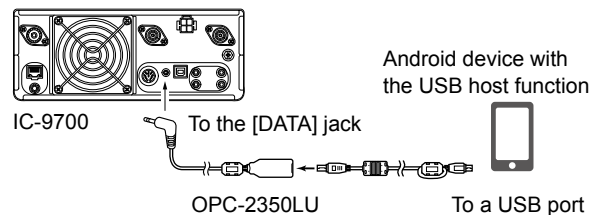

NOTE:

- Turn OFF the transceiver before connecting or removing the cable.
- Remove the cable when you do not use the cable. Otherwise, the battery will be quickly exhausted.

Section 12 ABOUT THE DV GATEWAY FUNCTION

About the DV Gateway function	12-2
When using the External Gateway function.....	12-2
About the Terminal/AP Call sign	12-3
◇ When operating in the Terminal mode.....	12-3
◇ When operating in the AP mode.....	12-3
Setting up a network.....	12-4
◇ When connecting your device to the Internet using a router	12-6
◇ When connecting your device to the Internet using a cellular system.....	12-8
◇ When connecting your device to the Internet using a mobile router	12-9
Setting up the device	12-10
◇ When using the Internal Gateway function.....	12-10
◇ When using the RS-MS3W software.....	12-12
◇ When using the RS-MS3A.....	12-13
Terminal mode operation	12-14
◇ Setting the Terminal mode.....	12-14
◇ Operating in the Terminal mode	12-15
Access Point mode operation.....	12-16
◇ Setting the Access Point mode.....	12-16
◇ Making a Gateway call through the Access point transceiver	12-17
Troubleshooting	12-21
◇ Error icon of the transceiver	12-21
◇ Troubleshooting for the Terminal mode operation	12-22
◇ Troubleshooting for the Access Point mode operation	12-24
◇ Error messages of the RS-MS3W and the RS-MS3A	12-26

About the DV Gateway function

Even if you cannot access a D-STAR repeater, you can make Gateway calls with the DV Gateway function. There are two modes, the Terminal mode and the Access Point mode.

- ① Other stations can also directly communicate using the DV Gateway function, only if they use call sign routing.
- ② When using the DV Gateway function, you cannot make a Local area call.

IMPORTANT:

- Before operating in the Terminal mode or the Access Point mode, **BE SURE** to check your local regulations or laws.
- Register your call sign (MY) at a gateway server.*
- Register the Terminal/AP call sign that is set in the transceiver, RS-MS3A, or RS-MS3W to the RS-RP3C as the access point.*

* Ask the gateway repeater administrator for details.

Terminal mode

The Terminal mode enables you to make Gateway calls through the Internet. In the Terminal mode, the transceiver does not transmit or receive RF signals through the antenna.

When using the Internal Gateway function:

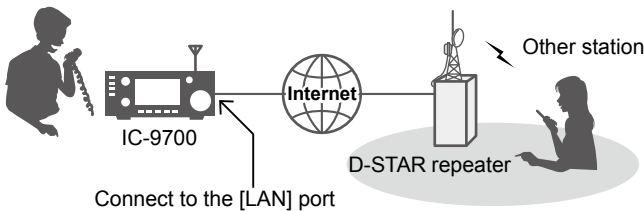

Access Point mode

The Access Point mode enables you to use another D-STAR transceiver and remotely*¹ make Gateway calls through an Access point transceiver.

When using the Internal Gateway function:

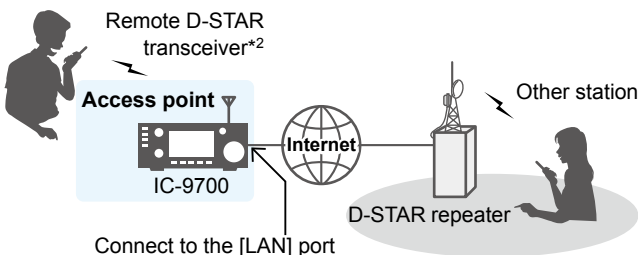

*¹ Within the transmit and receive range of the Access point transceiver. The range will vary, depending on the operating environment.

*² Any model as long as the transceiver is D-STAR capable. Only one D-STAR transceiver can access the Access Point at the same time.

NOTE: When using the DV Gateway function

- When operating in the Access Point mode, you need two call signs. One for the Access Point transceiver and one for the Remote D-STAR transceiver. (p. 12-3)
- You need an Internet connection with an IPv4 Global IP address. If you use a cellular system, you need an IPv4 Global IP address assigned to your Windows or Android device.
- When you use your Windows or Android device, read the RS-MS3W or RS-MS3A instruction manual in addition to this document. They can be downloaded from the Icom website. (pp. 12-12, 12-13)

When using the External Gateway function

Even if you cannot connect the transceiver to the Internet directly, or you want to use a cellular system, you can use the DV Gateway function by using a Windows or Android device that is running the RS-MS3W or RS-MS3A application.

- ① You need the OPC-2350LU to connect the transceiver to your device.

Terminal mode

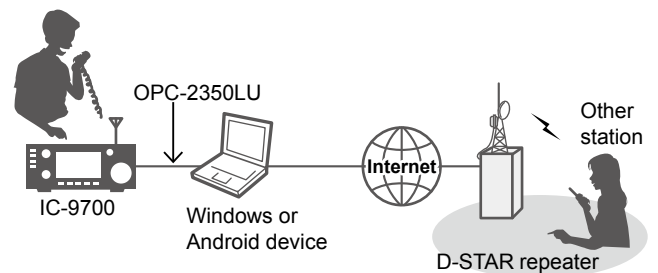

Access Point mode

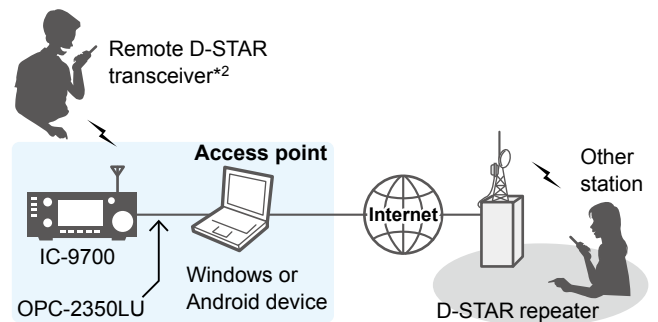

Set "Gateway Select" to "External Gateway"

1. Open the Gateway Select screen.
MENU » (2) > DV GW > **Gateway Select**
2. Touch "External Gateway (DATA)."

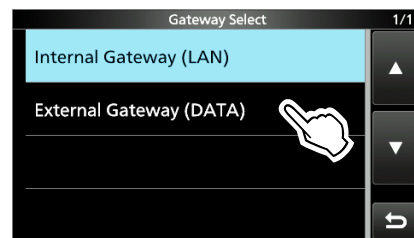

About the Terminal/AP Call sign

◇ When operating in the Terminal mode

IMPORTANT:

- Register your call sign (MY) at a gateway server.*
- Register the Terminal/AP call sign that is set in the transceiver, RS-MS3A, or RS-MS3W software application to the RS-RP3C repeater gateway software as the access point.*

* Ask the gateway repeater administrator for details.

① **Information**

- The Terminal Call sign should be 8 characters. Enter spaces between MY call sign and the 8th character.
- Enter a unique ID suffix between A and F at the end of MY Call Sign for the 8th character.
- Call signs shown below are just examples.

When using the Internal Gateway function

Enter the Terminal Call sign in "Terminal/AP Call sign" in the transceiver. (p. 12-10)

MENU » (2) > DV GW > Internal Gateway Settings > **Terminal/AP Call sign**

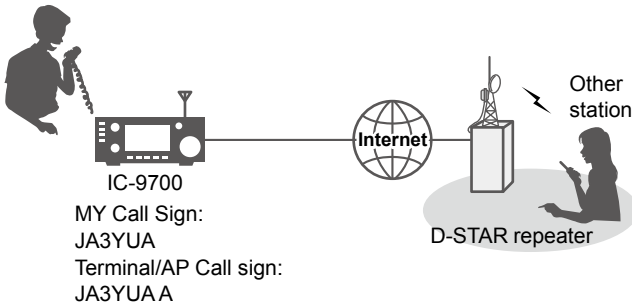

When using the External Gateway function

Enter the Terminal Call sign in "Terminal/AP Call sign" in the RS-MS3W or RS-MS3A.

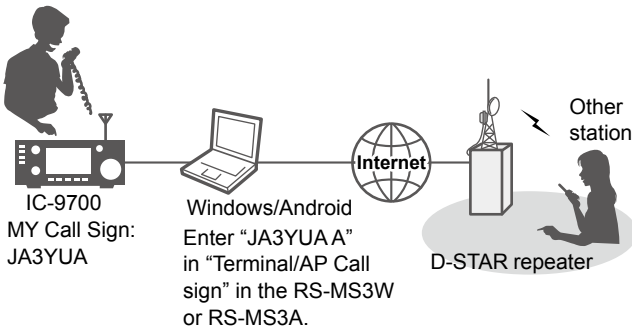

◇ When operating in the AP mode

IMPORTANT:

- Register your call sign (MY) at a gateway server.*
- Register the Terminal/AP call sign that is set in the transceiver, RS-MS3A, or RS-MS3W software application to the RS-RP3C repeater gateway software as the access point.*

* Ask the gateway repeater administrator for details.

① **Information**

- The AP Call sign should be 8 characters. Enter spaces between Access Point (AP) transceiver's MY call sign and the 8th character.
- Enter a unique ID suffix between A and F at the end of MY Call Sign for the 8th character.
- Call signs shown below are just examples.

When using the Internal Gateway function

Enter the AP Call sign in "Terminal/AP Call sign" in the transceiver. (p. 12-10)

MENU » (2) > DV GW > Internal Gateway Settings > **Terminal/AP Call sign**

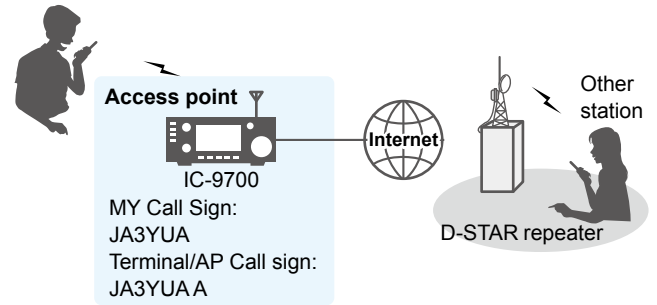

When using the External Gateway function

Enter the AP Call sign in "Terminal/AP Call sign" in the RS-MS3W or RS-MS3A.

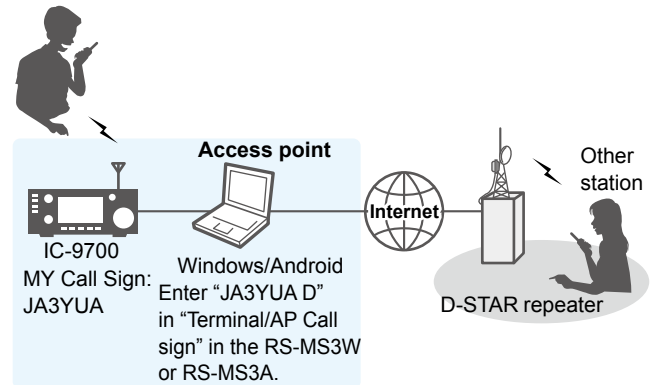

Setting up a network

Before using the DV Gateway function, you have to set up a network.

When using the Internal Gateway function

See page 12-6.

When using the External Gateway function

1. When connecting your device*1 to the Internet using a router (p. 12-6)
2. When connecting your device*1 to the Internet using a cellular system (p. 12-8)
3. When connecting your device*1 to the Internet using a mobile router (p. 12-9)

*1 Windows or Android device

NOTE: Depending on your contract, you may be charged a large or additional communication fee. Ask your Internet service provider about the content of your contract.

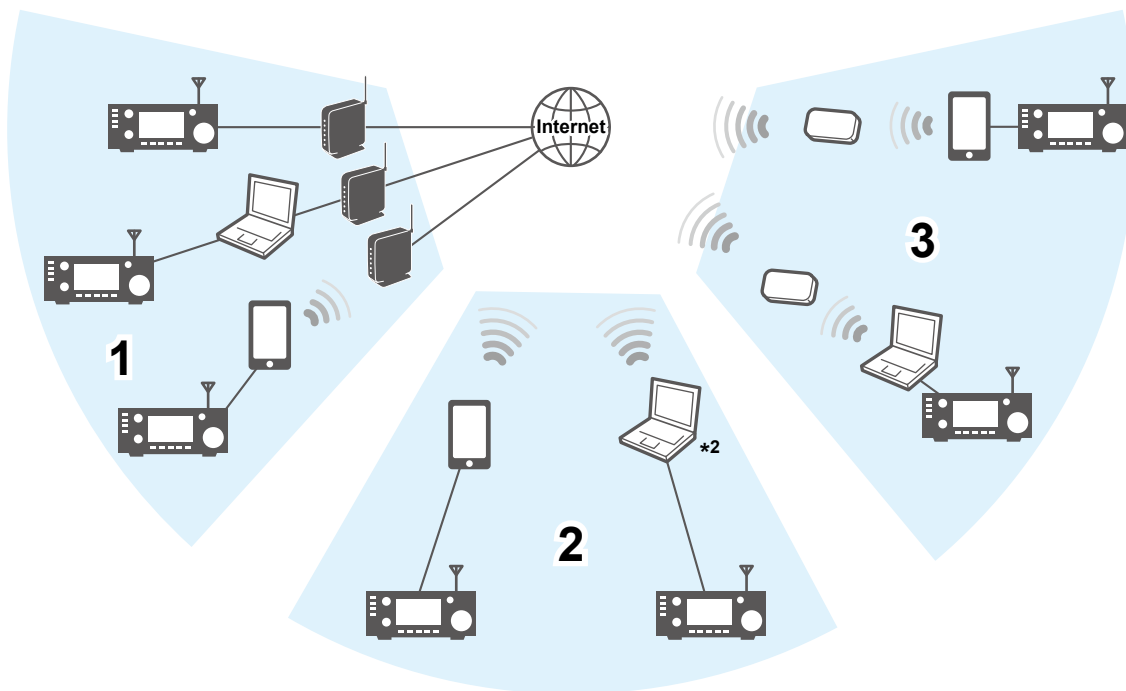

*2 You can use a cellular system compatible computer.

12. ABOUT THE DV GATEWAY FUNCTION

Setting up a network

About the UDP Hole Punch function

When both the caller station and the called station use the Terminal or Access Point mode, the caller station does not need to:

- Forward port 40000 when connecting to the Internet using the router.
- Use a device assigned a static or dynamic Global IP address.

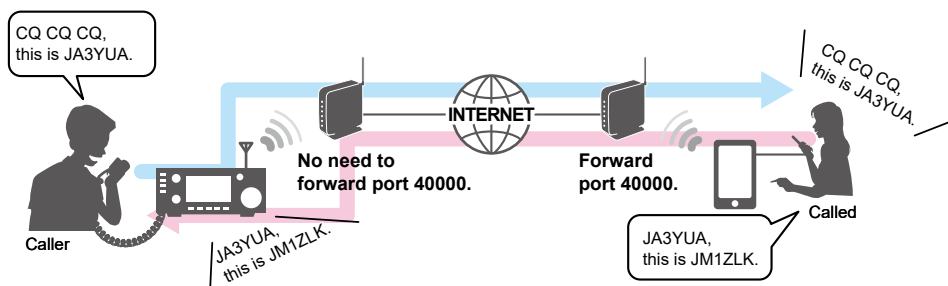

Information

- Depending on your Network environment, you may not be able to use this function.
- The caller station must set "UDP Hole Punch" to "ON" in the IC-9700 (When using the Internal Gateway function) or RS-MS3W/RS-MS3A (When using the External Gateway function) to use this function.

MENU » (2) > DV GW > Internal Gateway Settings > **UDP Hole Punch**

When not using this function, set "UDP Hole Punch" to "OFF."

- A few minutes* after the call, the caller station cannot receive from the called station. In this case, the caller station must transmit to the called station again.
- * Less than 3 minutes, depending on the router.

NOTE:

- When using the External Gateway function, use version 1.30 or later of the RS-MS3W/RS-MS3A application software.
- The caller station cannot communicate with the called station when:
 - The caller station is using an earlier version software or firmware.
 - The called station using an earlier version software or firmware.
 - The called station calls through a local repeater instead of using the Terminal or Access Point mode.
- Even if using the latest version, the called station needs to forward port 40000 when connecting to the Internet using a router, or to use a device assigned a static or dynamic Global IP address to communicate with the caller station.

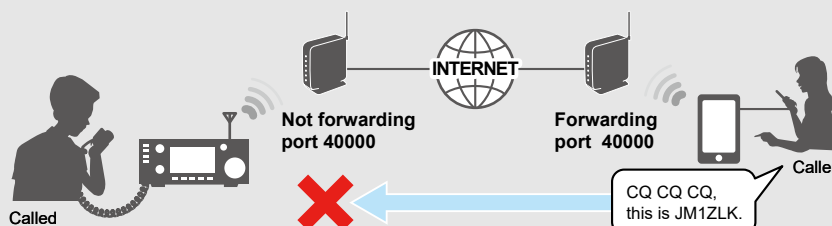

Setting up a network

◇ When connecting your device to the Internet using a router

The following items are needed to use the DV Gateway function.

- An Internet connection with an IPv4 Global IP address
- A static*1 local IP address set to your transceiver, Windows, or Android device
- Port forwarding of port 40000

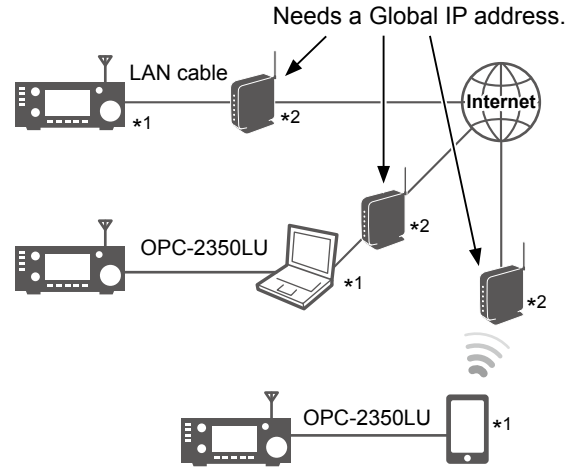

*1 A static IP address to the transceiver, Windows, or Android device is recommended.

*2 Forward port number 40000.

1. A Global IP address

A static or dynamic IPv4 Global IP address assigned to the router is needed.

- ① Your router may not have a Global IP address, depending on your Internet service provider. Ask your Internet service provider about the Global IP address setting.

2. Setting a static local IP address

When using a router, you need to set a static local IP address to the transceiver, Windows, or Android device.

- ① Usable IP addresses differ, depending on your router. Ask the router's manufacturer for details.
- ① Do not set the same IP address to two or more devices that are connected to the same router.
- ① Ask your Windows or Android device's manufacturer about the setting details.

Transceiver setting

When using the Internal Gateway function, open the NETWORK screen, and set these items.

- ① Ask your network administrator for details.

MENU » **SET > Network**

Items	Contents
DHCP	ON (Default) → OFF
IP Address	An IP address that is not assigned to any other device. Example: 192.168.0.10 (Default)
Subnet Mask	The subnet mask of the IP address Example: 255.255.255.0 (Default) ① Normally, use the default value.
Default Gateway	An IP address of the LAN side on the router Example: 192.168.0.1
Primary DNS Server	An IP address of the DNS Server. ① Normally, enter the default gateway IP address. Example: 192.168.0.1
2nd DNS Server	An IP address of the secondary DNS Server. ① Set this item if necessary.

12. ABOUT THE DV GATEWAY FUNCTION

Setting up a network

◇ When connecting your device to the Internet using a router (Continued)

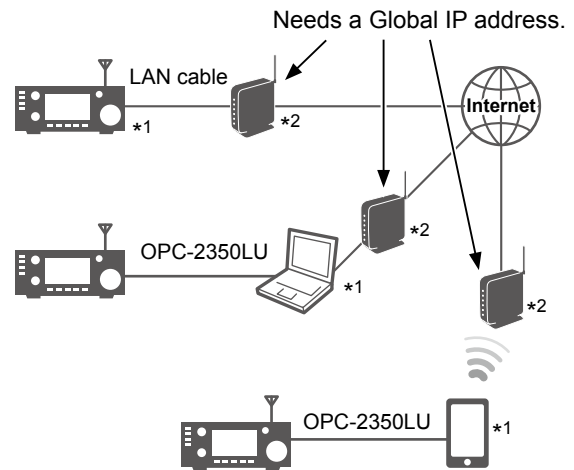

*1 A static IP address to the transceiver, Windows, or Android device is recommended.

*2 Forward port number 40000.

3. Port forwarding

When using a router, enable communication with the Internet, as described below.

- Forward the port number 40000 to the transceiver, Windows, or Android device.
 - “UDP” should be used as the port protocol.
 - Set a static local IP address in Procedure 2 (2. Setting a static local IP address) as a destination port.
- ① Ask the router’s manufacturer about how to forward the port.
 - ① Only one transceiver, Windows, or Android device connected to the router can use the DV Gateway function at the same time.
 - ① Depending on the router settings, you must configure the IP filter settings. Check the router’s manual on how to configure the settings.

→ When using the Internal Gateway function, go to “Setting up the transceiver.” (p. 12-10)

→ When using a Windows device, go to “Setting up the RS-MS3W.” (p. 12-12)

→ When using an Android device, go to “Setting up the RS-MS3A.” (p. 12-13)

12. ABOUT THE DV GATEWAY FUNCTION

Setting up a network

◇ When connecting your device to the Internet using a cellular system

A Global IP address is required to use the DV Gateway function.

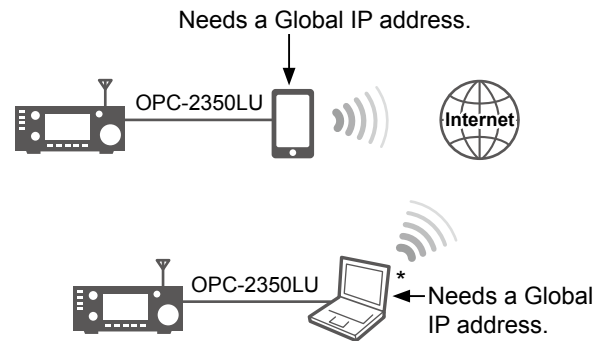

* You can use a cellular system compatible computer.

A Global IP address

A static or dynamic IPv4 Global IP address assigned to your Windows or Android device is needed. Ask your Internet service provider to provide a Global IP address to your device.

NOTE:

- Turn OFF your Wi-Fi setting when you operate using a cellular system.
- Communication errors may occur when using a cellular system.
- Depending on your contract, you may be charged a large or additional communication fee. Ask your cellular system company about the content of your contract.

→ When using a Windows device, go to “Setting up the RS-MS3W.” (p. 12-12)

→ When using an Android device, go to “Setting up the RS-MS3A.” (p. 12-13)

12. ABOUT THE DV GATEWAY FUNCTION

Setting up a network

◇ When connecting your device to the Internet using a mobile router

The following items are needed to use the DV Gateway function.

- An Internet connection with an IPv4 Global IP address
- A static*¹ local IP address set to your Windows or Android device
- Port forwarding of port 40000

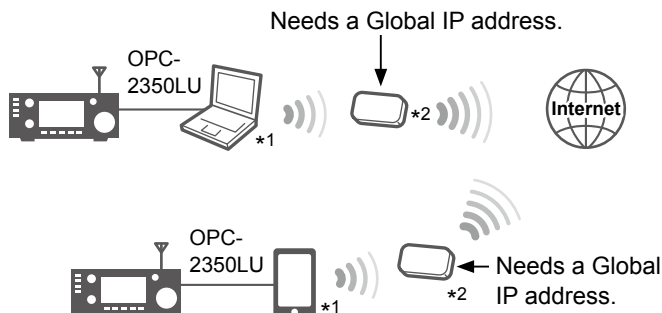

*¹ A static IP address to the transceiver, Windows, or Android device is recommended.

*² Forward port number 40000.

1. A Global IP address

A static or dynamic IPv4 Global IP address assigned to the mobile router is needed.

- ① Your router may not have a Global IP address, depending on your Internet service provider.
Ask your Internet service provider about the Global IP address setting.

2. Setting a static local IP address

When using a mobile router, you need to set a static local IP address to Windows or Android device.

- ① Usable IP addresses differ, depending on your router. Ask the router's manufacturer for details.
- ① Do not set the same IP address to two or more devices that are connected to the same router.
- ① Ask your Windows or Android device's manufacturer about the setting details.

3. Port forwarding

When using a mobile router, enable communication with the Internet, as described below.

- Forward the port number 40000 to your Windows or Android device.
- "UDP" should be used as the port protocol.
- Set a static local IP address in Procedure 2 (2. Setting a static local IP address to your device) as a destination port.
- ① Ask the router's manufacturer about how to forward the port.
- ① Only one Windows or Android device connected to the router can use the DV Gateway function at the same time.
- ① Depending on the router settings, you may need to configure the IP filter settings. Check the router's manual on how to configure the settings.

→ When using a Windows device, go to "Setting up the RS-MS3W." (p. 12-12)

→ When using an Android device, go to "Setting up the RS-MS3A." (p. 12-13)

Setting up the device

◇ When using the Internal Gateway function

Connecting the LAN cable

Connect the transceiver to the router using the LAN cable.

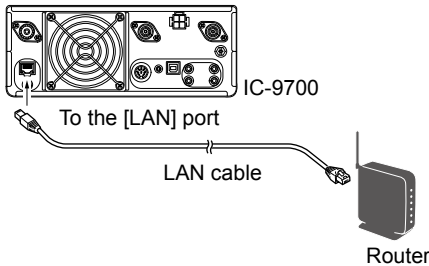

Setting the Internal Gateway Settings

1. Open the INTERNAL GATEWAY SETTINGS screen.

MENU » (2) > DV GW > Internal Gateway Settings

2. Touch to select the item to set.
(Example: "Terminal/AP Call sign")

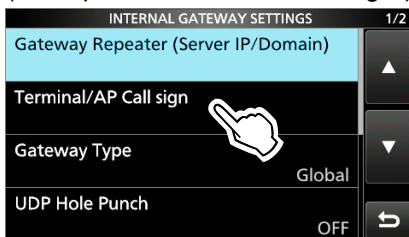

3. Enter a call sign, and then touch [ENT].
① See right for details on the setting items and their options.

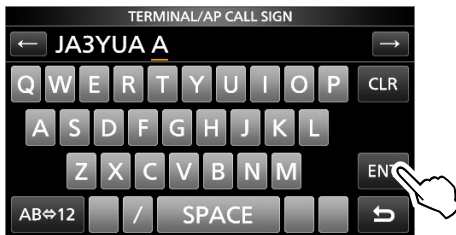

4. To close the INTERNAL GATEWAY SETTINGS screen, push **EXIT** several times.

Gateway Repeater (Server IP/Domain)

Enter the RS-RP3C's gateway repeater address or domain name.

- ① The address consists of up to 64 characters.

NOTE: You must have your call sign registered to the gateway server that has the RS-RP3C installed. Ask the gateway repeater administrator for details.

Terminal/AP Call sign

Enter the Terminal/AP call sign that is registered as the access point on the RS-RP3C's Personal Information screen.

- ① The call sign consists of 8 characters.
- ① Enter a desired ID suffix between A to Z, except for G, I, and S, for the 8th character.

Gateway Type (Default: Global)

Select the gateway type.

- ① Select "Global" when operating outside of Japan.

UDP Hole Punch (Default: OFF)

Selects whether or not to use the UDP Hole Punch function. This function enables you to communicate with other station who uses the Terminal or Access Point mode even if you do not forward port 40000 of a router. (p. 12-5)

Allowed Call Sign (Access Point Mode) (Default: Disable)

Select to use the call sign restriction for the Access Point mode. When "Enable" is selected, this allows only stations with registered call signs to transmit through the Internet.

- Disable: Allows all call signs to transmit.
- Enable: Allows only the call sign entered on the "Allowed Call sign List" to transmit. (See the next page.)

- ① When using the Terminal mode, select "Disable."

12. ABOUT THE DV GATEWAY FUNCTION

Setting up the device

◇ When using the Internal Gateway function

Allowed Call Sign List

Enter the call sign of the stations that you allow to transmit through the Internet while “Enable” is selected for “Allowed Call sign (Access Point Mode).”

① You can add up to 30 call signs.

Adding a call sign

1. Touch for 1 second.



2. Touch “Add.”

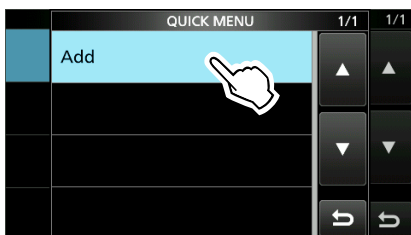

3. Enter the Call sign, and then touch [ENT].

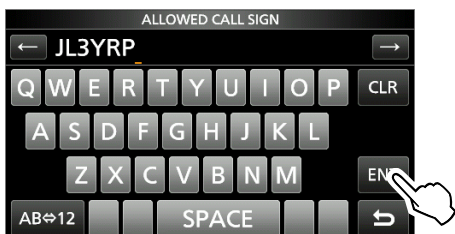

Deleting a call sign

1. Touch the Call sign for 1 second to open the QUICK MENU.



2. Touch “Delete.”

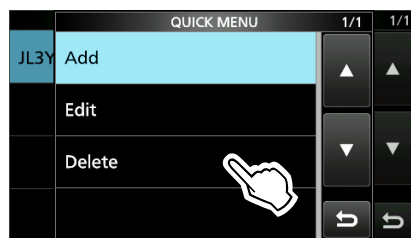

3. Touch [YES].

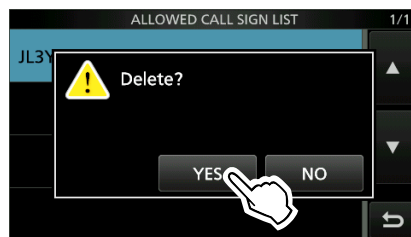

12. ABOUT THE DV GATEWAY FUNCTION

Setting up the device

◇ When using the RS-MS3W software

The RS-MS3W is a Windows application to use with the External Gateway function.

You can download it from the Icom website.

System requirements

The following are required to use the RS-MS3W.
(As of May 2023)

- **Operating System (OS)**

Microsoft Windows 10 (32/64bit)

Microsoft Windows 11 (64bit)

① Except for Windows on ARM

- **USB port**

USB 1.1 or 2.0 port

- **Data cable**

OPC-2350LU DATA CABLE (purchase separately)

NOTE: Before using the data cable, you have to install its USB driver. The latest USB driver and Installation Guide for the OPC-2350LU can be downloaded from “Options” section towards the bottom of the firmware page on the Icom website. Carefully read the guide, before installing the driver.
<https://www.icomjapan.com/support/>

Installing the RS-MS3W

Download the latest RS-MS3W and its instruction manual from the Icom website.

Read the RS-MS3W instruction manual on how to install the software.

① Search by “RS-MS3W.”

<https://www.icomjapan.com/support/>

Connecting the OPC-2350LU

Connect the transceiver to the Windows device using the OPC-2350LU.

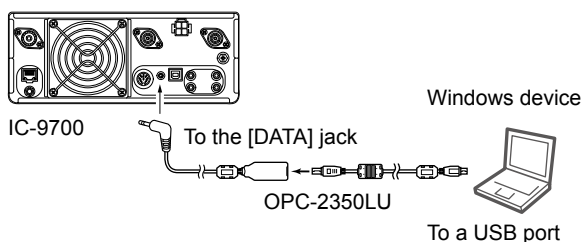

NOTE: Turn OFF the transceiver before connecting or disconnecting the cable.

COM port settings

Set the data port.

1. After connecting, turn ON the transceiver.
2. Click “Com Port (P)” in the “Settings (S).”
 - The Com Port Setting window is displayed.
3. Select the COM port number that the data cable is connected to.
 - ① Click “▼” to display the COM ports on a drop-down list.
 - ① See the data cable’s Installation Guide that you can download on the Icom website, for details on checking the COM port number.
4. Click <OK>.

Setting the RS-MS3W

Set the RS-MS3W to start using the DV Gateway function.

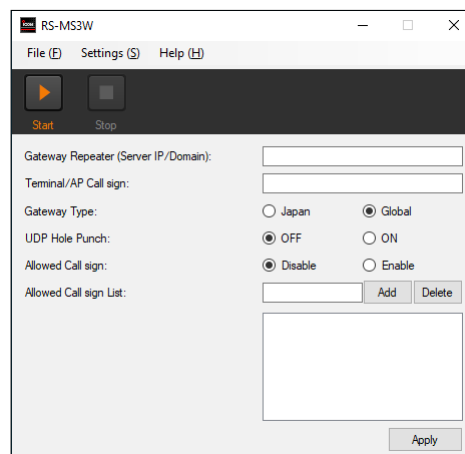

① The screen may be different, depending on the application version.

Read the RS-MS3W instruction manual about each setting item.

NOTE: About the Firewall setting

When you use a firewall security software, a communication error may occur by the firewall blocking the necessary ports or data.

Before using the DV Gateway function, confirm that the RS-MS3W’s communication is not blocked.

① Ask your firewall security software’s manufacturer about the setting details.

12. ABOUT THE DV GATEWAY FUNCTION

Setting up the device

◇ When using the RS-MS3A

The RS-MS3A is an application for Android device to use the External Gateway function.
Download the application from Google Play.

System requirements

The following are required to use the RS-MS3A.
(As of May 2023)

• Android device

Android 5.0 or later with the USB host function

- ① The RS-MS3A has been tested with Android 5.x.x, 6.x.x, 7.x.x, 8.x, 9, 10, 11, and 12.

TIP: The USB host function is needed to use a USB device with an Android device. To check whether or not your Android device has the USB host system, ask the Android device's manufacturer.

• Data cable

OPC-2350LU DATA CABLE (purchase separately)

NOTE:

Some functions may not be usable, depending on:

- applications installed in the Android device
- memory capacity

For operations or settings of the Android device, read the Android device's instruction manual.

- ① Display indications may differ, depending on the OS version or settings.

Installing the RS-MS3A

1. Start the Android device.
2. Touch "Play Store."
3. Enter "RS-MS3A."
 - ① Do not abbreviate the application name to search.
4. Touch "🔍 (search)."
5. Touch "RS-MS3A."
 - The RS-MS3A application information is displayed.
 - ① If your Android device is not compatible with the RS-MS3A, the application is not displayed.
6. Touch "Install."
7. Touch "Agree to download."
 - Starts installing the application.
 - After the installation is completed, the icon is displayed on your home screen.

Connecting the OPC-2350LU

Connect the transceiver to the Android device using the OPC-2350LU.

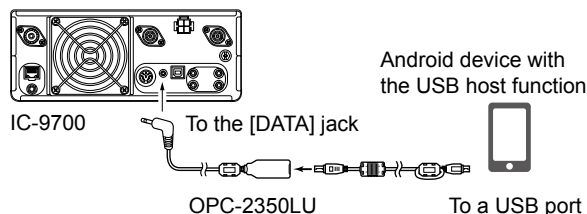

NOTE:

- Turn OFF the transceiver before connecting or disconnecting the cable.
- Remove the OPC-2350LU when you do not use the cable. Otherwise, the battery will be quickly exhausted.
- If the application selection window is displayed, select "RS-MS3A" to start the application.
- If your Android device has a USB Type-C port, you need a USB On-The-Go (OTG) adapter to convert the data cable's plug to USB Type-C.

Setting the RS-MS3A

Set the RS-MS3A to start using the DV Gateway function.

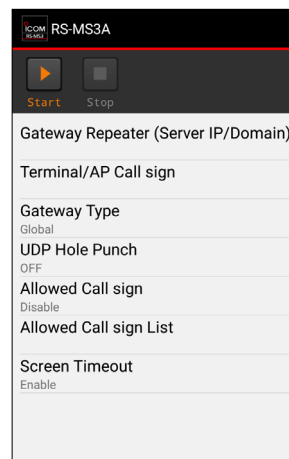

- ① The screen may be different, depending on the application version.

Read the RS-MS3A instruction manual about each setting item.

- ① Search by "RS-MS3A."

<https://www.icomjapan.com/support/>

Terminal mode operation

◇ Setting the Terminal mode

1. Open the DV GATEWAY screen.

MENU » **(2)** > **DV GW**

2. Touch “<<Terminal Mode>>.”

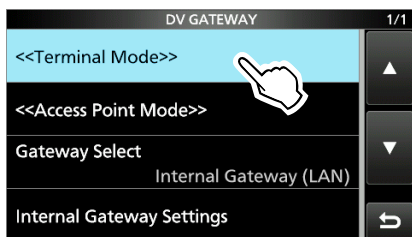

Internal Gateway icon

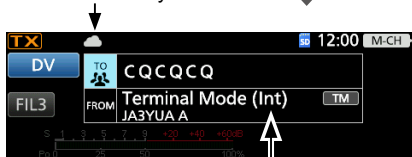

“Ext” is displayed when using the External Gateway function.

When using the External Gateway function

After the transceiver is in the Terminal mode, click (touch) <Start>  in the RS-MS3W or RS-MS3A.

① If an error message is displayed, see page 12-26 to read the tips to solve the problem.

NOTE: In the Terminal mode

- The Time Out Timer function is not activated.
- The following items are automatically set.
 Mode: DV mode*
 DR function: ON (MAIN band)*
 FROM: MY Call Sign
 Dualwatch function: OFF*
 AFC function: OFF
 RIT function: OFF
 P.AMP function: OFF
 EXT P.AMP function: OFF
 ATT function: OFF
 IP+ function: OFF
 TX PWR LIMIT function: OFF
- * These settings do not return to the previous settings, even if you cancel the Terminal mode.
- The Terminal mode is not automatically canceled, even if you turn OFF the transceiver, then turn it ON again.

TIP: Canceling the Terminal mode

Touch “<<Normal Mode>>” in the QUICK MENU or the DV GATEWAY screen.









MENU » **(2)** > **DV GW** > **<<Normal Mode>>**

① To display the QUICK MENU screen, push **QUICK**.

① When using the External Gateway function, click (touch) <Stop>  in the RS-MS3W or RS-MS3A before the transceiver returns to the normal mode.

About the Internal Gateway icon

When using the Internal Gateway function, displays the communication status.

Icon	Status
	In the standby mode
	While transmitting
	While receiving
	Transmission error (The repeater is busy.)
	Transmission error
	Network error
	Receiving while transmitting
	Receive error

① If an error icon is displayed, see page 12-21 to read the tips to solve the problem.

Terminal mode operation

◇ Operating in the Terminal mode

NOTE: In the Terminal mode, you can make a Gateway CQ call, or a call to a specific station, using call sign routing.
 ⓘ You cannot make a call if you select “Local CQ” or “Reflector.”

Example: Making a Gateway CQ call

1. Touch “TO.”

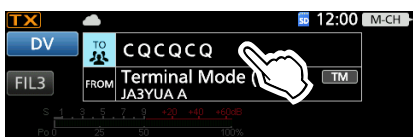

2. Touch “Gateway CQ.”

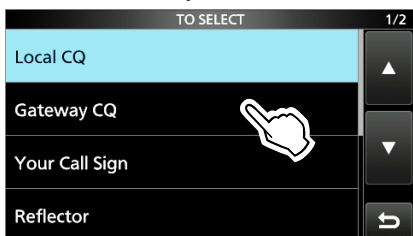

3. Select the repeater group where your destination repeater is listed.



4. Select your destination repeater. (Example: Hirano/Icom)
 - Returns to the DR screen, and selected repeater name is set in “TO.”



5. Push **TRANSMIT**, or hold down the microphone’s [PTT] to transmit.
 - While transmitting, the TX/RX indicator lights orange.
 - ⓘ While receiving a signal through the Internet, you cannot transmit.
 - ⓘ If you cannot receive a reply, see page 12-22 to read the tips to solve the problem.

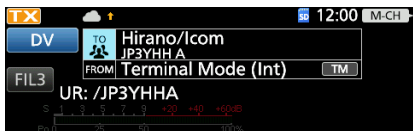

Example: Making a call to a specific station

1. Touch “TO.”

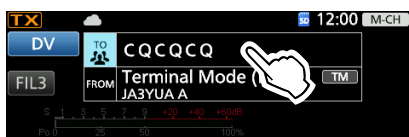

2. Touch “Your Call Sign.”

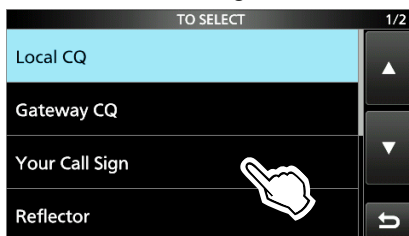

3. Select your destination station. (Example: Rick)
 - Returns to the DR screen, and the selected name is set in “TO.”

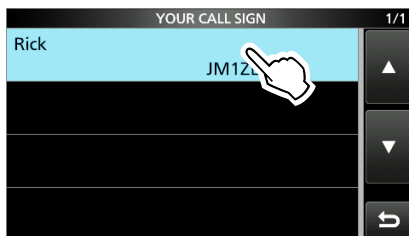

4. Push **TRANSMIT**, or hold down the microphone’s [PTT] to transmit.
 - While transmitting, the TX/RX indicator lights orange.
 - ⓘ While receiving a signal through the Internet, you cannot transmit.
 - ⓘ If you cannot receive a reply, see page 12-22 to read the tips to solve the problem.

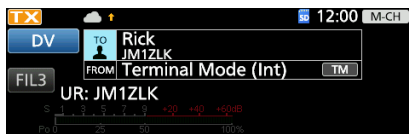

Access Point mode operation

◇ Setting the Access Point mode

In this section, set an Access Point transceiver.

1. Open the DV GATEWAY screen.

MENU » (2) > **DV GW**

2. Touch “<<Access Point Mode>>.”

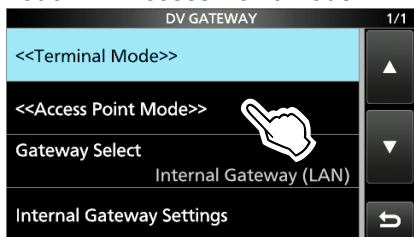

Internal Gateway icon

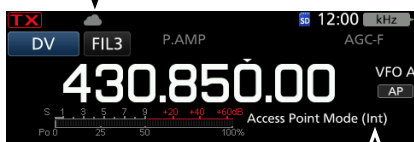

“Ext” is displayed when using the External Gateway function.

3. Rotate **MAIN DIAL** to set the operating frequency.

① The frequency is used to communicate with the Remote D-STAR transceiver.

① In the Access Point mode, you can change the operating frequency.

NOTE: BE SURE to check your local regulations or laws to select the appropriate operating frequency.

When using the External Gateway function

After the transceiver is in the Access Point mode, click (touch) <Start> in the RS-MS3W or RS-MS3A.

① If an error message is displayed, see page 12-26 to read the tips to solve the problem.

NOTE: In the Access Point mode

- The following items are automatically set.
 Mode: VFO mode*
 Operating mode: DV mode*
 Dualwatch function: OFF*
 Duplex mode: OFF*
 AFC function: OFF
 RIT function: OFF
 VOX function: OFF
 MONITOR function: OFF
 * These settings do not return to the previous settings, even if you cancel the Access Point mode.
- The Access Point mode is not automatically canceled even if you turn OFF the transceiver, then turn it ON again.

TIP: Canceling the Access Point mode

Touch “<<Normal Mode>>” in the QUICK MENU or the DV GATEWAY screen.

MENU » (2) > DV GW > <<Normal Mode>>

① To display the QUICK MENU screen, push **QUICK**.

① When using the External Gateway function, click (touch) <Stop> in the RS-MS3W or RS-MS3A before the transceiver returns to the normal mode.

About the Internal Gateway icon

When using the Internal Gateway function, displays the communication status.

Icon	Status
	In the standby mode
	While transmitting
	While receiving
	Transmission error (The repeater is busy.)
	Transmission error
	Network error
	Receiving while transmitting
	Receive error

① If an error icon is displayed, see page 12-21 to read the tips to solve the problem.

Access Point mode operation

◇ Making a Gateway call through the Access point transceiver

In this section, set up a Remote D-STAR transceiver you are going to operate.

① Read the Remote D-STAR transceiver’s instruction manual for setting details.

NOTE: While in the Access Point mode, you can make a Gateway CQ call or a call to an individual station using call sign routing.
 ① You can select the “Local CQ,” but cannot make a call.

Example: When setting the operating frequency to 430.850 MHz, and making a Gateway CQ call.

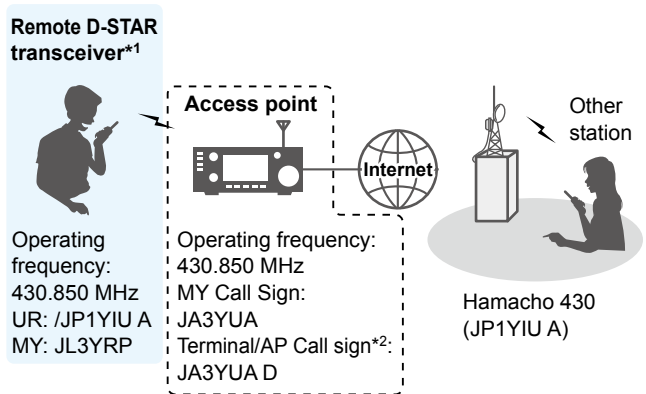

*1 Any model as long as the transceiver is D-STAR capable. Only one D-STAR transceiver can use the Access Point at a same time.

*2 When you use the External Gateway function, enter the Call sign in “Terminal/AP Call sign” in the RS-MS3W or RS-MS3A.

When using the DR function

NOTE: If you have imported the Repeater List, you have to register the Access Point information again because the Repeater List is overwritten.

In this document, the ID-51A (PLUS2)/ID-51E (PLUS2) is used as a Remote D-STAR transceiver as an example.

1. Register the Access Point information to the Repeater List

① Register the Access Point information in the MENU screen.
 (MENU > DV Memory > **Repeater List**)

1. Select a group you want to add your Access Point information to.
2. After selecting a group, open the Repeater List Edit screen. (QUICK MENU > **Add**)

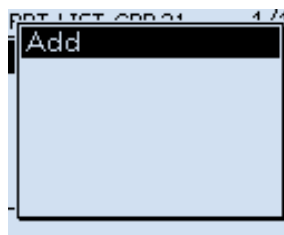

3. Set “DV Repeater” to “TYPE.”
 ① “DV Repeater” is used for Repeater operation in the DV mode.
4. Enter your favorite name into “NAME” and “SUB NAME.” (Example: MY AP)

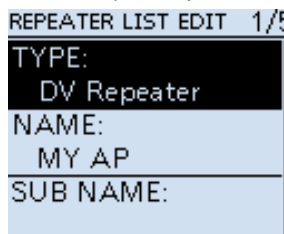

5. Set the Access Point transceiver’s call sign to “CALL SIGN.” (Example: JL3YRP)
 ① After setting “CALL SIGN,” “GW CALL SIGN” is automatically set.



12. ABOUT THE DV GATEWAY FUNCTION

Access Point mode operation

◇ Making a Gateway call through the Access point transceiver

When using the DR function

1. Register the Access Point information to the Repeater List (Continued)

6. Set "YES" to "USE (FROM)."
7. Set the Access Point transceiver's operating frequency to "FREQUENCY." (Example: 430.850)
8. Set "DUP" to "DUP-."

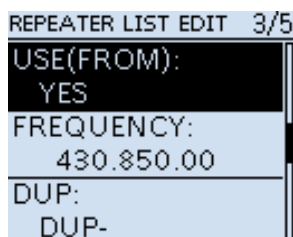

9. Set "0.000.00" to "OFFSET FREQ."

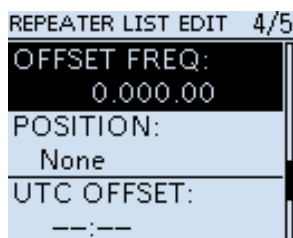

10. Select "<<Add Write>>" and write the Access Point information.

2. Set the Access Point using the DR function

Set the Access Point registered in Procedure 1 (1. Register the Access Point information to the Repeater List) to "FROM."

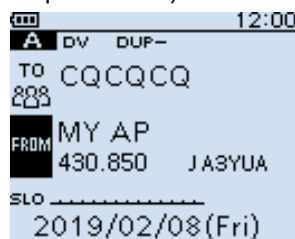

3. Set "TO" and transmit

1. Set "TO" destination. (Example: Hamacho 430)
① You can select the "Local CQ," but cannot make a call.

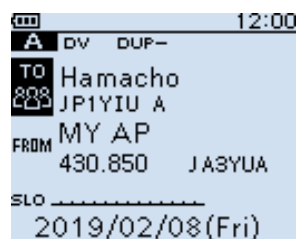

2. Hold down [PTT] to transmit.
① If you cannot receive a reply, see page 12-24 to read the tips to solve the problem.

12. ABOUT THE DV GATEWAY FUNCTION

Access Point mode operation

◇ Making a Gateway call through the Access point transceiver

When not using the DR function

In this document, the ID-51A (PLUS2)/ID-51E (PLUS2) is used as a Remote D-STAR transceiver as an example.

1. Enter the VFO mode

Push [V/MHz].

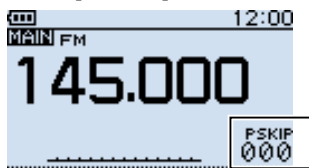

2. Set the operating frequency

Rotate [DIAL] to set the frequency that is set in the Access Point transceiver. (Example: 430.850)

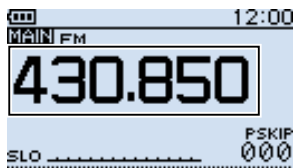

3. Set the Receive mode to "DV mode"

Push [MODE] several times until "DV" is displayed.
① When the "GPS TX Mode" is set, "DV-G" or "DV-A" is displayed.

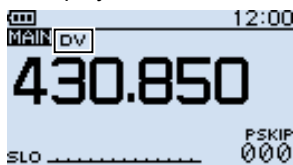

4. Set the duplex direction

1. Push [QUICK].
2. Select "DUP."

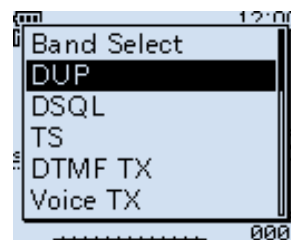

3. Select "DUP-."

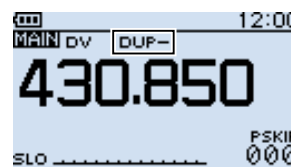
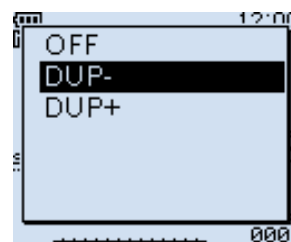

12. ABOUT THE DV GATEWAY FUNCTION

Access Point mode operation

◇ Making a Gateway call through the Access point transceiver

When not using the DR function (Continued)

5. Set the frequency offset

1. Push [MENU].
2. Select "DUP/TONE...."

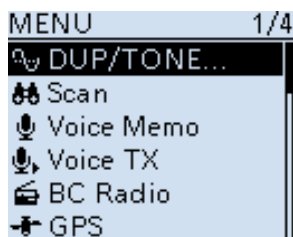

3. Select "Offset Freq."

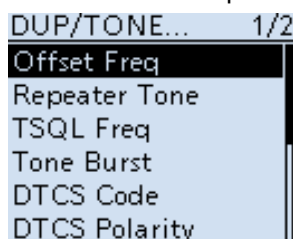

4. Set "0.000.00."

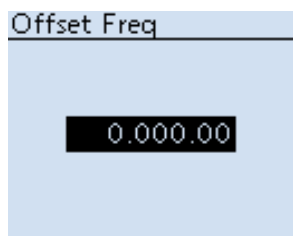

5. Push [MENU].
 - Returns to the standby screen.

6. Set the destination station call sign to "UR"

1. Hold down [CS] for 1 second to enter the Operating Call Sign Select mode.
2. Select "UR."
3. Set the destination repeater or destination station's call sign.
 - ① In the Access Point mode, you can select the "CQCQCQ" but cannot make a call.

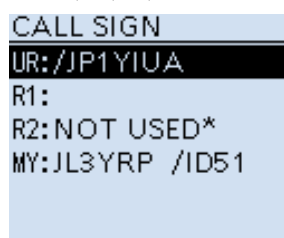

4. Push [MENU].
 - Returns to the standby screen.

7. Hold down [PTT] to transmit





- ① If you cannot receive a reply, see page 12-24 to read the tips to solve the problem.

TIP: When the settings are saved into a memory channel, you can quickly select the settings. Read the Remote D-STAR transceiver's instruction manual for details.

Troubleshooting

◇ Error icon of the transceiver

If an error icon is displayed when using the Internal Gateway function, read the following chart. If you are unable to locate the cause of a problem or solve it through the use of this chart, contact your Icom Dealer or Service Center.

ICON	POSSIBLE CAUSE	SOLUTION	REFERENCE
	<ul style="list-style-type: none"> • Transceiver connection is wrong. • Gateway Repeater cannot be found. 	<ul style="list-style-type: none"> • Check the connection between the transceiver and the router. • Check the NETWORK settings. 	<p>p. 12-10</p> <p>p. 12-6</p>
	<ul style="list-style-type: none"> • The call sign has not been added to "Allowed Call Sign List" in the transceiver, when "Allowed Call Sign" is set to "Enable." • Your call sign (MY) has not been registered at a gateway server. • The Terminal/AP call sign that is set in the transceiver has not been registered to the RS-RP3C as the access point. • Destination station's call sign (UR) has not been registered to the gateway server, or the registered contents do not match your transceiver's setting. • Destination station that uses the Terminal mode or Access Point mode does not transmit periodically. 	<ul style="list-style-type: none"> • Set "Allowed Call Sign" to "Disable" in the INTERNAL GATEWAY SETTINGS screen. • Add the Remote D-STAR transceiver's call sign to "Allowed Call Sign List" in the INTERNAL GATEWAY SETTINGS screen. • Register your call sign (MY) at a gateway server. • Register the Terminal/AP call sign that is set in the transceiver to the RS-RP3C as the access point. • Check the destination station's register information. • Destination station makes a call. 	<p>p. 12-10</p> <p>p. 12-11</p> <p>—</p> <p>p. 12-10</p> <p>—</p> <p>—</p>
	<ul style="list-style-type: none"> • The repeater is busy. 	<ul style="list-style-type: none"> • Wait for a while, and try again. 	—
	<ul style="list-style-type: none"> • A signal is received while transmitting. 	<ul style="list-style-type: none"> • Destination station makes a call again. 	—
	<ul style="list-style-type: none"> • The transceiver cannot receive the signal. 	<ul style="list-style-type: none"> • Destination station makes a call again. 	—



12. ABOUT THE DV GATEWAY FUNCTION

Troubleshooting

◇ Troubleshooting for the Terminal mode operation

The following chart is designed to help you correct problems which are not equipment malfunctions.

If you are unable to locate the cause of a problem or solve it through the use of this chart, contact your Icom Dealer or Service Center.

PROBLEM	POSSIBLE CAUSE	SOLUTION	REFERENCE
After your call, the repeater does not return a status reply.	<ul style="list-style-type: none"> Transceiver connection is wrong. “Allowed Call Sign” is set to “Enable.” When using the External Gateway function, you did not click (touch) <Start>  in the RS-MS3W or RS-MS3A. 	<ul style="list-style-type: none"> When using the Internal Gateway function, check the connection between the transceiver and the router. When using the External Gateway function, check the connection between the transceiver and the Windows device, or the transceiver and the Android device. When using the Internal Gateway function, set “Disable” to “Allowed Call Sign” in the INTERNAL GATEWAY SETTINGS screen. When using the External Gateway function, set “Disable” to “Allowed Call Sign” in the RS-MS3W or RS-MS3A. Click (touch) <Start>  in the RS-MS3W or RS-MS3A. 	<p>p. 12-10</p> <p>pp.12-12,12-13</p> <p>p. 12-10</p> <p>RS-MS3W, RS-MS3A's instruction manual</p> <p>RS-MS3W, RS-MS3A's instruction manual</p>
After your call, the repeater replies “UR?,” Your own call sign (MY) and ID suffix “G.”	<ul style="list-style-type: none"> The call was successfully sent, but no station immediately replied. 	<ul style="list-style-type: none"> Wait for a while, and try again. 	–
After your call, the repeater replies “RX” or “RPT?” and Your own call sign (MY) and ID suffix “G.”	<ul style="list-style-type: none"> Your call sign (MY) has not been registered at a gateway server. The Terminal/AP call sign that is set in the transceiver, RS-MS3A, or RS-MS3W has not been registered to the RS-RP3C as the access point. Destination station’s call sign (UR) has not been registered to the gateway server, or the registered contents do not match your transceiver’s setting. Destination station that uses the Terminal mode or Access Point mode does not transmit periodically. 	<ul style="list-style-type: none"> Register your call sign (MY) at a gateway server. When using the Internal Gateway function, register the Terminal/AP call sign that is set in the transceiver to the RS-RP3C as the access point. When using the External Gateway function, register the Terminal/AP call sign that is set in the RS-MS3A or RS-MS3W to the RS-RP3C as the access point. Check the destination station’s register information. Destination station makes a call. 	<p>–</p> <p>p. 12-10</p> <p>RS-MS3W, RS-MS3A's instruction manual</p> <p>–</p> <p>–</p>
After your call, the repeater replies ‘RPT?’ and the access repeater’s call sign.	<ul style="list-style-type: none"> The repeater cannot connect to the destination repeater. The repeater is busy. 	<ul style="list-style-type: none"> Wait for a while, and try again. 	–
“L” appears on the LCD.	<ul style="list-style-type: none"> While receiving through the Internet, some packets may be lost due to network error (poor data throughput performance). 	<ul style="list-style-type: none"> Wait for a while, and try again. ① When the transceiver receives corrupted data, and misidentifies it as Packet Loss, “L” is displayed. 	–

12. ABOUT THE DV GATEWAY FUNCTION

Troubleshooting

◇ Troubleshooting for the Terminal mode operation

PROBLEM	POSSIBLE CAUSE	SOLUTION	REFERENCE
You can transmit, but cannot receive from the destination repeater.	<ul style="list-style-type: none">• A Global IP address is not used.• The router or mobile router's port is not correctly forwarded.• The firewall is blocking the necessary port.	<ul style="list-style-type: none">• Check the Internet connection and use a Global IP address.• Forward the router or mobile router's correct port.• Check your firewall settings.	<p>pp. 12-6 ~ 12-9</p> <p>pp. 12-6, 12-9</p> <p>p. 12-12</p>



12. ABOUT THE DV GATEWAY FUNCTION

Troubleshooting

◇ Troubleshooting for the Access Point mode operation

The following chart is designed to help you correct problems which are not equipment malfunctions.

If you are unable to locate the cause of a problem or solve it through the use of this chart, contact your Icom Dealer or Service Center.

PROBLEM	POSSIBLE CAUSE	SOLUTION	REFERENCE
After your call, the repeater does not return a status reply. (No S-meter indication)	<ul style="list-style-type: none"> The wrong Access Point is selected in the Remote D-STAR transceiver. The manually entered frequency or duplex setting is wrong in the Remote D-STAR transceiver. The transmission from the Remote D-STAR transceiver did not reach the Access Point. Transceiver connection is wrong. The Remote D-STAR transceiver's call sign has not been added to "Allowed Call Sign List" in the transceiver, RS-MS3W, or RS-MS3A, when "Allowed Call sign" is set to "Enable." When using the External Gateway function, you did not click (touch) <Start>  in the RS-MS3W or RS-MS3A. 	<ul style="list-style-type: none"> Set the correct Access Point to "FROM." Set the correct frequency or duplex setting. Move to the place where the Remote D-STAR transceiver can reach the Access Point. When using the Internal Gateway function, check the connection between the transceiver and the router. When using the External Gateway function, check the connection between the transceiver and the Windows device, or the transceiver and the Android device. When using the Internal Gateway function, add the Remote D-STAR transceiver's call sign to "Allowed Call Sign List" in the INTERNAL GATEWAY SETTINGS screen. When using the External Gateway function, add the Remote D-STAR transceiver's call sign to "Allowed Call Sign List" in the RS-MS3W or RS-MS3A. Click (touch) <Start>  in the RS-MS3W or RS-MS3A. 	<p>–</p> <p>–</p> <p>–</p> <p>p. 12-10</p> <p>pp.12-12,12-13</p> <p>p. 12-10</p> <p>RS-MS3W, RS-MS3A's instruction manual</p> <p>RS-MS3W, RS-MS3A's instruction manual</p>
After your call, the repeater replies "UR?," the Access Point call sign and ID suffix "G."	<ul style="list-style-type: none"> The call was successfully sent to the Access Point, but no station immediately replied. 	<ul style="list-style-type: none"> Wait for a while, and try again. 	<p>–</p>

12. ABOUT THE DV GATEWAY FUNCTION

Troubleshooting

◇ Troubleshooting for the Access Point mode operation

PROBLEM	POSSIBLE CAUSE	SOLUTION	REFERENCE
After your call, the repeater replies "RX" or "RPT?" and the Access Point call sign and ID suffix "G."	<ul style="list-style-type: none"> The Remote D-STAR transceiver's call sign has not been set to the transceiver. The Remote D-STAR transceiver's call sign has not been registered at a gateway server. The Terminal/AP call sign that is set in the transceiver, RS-MS3A, or RS-MS3W has not been registered to the RS-RP3C as the access point. Destination station's call sign (UR) has not been registered to the gateway server, or the registered contents do not match your transceiver's setting. A wrong destination repeater's call sign is set to "TO." The settings are wrong. Destination station that uses the Terminal mode or Access Point mode does not transmit periodically. 	<ul style="list-style-type: none"> Set the Remote transceiver's call sign has not been set to the transceiver. Register The Remote D-STAR transceiver's call sign at a gateway server. When using the Internal Gateway function, register the Terminal/AP call sign that is set in the transceiver to the RS-RP3C as the access point. When using the External Gateway function, register the Terminal/AP call sign that is set in the RS-MS3A or RS-MS3W to the RS-RP3C as the access point. Check the destination station's register information. Set the correct destination repeater's call sign to "TO." When using the Internal Gateway function, correctly set the transceiver's Internal Gateway settings. When using the External Gateway function correctly set the RS-MS3W or the RS-MS3A. Destination station makes a call. 	<p>The Remote D-STAR transceiver's instruction manual</p> <p>p. 12-10</p> <p>RS-MS3W, RS-MS3A's instruction manual</p> <p>—</p> <p>p. 12-17</p> <p>p. 12-10</p> <p>RS-MS3W, RS-MS3A's instruction manual</p> <p>—</p>
After your call, the repeater replies 'RPT?' and the access repeater's call sign.	<ul style="list-style-type: none"> The repeater cannot connect to the destination repeater. The repeater is busy. 	<ul style="list-style-type: none"> Wait for a while, and try again. 	—
"L" appears on the LCD.	<ul style="list-style-type: none"> While receiving through the Internet, some packets may be lost due to network error (poor data throughput performance). 	<ul style="list-style-type: none"> Wait for a while, and try again. ① When the transceiver receives corrupted data, and misidentifies it is as Packet Loss, "L" is displayed. 	—
"DV" and "FM" icons alternately blink.	<ul style="list-style-type: none"> While in the DV mode, an FM signal is received. 	<ul style="list-style-type: none"> Use a different operating frequency until there are no FM signals on the original frequency. 	—
You can transmit, but cannot receive from the destination repeater.	<ul style="list-style-type: none"> A Global IP address is not used. The router or mobile router's port is not correctly forwarded. The firewall is blocking the necessary port. 	<ul style="list-style-type: none"> Check the Internet connection and use a Global IP address. Forward the router or mobile router's correct port. Check your firewall settings. 	<p>pp. 12-6 ~ 12-9</p> <p>pp. 12-6, 12-9</p> <p>p. 12-12</p>

12. ABOUT THE DV GATEWAY FUNCTION

Troubleshooting

◇ Error messages of the RS-MS3W and the RS-MS3A

If an error message is displayed when clicking (touching) <Start>  in the RS-MS3W or RS-MS3A, read the following chart. If you are unable to locate the cause of a problem or solve it through the use of this chart, contact your Icom Dealer or Service Center.

MESSAGE	POSSIBLE CAUSE	SOLUTION	REFERENCE
Gateway Repeater (Server IP/Domain) cannot be found.	<ul style="list-style-type: none"> The gateway repeater address is not correctly entered. Your Windows or Android device does not connect to the Internet. 	<ul style="list-style-type: none"> Correctly enter the gateway repeater address. Connect your Windows or Android device to the Internet, and check whether or not you can access to a web site on the www browser. 	RS-MS3W, RS-MS3A's instruction manual —
Terminal/AP Call sign is incorrect.	<ul style="list-style-type: none"> The Terminal/AP call sign is not correctly entered. 	<ul style="list-style-type: none"> Correctly enter the call sign. ① The call sign consists of 8 characters. <ul style="list-style-type: none"> Enter a space before the character. Enter a desired ID suffix between A to F for the 8th character. 	RS-MS3W, RS-MS3A's instruction manual
The USB cable is not connected.(1 * *)	<ul style="list-style-type: none"> Transceiver connection is wrong. 	<ul style="list-style-type: none"> Check the connection between the transceiver and the Windows device, or the transceiver and the Android device. 	pp.12-12,12-13
The USB cable is not connected.(2 * *)	<ul style="list-style-type: none"> The transceiver is not turned ON. The transceiver is in the Normal mode. 	<ul style="list-style-type: none"> Turn ON the transceiver. Enter the Terminal mode or Access Point mode. 	— pp.12-14,12-16
Failed to connect to the network.	<ul style="list-style-type: none"> The application cannot create a socket for sending and receiving data. 	<ul style="list-style-type: none"> Check whether or not the port number (40000/40002) competes with other application. If so, stop the competing application. Restart the RS-MS3W or RS-MS3A. If an error message does not disappear, restart Windows or Android device. 	— —
A Network error occurred.	<ul style="list-style-type: none"> System error occurs when receiving data from network. 	<ul style="list-style-type: none"> Restart the RS-MS3W or RS-MS3A. If an error message does not disappear, restart Windows or Android device. 	—
Failed to start the service.	<ul style="list-style-type: none"> The gateway repeater address or Terminal/AP call sign is not correctly entered. System error occurs when the service started. 	<ul style="list-style-type: none"> Correctly enter the gateway repeater address or Terminal/AP call sign. Restart the RS-MS3W or RS-MS3A. If an error message does not disappear, restart Windows or Android device. 	RS-MS3W, RS-MS3A's instruction manual —

Section 13 DD MODE OPERATIONS

About the DD mode.....	13-2
Setting your PC	13-2
Setting the transceiver.....	13-3
◇ Connecting a LAN cable.....	13-3
◇ Setting your call sign	13-3
DD mode operation without a repeater.....	13-4
DD mode operation using a repeater	13-5
Internet access	13-6
Troubleshooting for the DD mode operation	13-7

About the DD mode

- Data communication at 128 kbps

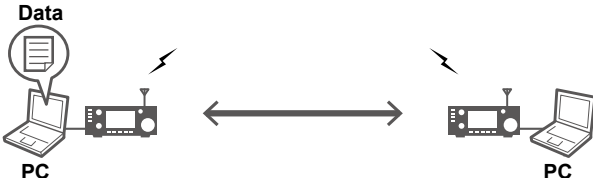

- Data can be sent through an internet connection to another station or through another repeater

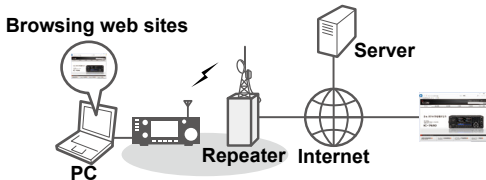
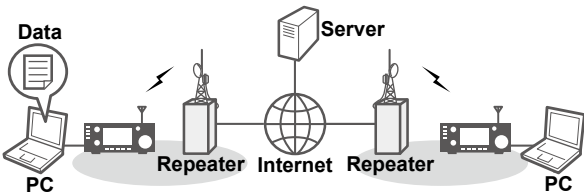

While in the DD mode and the “TX INHIBIT” is set to “OFF,” the data is automatically sent when data is input from a PC. The received data is output on the PC.

- ① Each push of **TRANSMIT** toggles the “TX INHIBIT” ON or OFF.
- ① You can change data output setting.

MENU » **SET > DV/DD Set > DD Packet Output**

① PRECAUTION

- While the transmission inhibit is OFF, files in the shared folder may be modified or deleted, or unknown file(s) may be copied into the folder by other station.
- Icom assumes no responsibility whatever for any damages or lost profits resulting from opportunities for signal communications being lost because of the failure, malfunction, poor condition, damage, or data loss of this unit or because of such external causes as power failure. Icom also dismisses all responsibility for demands made by a third party.
- Since the transmitting data is not encrypted, the data can be received and decrypted by other stations.
- Connect the IC-9700 and PC using an Ethernet cable for Data mode operation before starting the DD mode operation. (See p. 13-3.)
- Disconnecting the PC from any other network, ISP, LAN, and so on, is recommended. A network error may occur.
- For data transferring (PC-to-PC communication), a fixed IP address must be set, and folder is shared in the same workgroup between both PC.
- You cannot use the NTP Server function and DV Gateway function while operating in the DD mode.

Setting your PC

To operate in the DD mode, you need a network environment Local Area Network (LAN).

- ① The communication in the DD mode is Peer to Peer.
- ① Depending on your operating purposes, you may need to change a firewall setting, such as to allow pings, file sharing, or the FTP service. Ask your PC’s manufacturer about the setting details.
- ① After finishing DD mode operation, restore the firewall setting for security, when you use your PC to access the Internet.

1. Obtain the static IP address

Set a static IP address to your PC.

- ① Note the current IP address before you change it.

Communication without a repeater

- ① **DO NOT** set the same IP address between PCs.
- ① To prevent the transceiver from unnecessarily transmitting, we recommend connecting your PC and transceiver by using a wired LAN Adapter that is separate from the Internet connection.

Example:

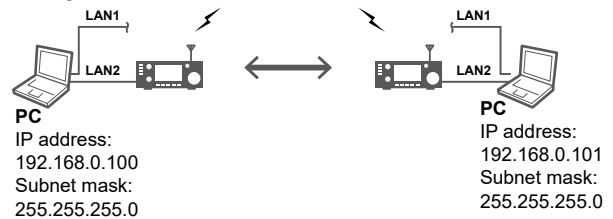

Communication using a repeater

Set the IP address, subnet mask and the repeater’s gateway address that are specified by the repeater administrator.

Example:

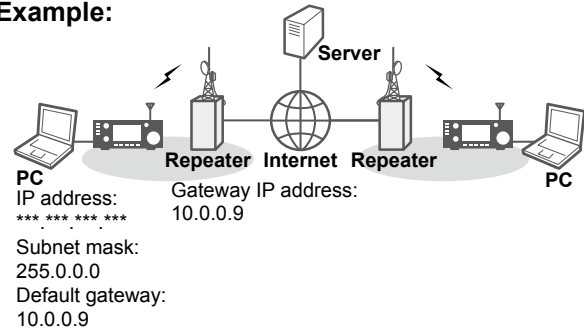

13. DD MODE OPERATIONS

Setting your PC

2. Setting the computer information

Set the computer name, workgroup name and computer description.

- ① Set the same workgroup to both PCs.
- ① Some PCs may not need the setting.

3. Setting the shared folder

- ① Ask your PC's manufacturer about the setting details.

Setting the transceiver

◇ Connecting a LAN cable

Connect the PC and IC-9700 [LAN] port using a LAN cable (User supplied).

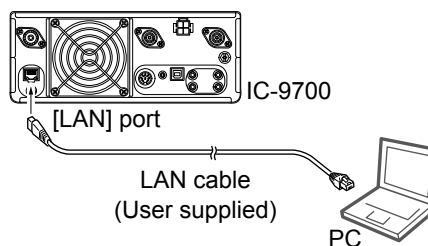

◇ Setting your call sign

Set your call sign for the DD mode operation. You can set a different call sign for the DD mode operation.

- ① You do not have to set another call sign as long as you use the same one.
- ① IC-9700's network setting is not required.

1. Display the MY CALL SIGN (DD) screen.

MENU » **SET > My Station > My Call Sign (DD)**

2. Touch the call sign that you use for the DD mode operation. (Example: JA3YUA /DD)

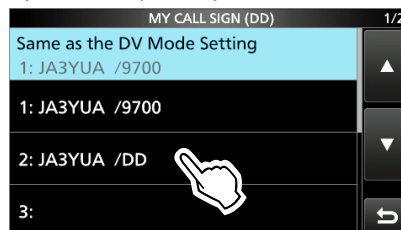

3. Push **EXIT** several times to close the MY CALL SIGN screen.

DD mode operation without a repeater

1. Set the frequency and mode

1. Set the operating frequency in the VFO mode.
(Example: 1293.100 MHz)
2. Select the DD mode.

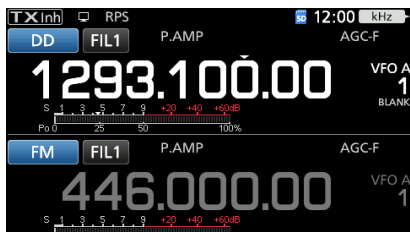

2. Set the DD repeater simplex mode to OFF

1. Push **FUNCTION**.
2. Touch (2) to change the screen page.
3. Confirm that [RPS] is set to "OFF."



- Each touch toggles the DD repeater simplex mode ON or OFF.
4. Push **EXIT** several times to close the FUNCTION screen.

3. Set the call sign

1. Display the CALL SIGN screen.

MENU » **(2) > CS**

2. Touch [UR].

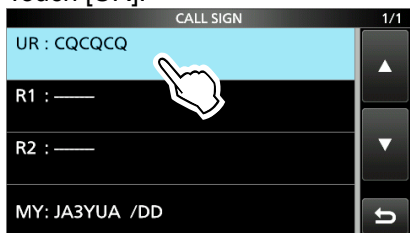

① Touch [UR] for 1 second, to directly enter the call sign.

3. Touch [Your Call Sign].

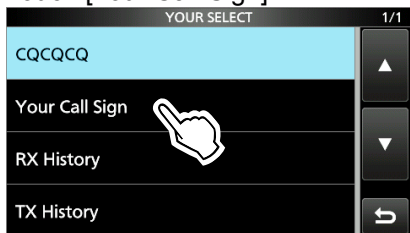

4. Touch Your Call Sign, then find and touch the call sign of the station that you want to contact.
5. Push **EXIT** several times to close the CALL SIGN screen.

4. Cancel transmit inhibit and send the data

1. Push **TRANSMIT** to set [TX INHIBIT] to "OFF."
2. Confirm that you can find the other station's shared folder on your PC.
3. Open the shared folder.
4. Drag and drop, or copy and paste the desired file on to your folder.

5. After the DD mode operation

- Push **TRANSMIT** to set [TX INHIBIT] to "ON."

Communication status indication

The communication status in the DD mode operation is displayed.

Indication	Status
	Stand-by
	Data receiving ① The received data is output to the PC. [TX/RX] lights green.
	Data sending ① The IC-9700 is transmitting data. [TX/RX] lights red.

DD mode operation using a repeater

1. Select the access repeater (FROM)

1. Set the operating band to 1200 MHz.
2. Hold down **CALL DR** for 1 second.
3. Touch **[FROM]** to select "FROM."



4. Touch [Repeater List].

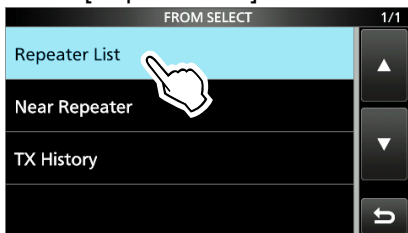

5. Touch [DD Mode].

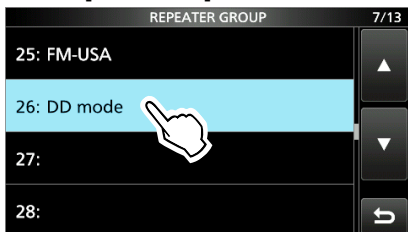

6. Touch the DD mode repeater to access.



2. Select the area repeater (TO)

1. Touch **[TO]** twice.



2. Touch **[Your Call Sign]**.
3. Touch the other station's call sign.

3. Cancel the transmit inhibit and send the data

1. Push **TRANSMIT** to set **[TX INHIBIT]** to "OFF."
2. Confirm that you can find the other station's shared folder on your PC.
3. Open the shared folder.
4. Drag and drop, or copy and paste the desired file on to the folder.

4. After the DD mode operation

- Push **TRANSMIT** to set **[TX INHIBIT]** to "ON."

Communication status indication	
The communication status in the DD mode operation is displayed.	
Indication	Status
	Stand-by
	Data receiving ① The received data is output to the PC. [TX/RX] lights green.
	Data sending ① The IC-9700 is transmitting data. [TX/RX] lights red.

Internet access

1. Select the access repeater (FROM)

1. Set the operating band to 1200 MHz.
2. Hold down **[CALLDR]** for 1 second.
3. Touch **[FROM]** to select "FROM."



4. Touch [Repeater List].

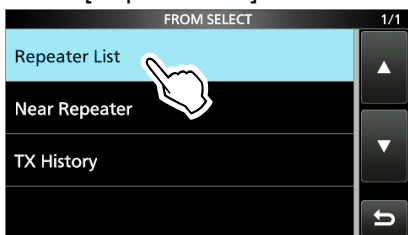

5. Touch [DD Mode].

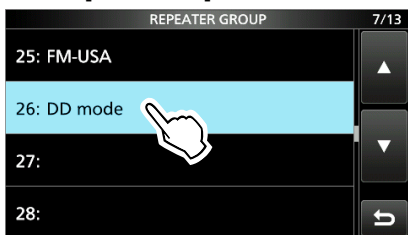

6. Touch the DD mode repeater to access.



2. Select the area repeater (TO)

1. Touch **[TO]** twice.



2. Touch **[Internet Connection]**.

3. Cancel the transmit inhibit and access the internet

1. Push **[TRANSMIT]** to set **[TX INHIBIT]** to "OFF."
2. Open a WEB browser on your PC, and then access web sites.

4. After the DD mode operation

- Push **[TRANSMIT]** to set **[TX INHIBIT]** to "ON."

Communication status indication	
The communication status in the DD mode operation is displayed.	
Indication	Status
	Stand-by
	Data receiving ① The received data is output to the PC. [TX/RX] lights green.
	Data sending ① The IC-9700 is transmitting data. [TX/RX] lights red.

13. DD MODE OPERATIONS

Troubleshooting for the DD mode operation

The following chart is designed to help you correct problems which are not equipment malfunctions.

① See also the TROUBLESHOOTING section in the BASIC MANUAL.

PROBLEM	POSSIBLE CAUSE	SOLUTION	REFERENCE
You cannot transmit or receive.	A LAN cable is not connected or is defective.	<ul style="list-style-type: none">• Check the LAN cable connection.• Replace the LAN cable.	p. 13-3
	[TX INHIBIT] is "ON."	Push [TRANSMIT] to turn OFF [TX INHIBIT].	–
You cannot share files.	Your PC settings are incorrect.	<ul style="list-style-type: none">• Check workgroup and folder sharing settings.• Check the firewall setting.	p. 13-2
You cannot connect to the Internet.	The IP address is incorrect.	Set the correct IP address.	p. 13-2

Section 14 UPDATING THE FIRMWARE

General.....	14-2
◇ About updating the firmware	14-2
◇ Checking the firmware version	14-2
◇ Preparation	14-3
◇ Unzipping the firmware folder.....	14-3
Updating the firmware	14-4

14. UPDATING THE FIRMWARE

General

◇ About updating the firmware

You can update the IC-9700's firmware using an SD card. Updating the firmware adds new functions and/or improves performance parameters.

You can download the latest firmware from the Icom website.

<https://www.icomjapan.com/support/>

IMPORTANT: To update the firmware, first format your SD card using the IC-9700. Then copy the downloaded firmware data from your PC into the IC-9700 folder on the card.

◇ Checking the firmware version

Check the firmware version when you turn ON the transceiver.



The firmware version is displayed

TIP: You can also check the firmware version on the VERSION screen.

MENU » SET > Others > Information > **Version**

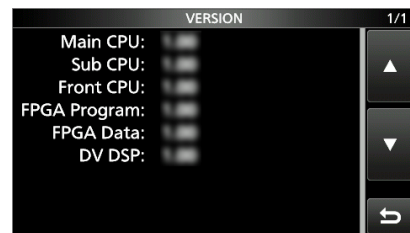

14. UPDATING THE FIRMWARE

General

◆ Preparation

Access the following URL and download the firmware file.

<https://www.icomjapan.com/support/>

① These instructions are based on Microsoft Windows 10.

1. Click the “Firmware/Software” link.

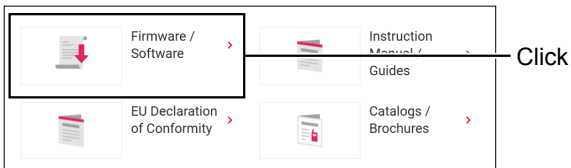

2. Enter “IC-9700” into the Search box, and then click [Search].

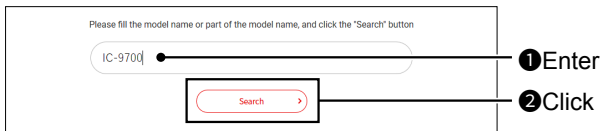

3. Click the desired firmware file link.
4. Carefully read “Regarding this Download Service.” Click “Agree,” and then click [Download].

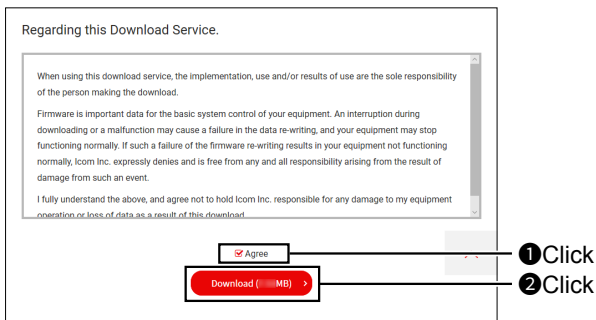

5. Click “Save as.”

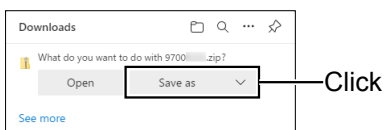

① The download procedure may differ, depending on your browser and its settings.

6. Select the location where you want to save the firmware, and then click [Save] in the displayed File Download dialog.
 - The file starts downloading.
 - The firmware and the firm utility are compressed in a “zip” format folder. Unzip it before use.

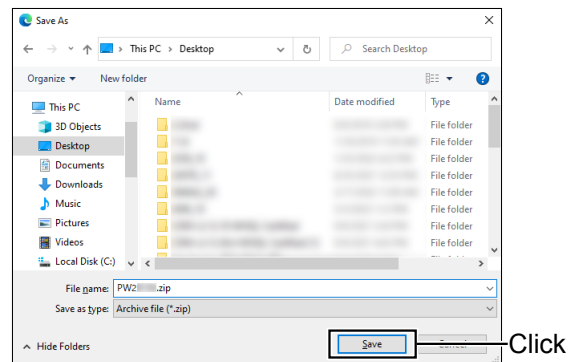

◆ Unzipping the firmware folder

1. Right-click the downloaded firmware folder (zip format).
 - Right-click menu is displayed.
2. Click “Extract All...”

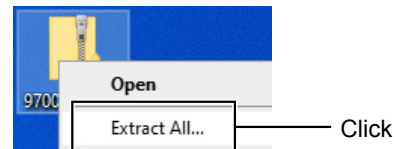

- After unzipping, a folder is created in the same location as the downloaded folder.
- ① In the “9700*” folder, “9700*.dat” is created.
* Represents the release number.

Updating the firmware

CAUTION: NEVER turn OFF the transceiver while updating the firmware. If you turn OFF the transceiver, or if a power failure occurs while updating, the transceiver firmware will be damaged and you will have to send the transceiver back to the nearest Icom distributor for repair. This type of repair is out of warranty, even if the transceiver warranty period is still valid.

TIP: BE SURE to unzip the downloaded file. See the previous page for details.

1. Copy the downloaded firmware data into the IC-9700 folder on to an SD card.

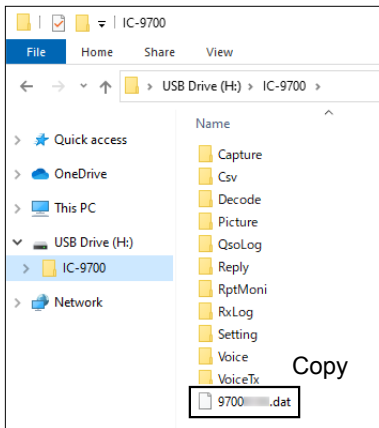

2. Insert the SD card into the transceiver.
3. Display the SD CARD screen.
MENU » **SET > SD Card**
4. Touch “Firmware Update.”

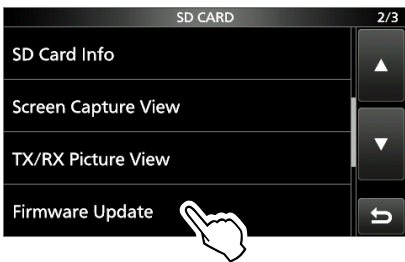

5. After you read and agree with all the precautions, touch [YES].
 - Scroll the screen and read all the precautions.
 - The confirmation dialog is displayed. When you touch [YES], the backup file is made on the SD card, and then the Firmware selection screen is displayed.

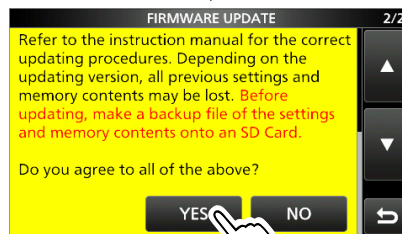
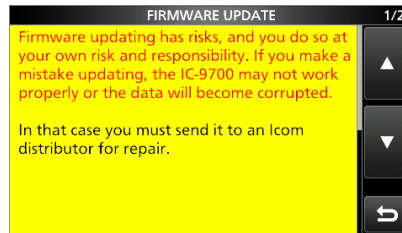

6. Touch the Firmware (Example: 9700*).
* Represents the release number.



- The final confirmation screen is displayed.
 - ⓐ Carefully read all the displayed precautions.
7. After you read and agree with all the precautions, touch [YES] for 1 second.
 - The updating starts.

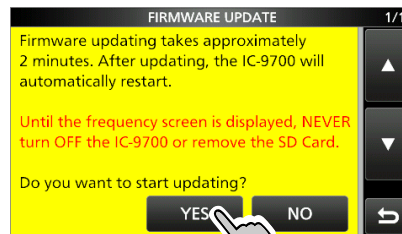

Touch for 1 second

8. When the update is completed, “Firmware updating has completed.” is displayed in the dialog.
 - The IC-9700 will automatically restart.
 - ⓐ After the updating finishes, the operating screen is displayed.

